



SINK WORKSTATIONS

CATALOGO 2023

STORIA E PASSIONE

Artinox è stata fondata nel 1985 da Mario Zanardo a Conegliano, in una fra le più importanti aree industriali italiane specializzate nella lavorazione dell'acciaio. Tutte le nostre collezioni, dedicate al mercato delle cucine di alta gamma, sono disegnate e prodotte con passione all'interno del nostro stabilimento per essere distribuite in tutto il mondo.



QUALITÀ E SOSTENIBILITÀ

Oltre alle qualità intrinseche della materia prima, siamo impegnati nell'implementazione del nostro sistema di gestione ambientale: in Artinox utilizziamo da sempre il controllo di tutti i processi per garantire il massimo risultato delle prestazioni offerte – certificazione ISO 9001 –, prendendoci cura dei fattori che interagiscono con l'ambiente – ISO 14001 –.



WORKSTATION, DESIGN INNOVATIVO

In Artinox rivoluzioniamo il tempo passato in cucina. Tutte le workstation si integrano al piano di lavoro diventando un tutt'uno: il sistema sliding permette il posizionamento e lo scorrimento di infiniti accessori dedicati a molteplici funzionalità, dalle griglie ai supporti, dai taglieri ai contenitori fatti per durare e per servire con un semplice gesto.



IL NOSTRO ACCIAIO

Il nostro acciaio è inossidabile ed è utilizzato in ambienti sia domestici che professionali, conforme a tutti gli standard di settore. È estremamente facile da pulire grazie alla superficie priva di pori, che comporta un'alta proprietà antibatterica. Il nostro acciaio è inalterabile nel tempo, è composto per oltre il 70% da materiali riciclati ed è riciclabile al 100%.





DETTAGLI CHE FANNO LA DIFFERENZA

Accessori dedicati

Gli accessori in acciaio inox, sempre prodotti in alto spessore nei nostri stabilimenti, sono lavabili in lavastoviglie. I taglieri sono in legno o in polietilene atossico.



Acciaio di alto spessore

Utilizziamo acciaio inossidabile AISI 304 di spessore maggiorato rispetto ai normali standard di mercato, garantendo prodotti robusti dal design unico.



Vasche saldate

In Artinox produciamo esclusivamente workstation e lavelli con processo di saldatura, con angoli raggiati di 10 mm o a raggio zero, per un design contemporaneo.



Dimensioni capienti

Tutte le nostre collezioni hanno vasche di diverse dimensioni e una profondità minima di 200 mm, garantendo grande capienza e praticità operativa.

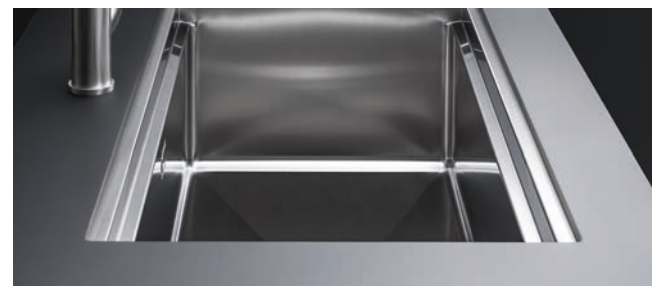

Fori miscelatori

Tutti i modelli delle nostre collezioni sono predisposti con uno o due fori diametro 35 mm per l'alloggio del miscelatore. È possibile richiedere fori aggiuntivi.



Kit saltarello

I pratici kit saltarello push, in abbinamento alle pilette, evitano di bagnarsi le mani per svuotare le vasche piene d'acqua. Prodotti da selezionati partner italiani.



Troppopieno

Tutte le nostre vasche hanno il troppopieno integrato sulla parete posteriore e sono progettate senza giunture in modo da garantire la massima igiene.



Fondi inclinati

Il deflusso dell'acqua è sempre garantito da un invito in prossimità della piletta e, in specifiche collezioni, anche da eleganti fondi vasca diamantati.



Pilette 3 1/2"

Le esclusive pilette dei nostri modelli sono prodotti da selezionati partner italiani. Tutti i modelli, le varianti e le colorazioni sono sempre in acciaio inox.



Sifoni salvaspazio

Il sifone salvaspazio è un accessorio disponibile per tutte le nostre collezioni. Le dimensioni contenute e la facile orientabilità aumentano lo spazio sotto il lavello.

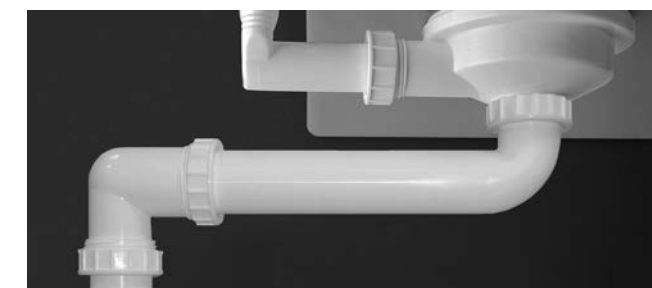

UN ALLESTIMENTO PER OGNI STILE

Sopratop

Il sopratop permette sempre la facile installazione del lavello su piani di qualsiasi materiale.



Filotop

L'elegante perimetro a vista filotop ha il bordo rettificato con una tolleranza di due decimi.



Sottotop

La soluzione sottotop permette di sfruttare al massimo la superficie del piano di lavoro.

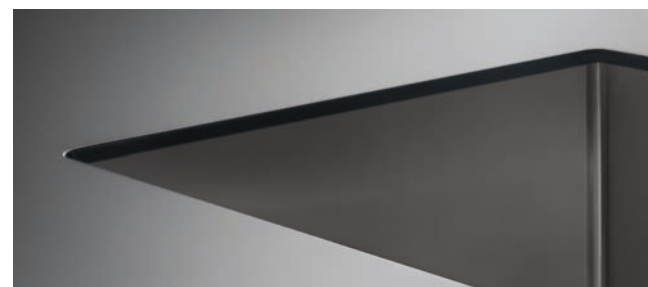

Edgeless

Con Edgeless i bordi e le giunzioni tra vasca e piano spariscono, ottenendo estetica e igiene.

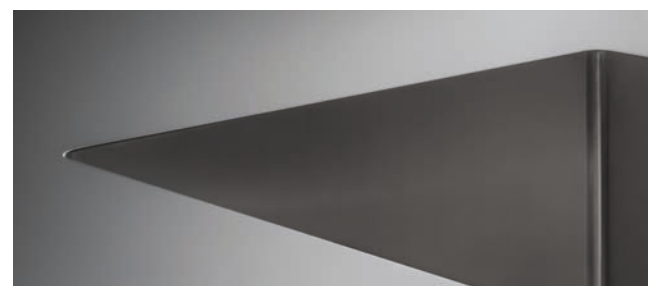

Fondo Integrato

L'innovativa installazione con fondo in inox e pareti in continuità con il piano di lavoro.



INDICE

WORKSTATIONS

PLANUM	18
NEWGO	36
LAYER	50

SINKS

TITANIUM	76
RADIUS	92
GHOST	110
MOSE	114
AQUA	122
PRISMA	130
LINEA	142
SHORE	152

MISCELATORI	162
-------------	-----

COMPLEMENTI	170
-------------	-----

PRODOTTI PER LA PULIZIA	172
-------------------------	-----

CONDIZIONI DI VENDITA	174
-----------------------	-----

PLANUM



PLANUM XL

La workstation in acciaio inox dalle grandi dimensioni, per goderti al meglio il tempo in cucina. Il sistema sliding permette il posizionamento e lo scorrimento di infiniti accessori dedicati a molteplici funzionalità: dalle griglie ai supporti, dai taglieri ai contenitori. Per durare e per servire con un semplice gesto.



PLANUM XL 111

READY

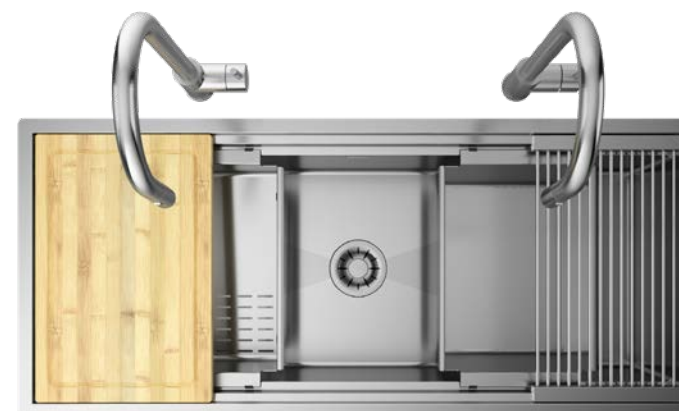

- Tagliere in legno **1**
- Vaschetta inclinata forata **23**
- Vaschetta **26**
- Griglia **10**
- Miscelatore Loft **38**
- Miscelatore Loft **38**

 Sopratop Cod. **SAP I 11** € 4.281,00

PLANUM XL 111

PRO



- Tagliere in legno **1**
- Vaschetta inclinata forata **23**

 Sopratop Cod. **SBP I 11** € 2.020,00

PLANUM XL 111

SOLO



- Materiale AISI 304
- Finitura Spazzolato
- Raggio interno Saldato 10 mm
- Misure esterne 1160 × 510 mm
- Misure vasca 1110 × 400 mm
- Profondità vasca 254 mm
- Piletta Plus Ø 3 ½"
- Base 1200 mm

 Sopratop Cod. **PI 11 4025** € 1.620,00

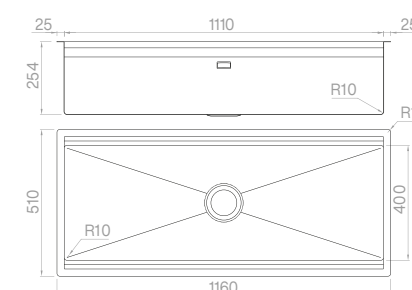



Accessori

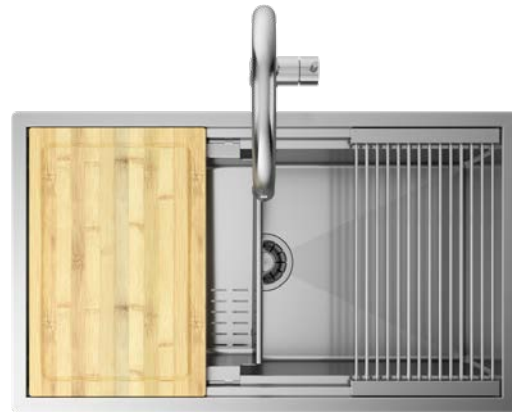

Vedi pag. 25 per tutti gli accessori dedicati.

PLANUM XL 81 **READY**



- Tagliere in legno **1**
 - Vaschetta inclinata forata **23**
 - Griglia **10**
 - Miscelatore Loft **38**
-  Sopratop Cod. **SAP I 81** € 2.842,00

PLANUM XL 70 **READY**



- Tagliere in legno **1**
 - Vaschetta inclinata forata **23**
 - Griglia **10**
 - Miscelatore Loft **38**
-  Sopratop Cod. **SAP I 70** € 2.775,00

PLANUM XL 81 **PRO**



- Tagliere in legno **1**
 - Vaschetta inclinata forata **23**
-  Sopratop Cod. **SBP I 81** € 1.708,00

PLANUM XL 70 **PRO**



- Tagliere in legno **1**
 - Vaschetta inclinata forata **23**
-  Sopratop Cod. **SBP I 70** € 1.641,00

PLANUM XL 81 **SOLO**



- | | |
|------------------|---------------|
| Materiale | AISI 304 |
| Finitura | Spazzolato |
| Raggio interno | Saldato 10 mm |
| Misure esterne | 860 × 510 mm |
| Misure vasca | 810 × 400 mm |
| Profondità vasca | 254 mm |
| Piletta Plus | Ø 3 ½" |
| Base | 900 mm |
-  Sopratop Cod. **PI 81 4025** € 1.308,00

PLANUM XL 70 **SOLO**



- | | |
|------------------|---------------|
| Materiale | AISI 304 |
| Finitura | Spazzolato |
| Raggio interno | Saldato 10 mm |
| Misure esterne | 750 × 510 mm |
| Misure vasca | 700 × 400 mm |
| Profondità vasca | 254 mm |
| Piletta Plus | Ø 3 ½" |
| Base | 800 mm |
-  Sopratop Cod. **PI 70 4025** € 1.241,00

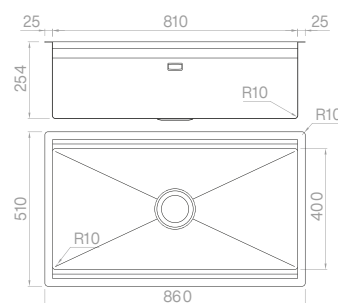

Accessori



Vedi pag. 25 per tutti gli accessori dedicati.

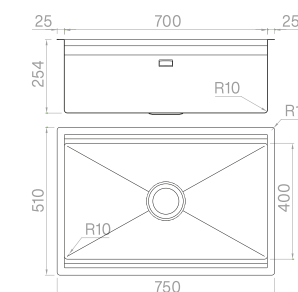

Accessori



Vedi pag. 25 per tutti gli accessori dedicati.

**Tagliere in legno****1**

300×457×20 mm

Cod. **TRIB 3045**

€ 158,00

**Tagliere in HDPE****6**

240×427×20 mm

Cod. **TRP 2442**

€ 149,00

**Set porta bottiglie****7**

130×457×170 mm

Cod. **VPB 3C**

€ 340,00

**Gocciolatoio****8**

250×457×15 mm

Cod. **VPB 2545**

€ 170,00

**Griglia****10**

300×457×25 mm

Cod. **GRS 3045**

€ 281,00

**Vaschetta forata****16**

210×420×60 mm

Cod. **VQSF 2142**

€ 204,00

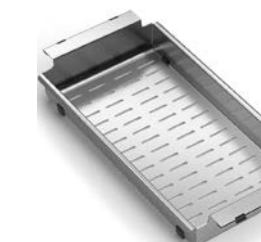
**Vaschetta inclinata forata****23**

280×420×110/60 mm

Cod. **VQSI 2842**

€ 242,00

**Vaschetta****26**

280×420×160 mm

Cod. **VQSP 2842**

€ 274,00

**Set gastronorm****30**

240×420×100 mm

Cod. **TI 2442 V**

€ 221,50

**Set scolapasta****32**

240×420×100 mm

Cod. **TI 2442 1S**

€ 170,00

**Set grattugie****34**

240×420×28 mm

Cod. **TI 2442 PG**

€ 351,00

**Porta piatti****36**

250×420×55 mm

Cod. **PPPB V400**

€ 182,00



PLANUM BR

Tutte le workstation Planum si caratterizzano per il doppio livello di scorrimento. Molteplici combinazioni fra accessori garantiscono la massima personalizzazione dell'area operativa.



PLANUM BR 111

READY



- Tagliere in legno **2**
- Vaschetta inclinata forata **25**
- Vaschetta **27**
- Griglia **11**
- Miscelatore Loft **38**

 Sopratop Cod. **SAP BRI 11** € 3.241,00

PLANUM BR 111

PRO



- Tagliere in legno **2**
- Vaschetta inclinata forata **25**

 Sopratop Cod. **SBP BRI 11** € 1.875,00

PLANUM BR 111

SOLO



- | | |
|------------------|---------------|
| Materiale | AISI 304 |
| Finitura | Spazzolato |
| Raggio interno | Saldato 10 mm |
| Misure esterne | 1160 × 505 mm |
| Misure vasca | 1110 × 350 mm |
| Profondità vasca | 224 mm |
| Piletta Plus | Ø 3 1/2" |
| Base | 1200 mm |

 Sopratop Cod. **ALP BRI 11** € 1.507,00

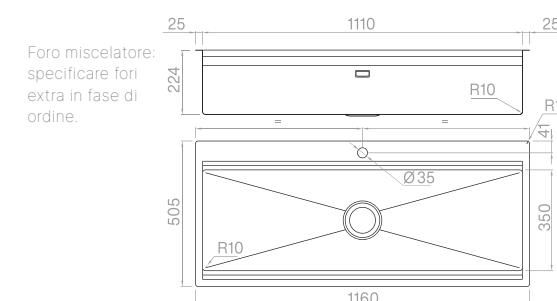

Accessori



Vedi pag. 35 per tutti gli accessori dedicati.

PLANUM BR 81 **READY**

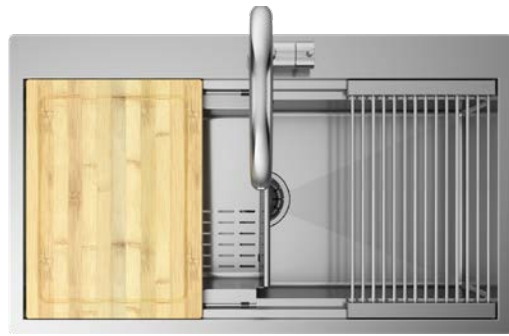

- Tagliere in legno **2**
- Vaschetta inclinata forata **25**
- Griglia **11**
- Miscelatore Loft **38**

 Sopratop Cod. **SAP BRI 81** € 2.698,00

PLANUM BR 70 **READY**

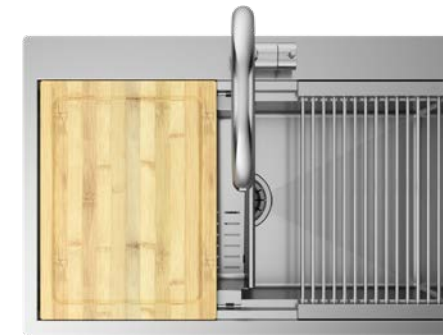

- Tagliere in legno **2**
- Vaschetta inclinata forata **25**
- Griglia **11**
- Miscelatore Loft **38**

 Sopratop Cod. **SAP BRI 70** € 2.636,00

PLANUM BR 81 **PRO**



- Tagliere in legno **2**
- Vaschetta inclinata forata **25**

 Sopratop Cod. **SBP BRI 81** € 1.585,00

PLANUM BR 70 **PRO**



- Tagliere in legno **2**
- Vaschetta inclinata forata **25**

 Sopratop Cod. **SBP BRI 70** € 1.523,00

PLANUM BR 81 **SOLO**



- | | |
|------------------|---------------|
| Materiale | AISI 304 |
| Finitura | Spazzolato |
| Raggio interno | Saldato 10 mm |
| Misure esterne | 860 × 505 mm |
| Misure vasca | 810 × 350 mm |
| Profondità vasca | 224 mm |
| Piletta Plus | Ø 3 ½" |
| Base | 900 mm |

 Sopratop Cod. **ALP BRI 81** € 1.217,00

PLANUM BR 70 **SOLO**



- | | |
|------------------|---------------|
| Materiale | AISI 304 |
| Finitura | Spazzolato |
| Raggio interno | Saldato 10 mm |
| Misure esterne | 750 × 505 mm |
| Misure vasca | 700 × 350 mm |
| Profondità vasca | 224 mm |
| Piletta Plus | Ø 3 ½" |
| Base | 800 mm |

 Sopratop Cod. **ALP BRI 70** € 1.155,00

Foro miscelatore: specificare fori extra in fase di ordine.

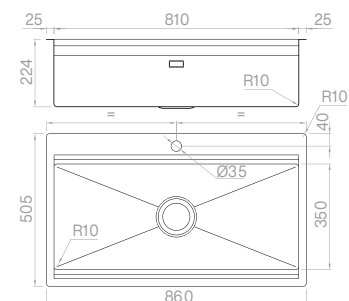

Accessori



Vedi pag. 35 per tutti gli accessori dedicati.

Foro miscelatore: specificare fori extra in fase di ordine.

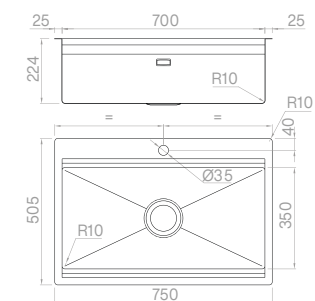

Accessori



Vedi pag. 35 per tutti gli accessori dedicati.

PLANUM ST

La funzionalità della collezione Planum in uno spazio più contenuto. L'installazione sottotop permette di sfruttare al massimo la superficie del piano di lavoro.



PLANUM ST 111

READY



- Tagliere in legno 2
- Vaschetta inclinata forata 25
- Vaschetta 27
- Griglia 11
- Miscelatore Loft 38

Sottotop Cod. **SAPO 11 L1** € 3.019,00

PLANUM ST 111

PRO



- Tagliere in legno 2
- Vaschetta inclinata forata 25

Sottotop Cod. **SBPO 11 L1** € 1.653,00

PLANUM ST 111

SOLO



- | | |
|------------------|---------------|
| Materiale | AISI 304 |
| Finitura | Spazzolato |
| Raggio interno | Saldato 10 mm |
| Misure esterne | 1150 × 440 mm |
| Misure vasca | 1110 × 350 mm |
| Profondità vasca | 224 mm |
| Piletta Plus | Ø 3 ½" |
| Base | 1200 mm |

Sottotop Cod. **PO 11 L1** € 1.285,00

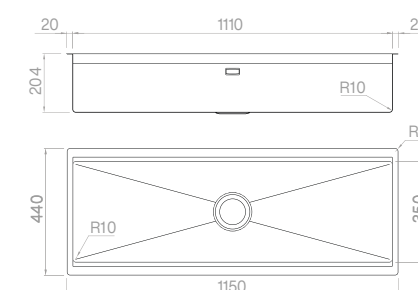

Accessori



Vedi pag. 35 per tutti gli accessori dedicati.

PLANUM ST 81 **READY**

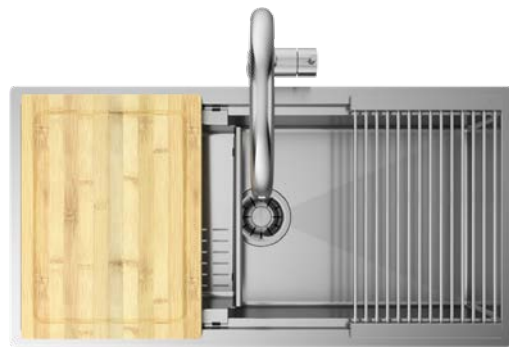

- Tagliere in legno **2**
- Vaschetta inclinata forata **25**
- Griglia **11**
- Miscelatore Loft **38**

Sottotop Cod. **SAPO 81 L1** € 2.482,00

PLANUM ST 81 **PRO**



- Tagliere in legno **2**
- Vaschetta inclinata forata **25**

Sottotop Cod. **SBPO 81 L1** € 1.369,00

PLANUM ST 81 **SOLO**



- | | |
|------------------|---------------|
| Materiale | AISI 304 |
| Finitura | Spazzolato |
| Raggio interno | Saldato 10 mm |
| Misure esterne | 850 × 440 mm |
| Misure vasca | 810 × 350 mm |
| Profondità vasca | 224 mm |
| Piletta Plus | Ø 3 ½" |
| Base | 900 mm |

Sottotop Cod. **PO 81 L1** € 1.001,00

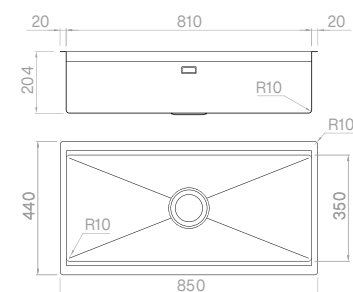

Accessori

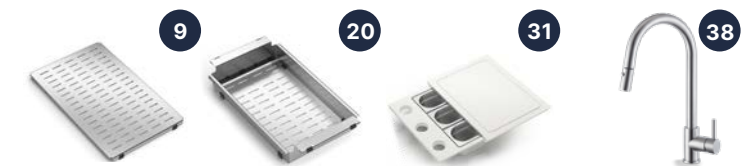

Vedi pag. 35 per tutti gli accessori dedicati.

PLANUM ST 70 **READY**

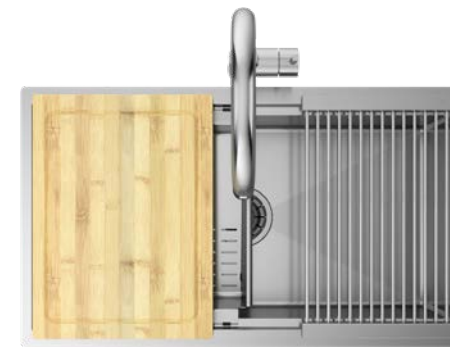

- Tagliere in legno **2**
- Vaschetta inclinata forata **25**
- Griglia **11**
- Miscelatore Loft **38**

Sottotop Cod. **SAPO 70 L1** € 2.431,00

PLANUM ST 70 **PRO**



- Tagliere in legno **2**
- Vaschetta inclinata forata **25**

Sottotop Cod. **SBPO 70 L1** € 1.318,00

PLANUM ST 70 **SOLO**



- | | |
|------------------|---------------|
| Materiale | AISI 304 |
| Finitura | Spazzolato |
| Raggio interno | Saldato 10 mm |
| Misure esterne | 740 × 440 mm |
| Misure vasca | 700 × 350 mm |
| Profondità vasca | 224 mm |
| Piletta Plus | Ø 3 ½" |
| Base | 800 mm |

Sottotop Cod. **PO 70 L1** € 950,00

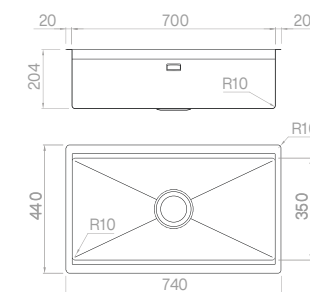

Accessori



Vedi pag. 35 per tutti gli accessori dedicati.

**Tagliere in legno****2**

300×407×20 mm

Cod. **TRIB 3041**

€ 137,00

**Gocciolatoio****9**

250×407×15 mm

Cod. **VPB 2541**

€ 149,00

**Griglia****11**

300×407×25 mm

Cod. **GRS 3041**

€ 260,00

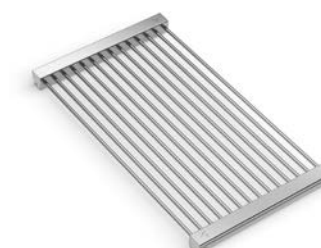
**Vaschetta forata****20**

210×375×60 mm

Cod. **VQSF 2137**

€ 189,00

**Vaschetta inclinata forata****25**

280×370×110/60 mm

Cod. **VQSI 2837**

€ 231,00

**Vaschetta****27**

280×370×140 mm

Cod. **VQSP 2837**

€ 253,00

**Set tagliere + gastronorm****31**

300×405×100 mm

Cod. **TPLB 3V**

€ 421,20

**Set tagliere + colapasta****33**

300×405×100 mm

Cod. **TPLB 1S**

€ 371,00

**Set tagliere + telaio porta coltelli****35**

300×405×20 mm

Cod. **TPLB 4030**

€ 328,00





NEWGO MATTE VINTAGE

Una workstation elegante e sofisticata grazie all'abbinamento fra l'acciaio Matte Vintage e la finitura nera dei miscelatori e degli accessori.





NEWGO 81 MATTE VINTAGE

READY



- Griglia matte vintage **13**
- Vaschetta inclinata forata matte vintage **24**
- Miscelatore Ergo **41**



 Sopratop	Cod. SAG I 81H	€ 2.645,00
 Filotop	Cod. SAGG 81H	€ 2.645,00

NEWGO 81 MATTE VINTAGE

PRO





- Griglia matte vintage **13**

 Sopratop	Cod. SBG I 81H	€ 1.748,00
 Filotop	Cod. SBGG 81H	€ 1.748,00

NEWGO 81 MATTE VINTAGE

SOLO



Materiale	AISI 304
Finitura	Spazzolato opaco
Raggio interno	Saldato 10 mm
Misure esterne	850 × 530 mm
Misure vasca	810 × 400 mm
Profondità vasca	220 mm
Piletta nera	Ø 3 1/2"
Salterello nero	incluso
Base	900 mm
 Sopratop	Cod. ALG I 81H € 1.448,00
 Filotop	Cod. ALGG 81H € 1.448,00

Foro miscelatore: specificare fori extra in fase di ordine.

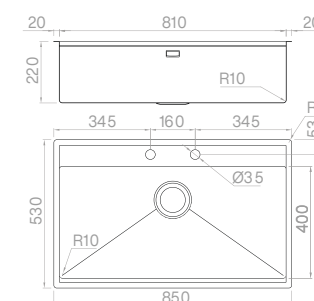

Accessori



Vedi pag. 43 per tutti gli accessori dedicati.

NEWGO 70 MATTE VINTAGE

READY



- Griglia matte vintage
- Vaschetta inclinata forata matte vintage
- Miscelatore Ergo

13
24
41



Cod. **SAG I 70H** € 2.492,00
Cod. **SAGG 70H** € 2.492,00

NEWGO 70 MATTE VINTAGE

PRO

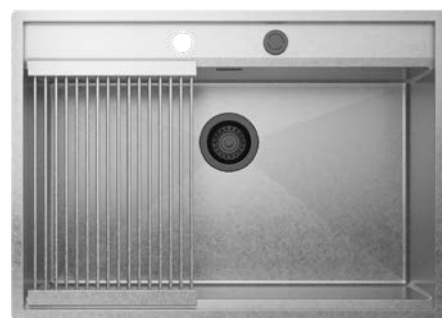

- Griglia matte vintage

13



Cod. **SBG I 70H** € 1.595,00
Cod. **SBGG 70H** € 1.595,00

NEWGO 70 MATTE VINTAGE

SOLO



- Materiale AISI 304
- Finitura Spazzolato opaco
- Raggio interno Saldato 10 mm
- Misure esterne 740 × 530 mm
- Misure vasca 700 × 400 mm
- Profondità vasca 220 mm
- Piletta nera Ø 3 1/2"
- Salterello nero incluso
- Base 800 mm



Cod. **ALG I 70H** € 1.295,00
Cod. **ALGG 70H** € 1.295,00

Foro miscelatore: specificare fori extra in fase di ordine.

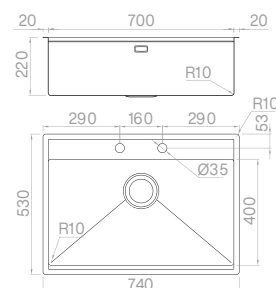

Accessori



Vedi pag. 43 per tutti gli accessori dedicati.

NEWGO 65 MATTE VINTAGE

READY



- Griglia matte vintage
- Vaschetta inclinata forata matte vintage
- Miscelatore Ergo

13
24
41



Cod. **SAG I 65H** € 2.417,00
Cod. **SAGG 65H** € 2.417,00

NEWGO 65 MATTE VINTAGE

PRO

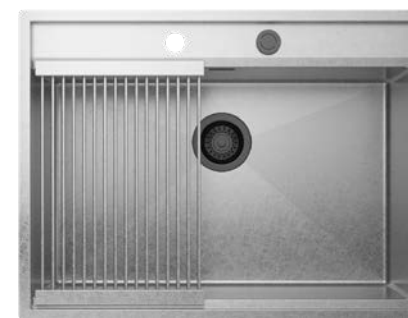

- Griglia matte vintage

13



Cod. **SBG I 65H** € 1.520,00
Cod. **SBGG 65H** € 1.520,00

NEWGO 65 MATTE VINTAGE

SOLO



- Materiale AISI 304
- Finitura Spazzolato opaco
- Raggio interno Saldato 10 mm
- Misure esterne 690 × 530 mm
- Misure vasca 650 × 400 mm
- Profondità vasca 220 mm
- Piletta nera Ø 3 1/2"
- Salterello nero incluso
- Base 750 mm



Cod. **ALG I 65H** € 1.220,00
Cod. **ALGG 65H** € 1.220,00

Foro miscelatore: specificare fori extra in fase di ordine.

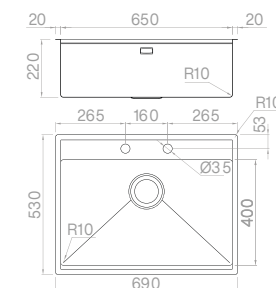

Accessori



Vedi pag. 43 per tutti gli accessori dedicati.

Tagliere in legno**3**300×420×20 mm
Cod. **TRIB 3042**

€ 137,00

**Tagliere in HDPE****6**240×427×20 mm
Cod. **TRP 2442**

€ 149,00

**Griglia matte vintage****13**250×420×25 mm
Cod. **GRH 2542**

€ 300,00

**Vaschetta inclinata forata matte vintage****24**280×420×110/60 mm
Cod. **VQHI 2842**

€ 278,00

**Set gastronorm****30**240×420×100 mm
Cod. **TI 2442 V**

€ 221,50

**Set colapasta****32**240×420×100 mm
Cod. **TI 2442 1S**

€ 170,00

**Set grattugie****34**240×420×28 mm
Cod. **TI 2442 PG**

€ 351,00

**Porta piatti****36**250×420×55 mm
Cod. **PPPB V400**

€ 182,00



NEWGO

La profondità maggiorata e il ribassamento perimetrale consentono l'alloggiamento del miscelatore all'interno dell'area operativa.



NEWGO 81

READY



- Griglia 12
- Vaschetta inclinata forata 23
- Miscelatore Circle 45

- Sopratop Cod. **SAG I 81** € 2.401,00
- Filotop Cod. **SAGG 81** € 2.401,00

NEWGO 81

PRO



- Griglia 12

- Sopratop Cod. **SBG I 81** € 1.519,00
- Filotop Cod. **SBGG 81** € 1.519,00

NEWGO 81

SOLO



- Materiale AISI 304
- Finitura Spazzolato
- Raggio interno Saldato 10 mm
- Misure esterne 850 × 530 mm
- Misure vasca 810 × 400 mm
- Profondità vasca 220 mm
- Piletta standard Ø 3 1/2"
- Salterello standard -
- Base 900 mm
- Sopratop Cod. **ALG I 81** € 1.259,00
- Filotop Cod. **ALGG 81** € 1.259,00

Foro miscelatore: specificare fori extra in fase di ordine.

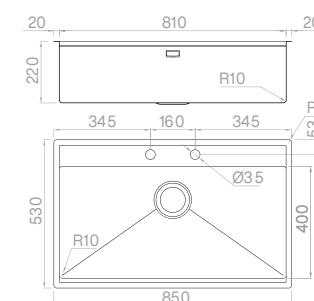

Accessori



Vedi pag. 49 per tutti gli accessori dedicati.

NEWGO 70

READY

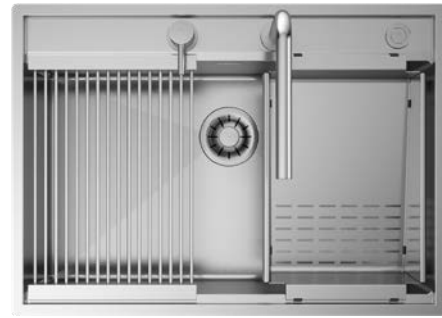

Griglia
Vaschetta inclinata forata
Miscelatore Circle

12
23
45



Cod. **SAG I 70** € 2.269,00
Cod. **SAGG 70** € 2.269,00

NEWGO 70

PRO



Supporto grigliato

12



Cod. **SBG I 70** € 1.387,00
Cod. **SBGG 70** € 1.387,00

NEWGO 70

SOLO



Materiale	AISI 304
Finitura	Spazzolato
Raggio interno	Saldato 10 mm
Misure esterne	740 × 530 mm
Misure vasca	700 × 400 mm
Profondità vasca	220 mm
Piletta standard	Ø 3 1/2"
Salterello standard	-
Base	800 mm

Cod. **ALG I 70** € 1.127,00
 Cod. **ALGG 70** € 1.127,00

NEWGO 65

READY



Griglia
Vaschetta inclinata forata
Miscelatore Circle

12
23
45



Cod. **SAG I 65** € 2.203,00
Cod. **SAGG 65** € 2.203,00

NEWGO 65

PRO



Griglia

12



Cod. **SBG I 65** € 1.321,00
Cod. **SBGG 65** € 1.321,00

NEWGO 65

SOLO



Materiale	AISI 304
Finitura	Spazzolato
Raggio interno	Saldato 10 mm
Misure esterne	690 × 530 mm
Misure vasca	650 × 400 mm
Profondità vasca	220 mm
Piletta standard	Ø 3 1/2"
Salterello standard	-
Base	750 mm

Cod. **ALG I 65** € 1.061,00
 Cod. **ALGG 65** € 1.061,00

Foro miscelatore:
specificare fori extra
in fase di ordine.

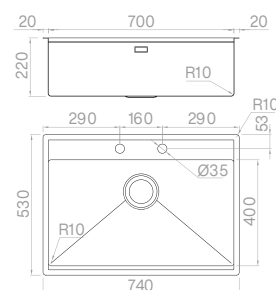

Accessori



Vedi pag. 49 per tutti gli accessori dedicati.

Foro miscelatore:
specificare fori extra
in fase di ordine.

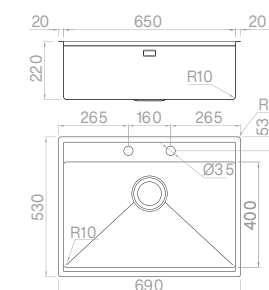

Accessori



Vedi pag. 49 per tutti gli accessori dedicati.

Tagliere in legno**3**

300×420×20 mm

Cod. **TRIB 3042**

€ 137,00

**Tagliere in HDPE****6**

240×427×20 mm

Cod. **TRP 2442**

€ 149,00

**Griglia****12**

250×420×25 mm

Cod. **GRS 2542**

€ 260,00

**Set vaschetta forata****16**

210×420×60 mm

Cod. **VQSF 2142**

€ 204,00

**Vaschetta forata inclinata****23**

280×420×110/60 mm

Cod. **VQSI 2842**

€ 242,00

**Vaschetta****26**

280×420×160 mm

Cod. **VQSP 2842**

€ 274,00

**Set gastronorm****30**

240×420×100 mm

Cod. **TI 2442 V**

€ 221,50

**Set scolapasta****32**

240×420×100 mm

Cod. **TI 2442 1S**

€ 170,00

**Set grattugie****34**

240×420×28 mm

Cod. **TI 2442 PG**

€ 351,00

**Porta piatti****36**

250×420×55 mm

Cod. **PPPB V400**

€ 182,00



LAYER



LAYER BRL

Un'estetica essenziale e funzionale grazie all'ampia profondità che aumenta la capienza.

Tutto è contenuto all'interno dello spazio e ogni accessorio scorre perfettamente allineato al piano di lavoro.





LAYER BRL 104 **READY**



- Tagliere in legno
- Vaschetta forata
- Griglia
- Miscelatore Element

- 4
- 48
- 14
- 40



 Sopratop Cod. **SA BRL I 10** € 2.894,00
 Sottotop Cod. **SA BRLO 10** € 2.686,00

LAYER BRL 74 **READY**



- Tagliere in legno
- Vaschetta forata
- Miscelatore Element

- 4
- 48
- 40



 Sopratop Cod. **SA BRL I 74** € 2.392,00
 Sottotop Cod. **SA BRLO 74** € 2.247,00

LAYER BRL 104 **PRO**



- Tagliere in legno
- Vaschetta forata

- 4
- 48



 Sopratop Cod. **SB BRL I 10** € 1.803,00
 Sottotop Cod. **SB BRLO 10** € 1.595,00

LAYER BRL 74 **PRO**



- Tagliere in legno



- 4

 Sopratop Cod. **SB BRL I 74** € 1.206,00
 Sottotop Cod. **SB BRLO 74** € 1.061,00

LAYER BRL 104 **SOLO**





- | | |
|------------------|---------------|
| Materiale | AISI 304 |
| Finitura | Spazzolato |
| Raggio interno | Raggio '0' |
| Misure esterne | 1080 × 510 mm |
| Misure vasca | 960 × 410 mm |
| Profondità vasca | 230 mm |
| Piletta Plus | Ø 3 1/2" |
| Base | 1200 mm |

 Sopratop Cod. **AL BRL I 10** € 1.282,00
 Sottotop Cod. **AL BRLO 10** € 1.074,00

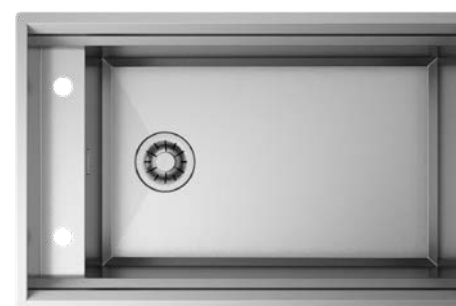
LAYER BRL 74 **SOLO**



- | | |
|------------------|--------------|
| Materiale | AISI 304 |
| Finitura | Spazzolato |
| Raggio interno | Raggio '0' |
| Misure esterne | 780 × 510 mm |
| Misure vasca | 660 × 410 mm |
| Profondità vasca | 230 mm |
| Piletta Plus | Ø 3 1/2" |
| Base | 900 mm |

 Sopratop Cod. **AL BRL I 74** € 1.044,00
 Sottotop Cod. **AL BRLO 74** € 899,00

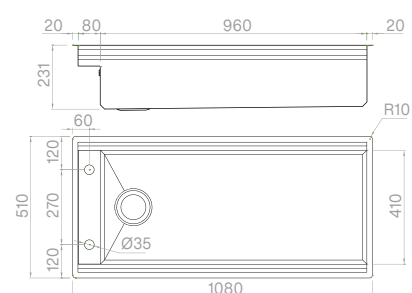

Accessori

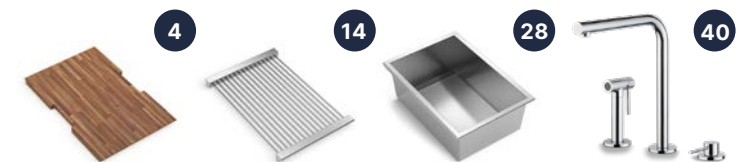

Vedi pag. 57 per tutti gli accessori dedicati.

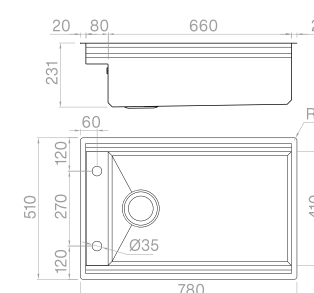

Accessori

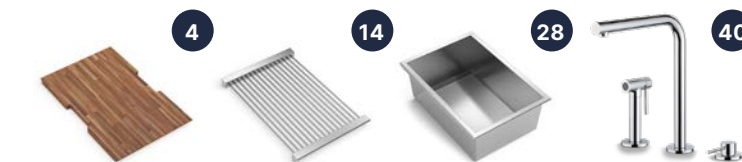

Vedi pag. 57 per tutti gli accessori dedicati.

Tagliere in legno**4**

345×465×25 mm

Cod. **TBRL 4634**

€ 162,00

**Griglia****14**

300×465×25 mm

Cod. **GFL 4630**

€ 264,00

**Vaschetta forata****21**

190×435×80 mm

Cod. **VFPB RL19**

€ 342,00

**Vaschetta****28**

345×435×160 mm

Cod. **VGB RL34**

€ 373,00

**Vaschetta forata****48**

345×435×80 mm

Cod. **VFGB RL34**

€ 359,00



LAYER BRP

Un design esclusivo, con un sistema di involucri inclinati dove accessori dedicati scorrono su due livelli. Il più alto è dedicato a griglie e taglieri mentre, appena sotto, trovano posizione vaschette e contenitori, ottenendo la massima funzionalità.



LAYER BRP 104

READY



- Tagliere in legno
- Vaschetta forata
- Griglia
- Miscelatore Element

- 5
- 49
- 15
- 40

 Sopratop

Cod. **SA BRP 104**

€ 2.699,00

LAYER BRP 104

PRO



- Tagliere in legno
- Vaschetta forata

- 5
- 49

 Sopratop

Cod. **SB BRP 104**

€ 1.629,00

LAYER BRP 104

SOLO



Materiale	AISI 304
Finitura	Spazzolato
Raggio interno	Raggio '0'
Misure esterne	1080 × 510 mm
Misure vasca	1040 × 350 mm
Profondità vasca	210 mm
Piletta Plus	Ø 3 1/2"
Base	1200 mm

 Sopratop

Cod. **AL BRP 104**

€ 1.148,00

Foro miscelatore:
specificare fori
extra in fase di
ordine.

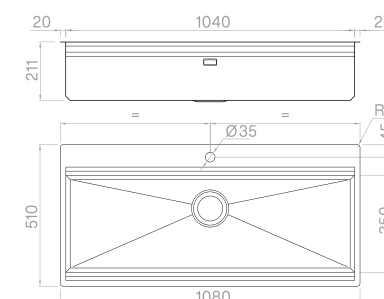

Accessori



Vedi pag. 75 per tutti gli accessori dedicati.

LAYER BRP 81 **READY**



- Tagliere in legno
- Vaschetta forata
- Griglia
- Miscelatore Vertigo

- 5
- 49
- 15
- 47

 Soprato Cod. **SA BRP 81** € 2.353,00

LAYER BRP 70 **READY**



- Tagliere in legno
- Vaschetta forata
- Griglia
- Miscelatore Vertigo

- 5
- 22
- 15
- 47

 Soprato Cod. **SA BRP 70** € 2.279,00

LAYER BRP 81 **PRO**



- Tagliere in legno
- Vaschetta forata

- 5
- 49

 Soprato Cod. **SB BRP 81** € 1.442,00

LAYER BRP 70 **PRO**



- Tagliere in legno
- Vaschetta forata

- 5
- 22

 Soprato Cod. **SB BRP 70** € 1.368,00

LAYER BRP 81 **SOLO**



Materiale	AISI 304
Finitura	Spazzolato
Raggio interno	Raggio '0'
Misure esterne	850 × 510 mm
Misure vasca	810 × 350 mm
Profondità vasca	210 mm
Piletta Plus"	Ø 3 1/2"
Base	900 mm

 Soprato Cod. **AL BRP 81** € 961,00

LAYER BRP 70 **SOLO**



Materiale	AISI 304
Finitura	Spazzolato
Raggio interno	Raggio '0'
Misure esterne	740 × 510 mm
Misure vasca	700 × 350 mm
Profondità vasca	210 mm
Piletta Plus	Ø 3 1/2"
Base	800 mm

 Soprato Cod. **AL BRP 70** € 908,00

Foro miscelatore:
specificare fori extra
in fase di ordine.

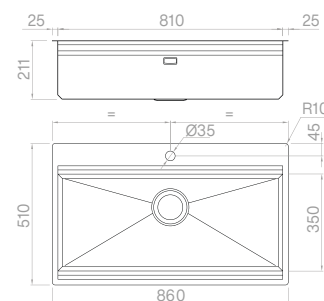

Accessori



Vedi pag. 75 per tutti gli accessori dedicati.

Foro miscelatore:
specificare fori extra
in fase di ordine.

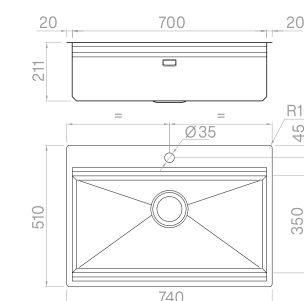

Accessori



Vedi pag. 75 per tutti gli accessori dedicati.

LAYER BRP 65 **READY**



Tagliere in legno
Vaschetta forata
Miscelatore Vertigo

5
22
47

Soprato Cod. **SA BRP 65** € 1.982,00

LAYER BRP 50 **READY**



Tagliere in legno
Vaschetta forata
Miscelatore Vertigo

5
22
47

Soprato Cod. **SA BRP 50** € 1.924,00

LAYER BRP 65 **PRO**



Tagliere in legno

5

Soprato Cod. **SB BRP 65** € 995,00

LAYER BRP 50 **PRO**



Tagliere in legno

5

Soprato Cod. **SB BRP 50** € 937,00

LAYER BRP 65 **SOLO**



Materiale	AISI 304
Finitura	Spazzolato
Raggio interno	Raggio '0'
Misure esterne	690 × 510 mm
Misure vasca	650 × 350 mm
Profondità vasca	210 mm
Piletta Plus	Ø 3 ½"
Base	750 mm

Soprato Cod. **AL BRP 65** € 854,00

LAYER BRP 50 **SOLO**



Materiale	AISI 304
Finitura	Spazzolato
Raggio interno	Raggio '0'
Misure esterne	540 × 510 mm
Misure vasca	500 × 350 mm
Profondità vasca	210 mm
Piletta Plus	Ø 3 ½"
Base	600 mm

Soprato Cod. **AL BRP 50** € 796,00

Foro miscelatore:
specificare fori extra
in fase di ordine.

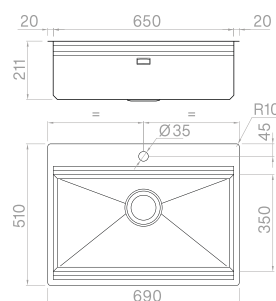

Accessori



Vedi pag. 75 per tutti gli accessori dedicati.

Foro miscelatore:
specificare fori extra
in fase di ordine.

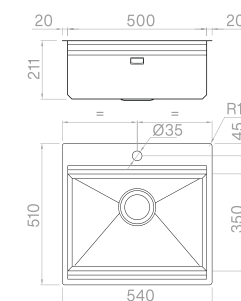

Accessori



Vedi pag. 75 per tutti gli accessori dedicati.

LAYER SP



Il design esclusivo di Layer SP è definito da linee pure caratterizzate da un funzionale sportello sul fondo che cela lo scarico al suo interno.

LAYER SP 81 **READY**



- Tagliere in legno
- Vaschetta forata
- Griglia
- Miscelatore Hero

- 5
- 49
- 15
- 39



Cod. **SA BR81 SP** € 2.433,00

LAYER SP 81 **PRO**



- Tagliere in legno
- Vaschetta forata

- 5
- 49



Cod. **SB BR81 SP** € 1.612,00

LAYER SP 81 **SOLO**

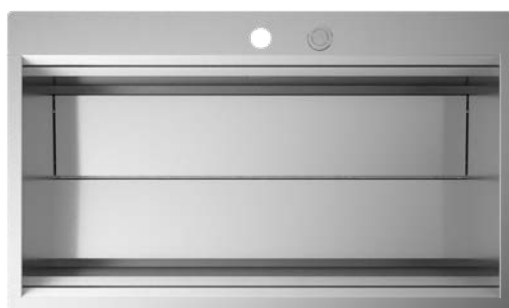

- | | |
|------------------|--------------|
| Materiale | AISI 304 |
| Finitura | Spazzolato |
| Raggio interno | Raggio '0' |
| Misure esterne | 860 × 510 mm |
| Misure vasca | 810 × 350 mm |
| Profondità vasca | 210 mm |
| Piletta Standard | Ø 3 ½" |
| Salterello | Incluso |
| Base | 900 mm |



Cod. **AL BR81 SP** € 1.131,00

Foro miscelatore:
specificare fori extra
in fase di ordine.

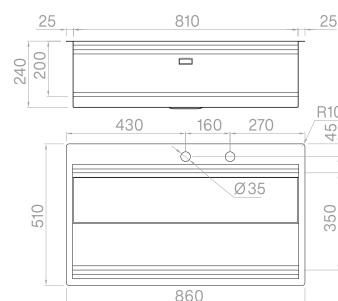

Accessori



Vedi pag. 75 per tutti gli accessori dedicati.

LAYER SP 70 **READY**



- Tagliere in legno
- Vaschetta forata
- Griglia
- Miscelatore Hero

- 5
- 22
- 15
- 39



Cod. **SA BR70 SP** € 2.360,00

LAYER SP 70 **PRO**



- Tagliere in legno
- Vaschetta forata

- 5
- 22



Cod. **SB BR70 SP** € 1.539,00

LAYER SP 70 **SOLO**



- | | |
|------------------|--------------|
| Materiale | AISI 304 |
| Finitura | Spazzolato |
| Raggio interno | Raggio '0' |
| Misure esterne | 740 × 510 mm |
| Misure vasca | 700 × 350 mm |
| Profondità vasca | 210 mm |
| Piletta Standard | Ø 3 ½" |
| Salterello | Incluso |
| Base | 800 mm |



Cod. **AL BR70 SP** € 1.079,00

Foro miscelatore:
specificare fori extra
in fase di ordine.

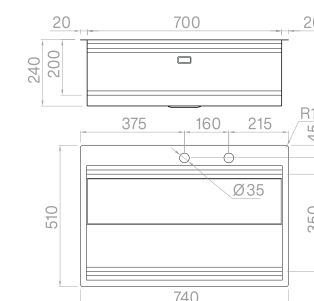

Accessori



Vedi pag. 75 per tutti gli accessori dedicati.

LAYER SBR

Una workstation icona grazie a taglieri, vassoi e tanti speciali accessori scorrevoli che permettono un'area di lavoro funzionale e personalizzabile in infinite possibilità.



LAYER SBR 104

READY



- Tagliere in legno
- Vaschetta forata
- Griglia
- Miscelatore Element

- 5
- 49
- 15
- 40

- Sopratop
- Sottotop

Cod. **SA SBR 104** € 2.551,00
 Cod. **SA SBR ST1** € 2.355,00

LAYER SBR 104

PRO



- Tagliere in legno
- Vaschetta forata

- 5
- 49

- Sopratop
- Sottotop

Cod. **SB SBR 104** € 1.481,00
 Cod. **SB SBR ST1** € 1.285,00

LAYER SBR 104

SOLO



- Materiale AISI 304
- Finitura Spazzolato
- Raggio interno Raggio '0'
- Misure esterne 1080 x 450 mm
- Misure vasca 1040 x 350 mm
- Profondità vasca 210 mm
- Piletta Plus Ø 3 1/2"
- Base 1200 mm

- Sopratop
- Sottotop

Cod. **SBR 104** € 1.000,00
 Cod. **SBR ST 104** € 804,00

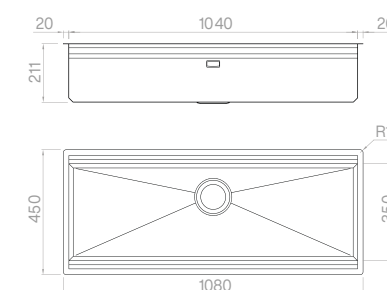

Accessori



Vedi pag. 75 per tutti gli accessori dedicati.

LAYER SBR 81 **READY**



- Tagliere in legno
- Vaschetta forata
- Griglia
- Miscelatore Vertigo

- 5
- 49
- 15
- 47



Cod. **SA SBR 81** € 2.205,00
 Cod. **SA SBR ST8** € 2.062,00

LAYER SBR 70 **READY**



- Tagliere in legno
- Vaschetta forata
- Griglia
- Miscelatore Vertigo

- 5
- 22
- 15
- 47



Cod. **SA SBR 70** € 2.144,00
 Cod. **SA SBR ST7** € 2.003,00

LAYER SBR 81 **PRO**



- Tagliere in legno
- Vaschetta forata

- 5
- 49



Cod. **SB SBR 81** € 1.294,00
 Cod. **SB SBR ST8** € 1.151,00

LAYER SBR 70 **PRO**



- Tagliere in legno
- Vaschetta forata

- 5
- 22



Cod. **SB SBR 70** € 1.233,00
 Cod. **SB SBR ST7** € 1.092,00

LAYER SBR 81 **SOLO**



- | | |
|------------------|--------------|
| Materiale | AISI 304 |
| Finitura | Spazzolato |
| Raggio interno | Raggio '0' |
| Misure esterne | 850 × 450 mm |
| Misure vasca | 810 × 350 mm |
| Profondità vasca | 210 mm |
| Piletta Plus | Ø 3 1/2" |
| Base | 900 mm |



Cod. **SBR 81** € 813,00
 Cod. **SBR ST 81** € 670,00

LAYER SBR 70 **SOLO**



- | | |
|------------------|--------------|
| Materiale | AISI 304 |
| Finitura | Spazzolato |
| Raggio interno | Raggio '0' |
| Misure esterne | 740 × 450 mm |
| Misure vasca | 700 × 350 mm |
| Profondità vasca | 210 mm |
| Piletta Plus | Ø 3 1/2" |
| Base | 800 mm |



Cod. **SBR 70** € 773,00
 Cod. **SBR ST 70** € 632,00

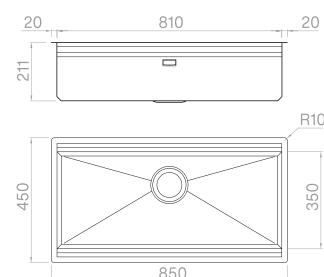

Accessori



Vedi pag. 75 per tutti gli accessori dedicati.

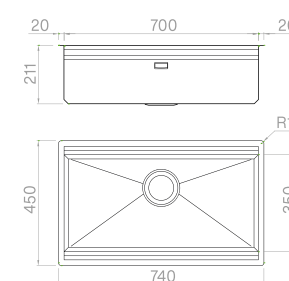

Accessori



Vedi pag. 75 per tutti gli accessori dedicati.

LAYER SBR 65 **READY**



Tagliere in legno
Vaschetta forata
Miscelatore Vertigo

5
22
47



Cod. **SA SBR 65** € 1.844,00
Cod. **SA SBR ST6** € 1.714,00

LAYER SBR 65 **PRO**



Tagliere in legno

5



Cod. **SB SBR 65** € 857,00
Cod. **SB SBR ST6** € 727,00

LAYER SBR 65 **SOLO**



Materiale	AISI 304
Finitura	Spazzolato
Raggio interno	Raggio '0'
Misure esterne	690 × 450 mm
Misure vasca	650 × 350 mm
Profondità vasca	210 mm
Piletta Plus	Ø 3 ½"
Base	750 mm



Cod. **SBR 65** € 716,00
Cod. **SBR ST 65** € 586,00

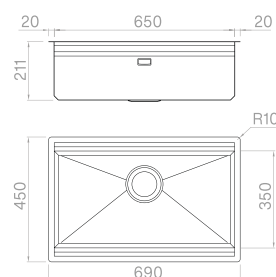

Accessori



Vedi pag. 75 per tutti gli accessori dedicati.

LAYER SBR 50 **READY**



Tagliere in legno
Vaschetta forata
Miscelatore Vertigo

5
22
47



Cod. **SA SBR 50** € 1.788,00
Cod. **SA SBR ST5** € 1.668,00

LAYER SBR 50 **PRO**



Tagliere in legno

5



Cod. **SB SBR 50** € 801,00
Cod. **SB SBR ST5** € 681,00

LAYER SBR 50 **SOLO**



Materiale	AISI 304
Finitura	Spazzolato
Raggio interno	Raggio '0'
Misure esterne	540 × 450 mm
Misure vasca	500 × 350 mm
Profondità vasca	210 mm
Piletta Plus	Ø 3 ½"
Base	600 mm



Cod. **SBR 50** € 660,00
Cod. **SBR ST 50** € 540,00

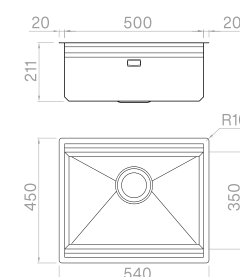

Accessori



Vedi pag. 75 per tutti gli accessori dedicati.

Tagliere in legno**5**

300×405×25 mm

Cod. **TSBR 4030**

€ 141,00

**Griglia****15**

300×405×25 mm

Cod. **GFL 4030**

€ 243,00

**Vaschetta forata****22**

190×375×80 mm

Cod. **VFP SBR19**

€ 319,00

**Vaschetta****29**

300×375×160 mm

Cod. **VGS BR34**

€ 352,00

**Set tagliere + gastronorm****31**

300×405×100 mm

Cod. **TPLB 3V**

€ 421,20

**Set tagliere + colapasta****33**

300×405×100 mm

Cod. **TPLB 1S**

€ 371,00

**Set tagliere + telaio porta coltelli****35**

300×405×20 mm

Cod. **TPLB 4030**

€ 328,00

**Porta piatti****37**

250×400×55 mm

Cod. **PPPB SBR**

€ 182,00

**Vaschetta forata****49**

300×375×80 mm

Cod. **VFG SBR34**

€ 340,00



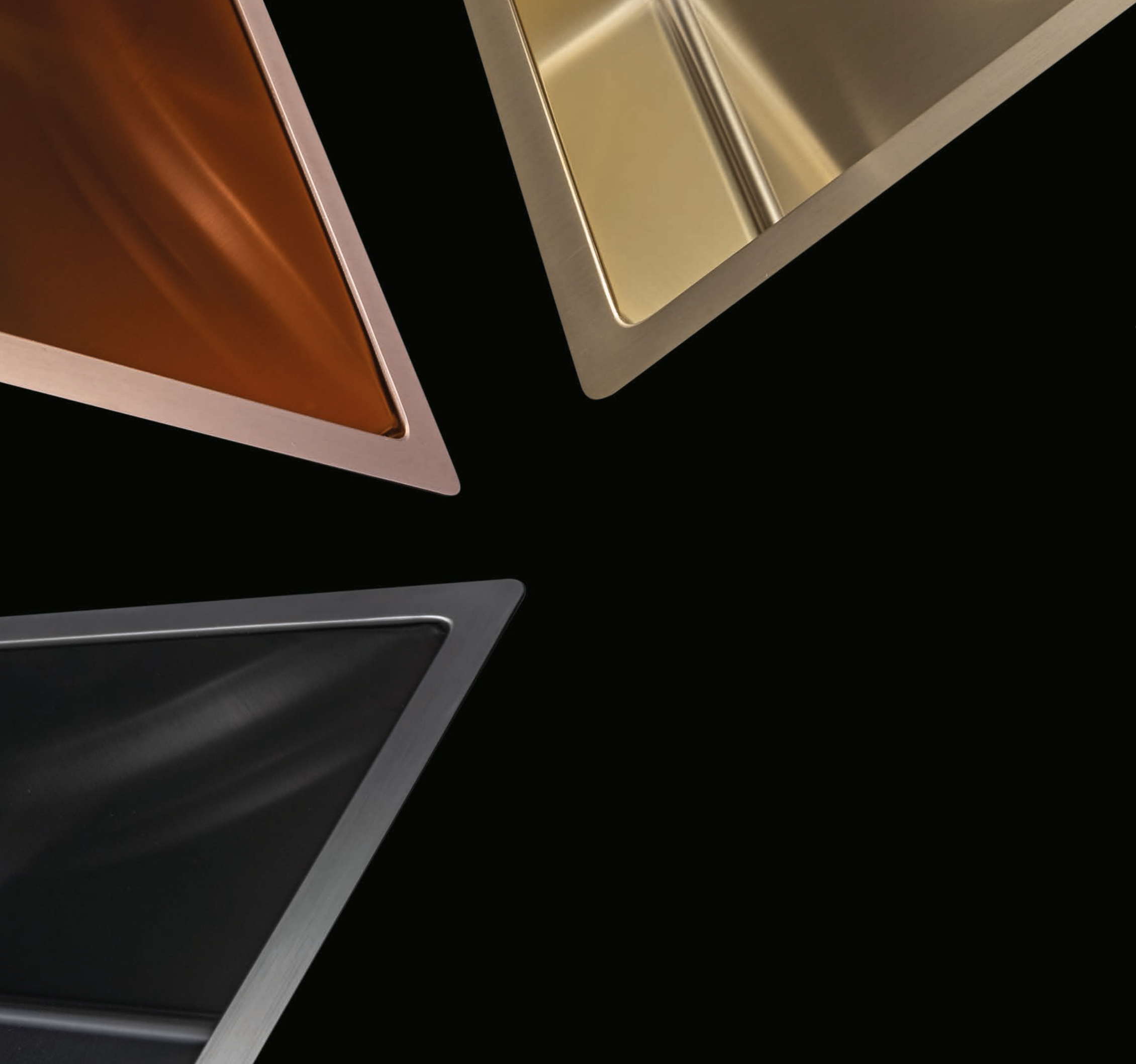

TITANIUM

Lo speciale trattamento PVD è una tecnologia atossica e resistente che permette di virare il colore dell'acciaio inox.

Le tre finiture esclusive Artinox – Gun Metal, Copper Bronze e Pale Gold – sono applicate su lavelli, miscelatori e accessori, offrendo soluzioni monocromatiche dall'altissimo impatto estetico.

TITANIUM GUN METAL





TITANIUM 70 GUN METAL

READY

Vaschetta forata Gun Metal
Miscelatore Athom

17
42



	Sopratop	Cod. SAT I 70 RA	€ 2.245,00
	Filotop	Cod. SATG 70 RA	€ 2.245,00
	Sottotop	Cod. SATO 70 RA	€ 2.165,00



TITANIUM 70 GUN METAL

PRO

Vaschetta forata Gun Metal

17





	Sopratop	Cod. SBT I 70 RA	€ 1.613,00
	Filotop	Cod. SBTG 70 RA	€ 1.613,00
	Sottotop	Cod. SBTO 70 RA	€ 1.533,00

TITANIUM 70 GUN METAL

SOLO



Materiale	AISI 304		
Finitura	PVD Gun Metal		
Raggio interno	Saldato 10 mm		
Misure esterne	740 × 440 mm		
Misure vasca	700 × 400 mm		
Profondità vasca	200 mm		
Piletta Plus Gun Metal	Ø 3 1/2"		
Base	800 mm		
	Sopratop	Cod. TI 7040 RA	€ 1.260,00
	Filotop	Cod. TG 7040 RA	€ 1.260,00
	Sottotop	Cod. TO 7040 RA	€ 1.180,00

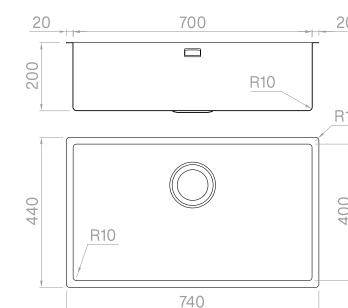

Accessori



Vedi pag. 91 per tutti gli accessori dedicati.

TITANIUM 50 GUN METAL

READY



Vaschetta forata Gun Metal
Miscelatore Athom

17
42

	Sopratop	Cod. SAT I 50 RA	€ 1.928,00
	Filotop	Cod. SATG 50 RA	€ 1.928,00
	Sottotop	Cod. SATO 50 RA	€ 1.864,00

TITANIUM 40 GUN METAL

READY



Vaschetta forata Gun Metal
Miscelatore Athom

17
42

	Sopratop	Cod. SAT I 40 RA	€ 1.869,00
	Filotop	Cod. SATG 40 RA	€ 1.869,00
	Sottotop	Cod. SATO 40 RA	€ 1.794,00

TITANIUM 50 GUN METAL

PRO



Vaschetta forata Gun Metal

17

	Sopratop	Cod. SBT I 50 RA	€ 1.296,00
	Filotop	Cod. SBTG 50 RA	€ 1.296,00
	Sottotop	Cod. SBTO 50 RA	€ 1.232,00

TITANIUM 40 GUN METAL

PRO



Vaschetta forata Gun Metal

17

	Sopratop	Cod. SBT I 40 RA	€ 1.237,00
	Filotop	Cod. SBTG 40 RA	€ 1.237,00
	Sottotop	Cod. SBTO 40 RA	€ 1.162,00

TITANIUM 50 GUN METAL

SOLO



Materiale	AISI 304		
Finitura	PVD Gun Metal		
Raggio interno	Saldato 10 mm		
Misure esterne	540 × 440 mm		
Misure vasca	500 × 400 mm		
Profondità vasca	200 mm		
Piletta Plus Gun Metal	Ø 3 1/2"		
Base	600 mm		
	Sopratop	Cod. TI 5040 RA	€ 943,00
	Filotop	Cod. TG 5040 RA	€ 943,00
	Sottotop	Cod. TO 5040 RA	€ 879,00

TITANIUM 40 GUN METAL

SOLO



Materiale	AISI 304		
Finitura	PVD Gun Metal		
Raggio interno	Saldato 10 mm		
Misure esterne	440 × 440 mm		
Misure vasca	400 × 400 mm		
Profondità vasca	200 mm		
Piletta Plus Gun Metal	Ø 3 1/2"		
Base	600 mm		
	Sopratop	Cod. TI 4040 RA	€ 884,00
	Filotop	Cod. TG 4040 RA	€ 884,00
	Sottotop	Cod. TO 4040 RA	€ 809,00

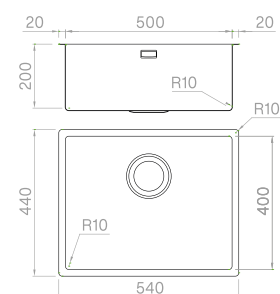

Accessori



Vedi pag. 91 per tutti gli accessori dedicati.

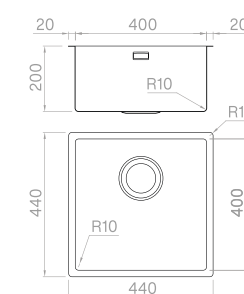

Accessori



Vedi pag. 91 per tutti gli accessori dedicati.

TITANIUM COPPER BRONZE



TITANIUM 70 COPPER BRONZE

READY

Vaschetta forata Copper Bronze

18

Miscelatore Athom

43

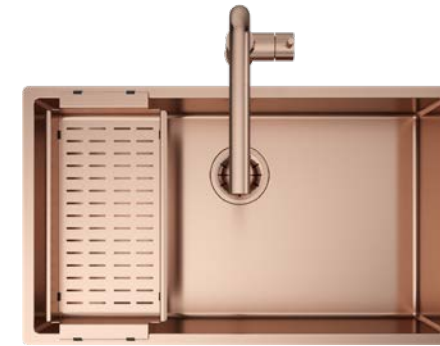

Sopratop	Cod. SAT I 70 RC	€ 2.245,00
Filotop	Cod. SATG 70 RC	€ 2.245,00
Sottotop	Cod. SATO 70 RC	€ 2.165,00

TITANIUM 70 COPPER BRONZE

PRO

Vaschetta forata Copper Bronze

18



Sopratop	Cod. SBT I 70 RC	€ 1.613,00
Filotop	Cod. SBTG 70 RC	€ 1.613,00
Sottotop	Cod. SBTO 70 RC	€ 1.533,00

TITANIUM 70 COPPER BRONZE

SOLO



Materiale	AISI 304
Finitura	PVD Copper Bronze
Raggio interno	Saldato 10 mm
Misure esterne	740 × 440 mm
Misure vasca	700 × 400 mm
Profondità vasca	200 mm
Piletta Plus Copper Bronze	Ø 3 1/2"
Base	800 mm

Sopratop	Cod. TI 7040 RC	€ 1.260,00
Filotop	Cod. TG 7040 RC	€ 1.260,00
Sottotop	Cod. TO 7040 RC	€ 1.180,00

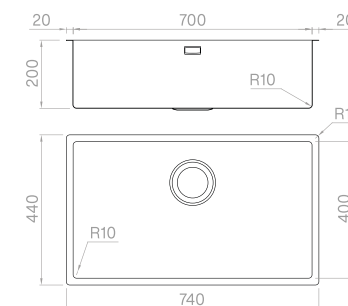

Accessori



Vedi pag. 91 per tutti gli accessori dedicati.



TITANIUM 50 COPPER BRONZE

READY



Vaschetta forata Copper Bronze
Miscelatore Athom

18
43

-  Sopratop Cod. **SAT I 50 RC** € 1.928,00
-  Filotop Cod. **SATG 50 RC** € 1.928,00
-  Sottotop Cod. **SATO 50 RC** € 1.864,00



TITANIUM 50 COPPER BRONZE

PRO



Vaschetta forata Copper Bronze



18

-  Sopratop Cod. **SBT I 50 RC** € 1.296,00
-  Filotop Cod. **SBTG 50 RC** € 1.296,00
-  Sottotop Cod. **SBTO 50 RC** € 1.232,00

TITANIUM 50 COPPER BRONZE

SOLO



- | | |
|----------------------------|-------------------|
| Materiale | AISI 304 |
| Finitura | PVD Copper Bronze |
| Raggio interno | Saldato 10 mm |
| Misure esterne | 540 × 440 mm |
| Misure vasca | 500 × 400 mm |
| Profondità vasca | 200 mm |
| Piletta Plus Copper Bronze | Ø 3 ½" |
| Base | 600 mm |
-  Sopratop Cod. **TI 5040 RC** € 943,00
 -  Filotop Cod. **TG 5040 RC** € 943,00
 -  Sottotop Cod. **TO 5040 RC** € 879,00

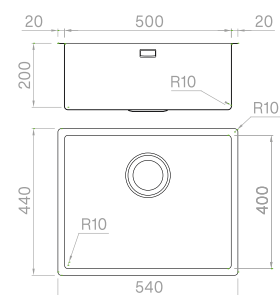

Accessori



Vedi pag. 91 per tutti gli accessori dedicati.



TITANIUM 40 COPPER BRONZE

READY



Vaschetta forata Copper Bronze
Miscelatore Athom

18
43

-  Sopratop Cod. **SAT I 40 RC** € 1.869,00
-  Filotop Cod. **SATG 40 RC** € 1.869,00
-  Sottotop Cod. **SATO 40 RC** € 1.794,00



TITANIUM 40 COPPER BRONZE

PRO



Vaschetta forata Copper Bronze



18

-  Sopratop Cod. **SBT I 40 RC** € 1.237,00
-  Filotop Cod. **SBTG 40 RC** € 1.237,00
-  Sottotop Cod. **SBTO 40 RC** € 1.162,00

TITANIUM 40 COPPER BRONZE

SOLO



- | | |
|----------------------------|-------------------|
| Materiale | AISI 304 |
| Finitura | PVD Copper Bronze |
| Raggio interno | Saldato 10 mm |
| Misure esterne | 440 × 440 mm |
| Misure vasca | 400 × 400 mm |
| Profondità vasca | 200 mm |
| Piletta Plus Copper Bronze | Ø 3 ½" |
| Base | 600 mm |
-  Sopratop Cod. **TI 4040 RC** € 884,00
 -  Filotop Cod. **TG 4040 RC** € 884,00
 -  Sottotop Cod. **TO 4040 RC** € 809,00

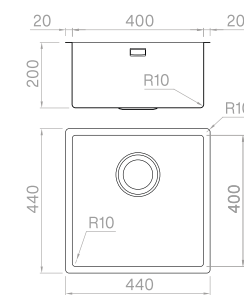

Accessori



Vedi pag. 91 per tutti gli accessori dedicati.

TITANIUM PALE GOLD







TITANIUM 70 PALE GOLD

READY

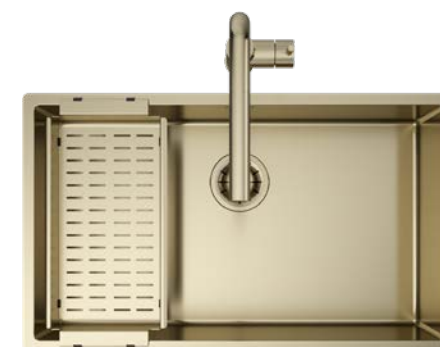
Vaschetta forata Pale Gold
Miscelatore Athom

19
44



 Sopratop	Cod. SAT I 70 RG	€ 2.245,00
 Filotop	Cod. SATG 70 RG	€ 2.245,00
 Sottotop	Cod. SATO 70 RG	€ 2.165,00



TITANIUM 70 PALE GOLD

PRO

Vaschetta forata Pale Gold

19





 Sopratop	Cod. SBT I 70 RG	€ 1.613,00
 Filotop	Cod. SBTG 70 RG	€ 1.613,00
 Sottotop	Cod. SBTO 70 RG	€ 1.533,00

TITANIUM 70 PALE GOLD

SOLO



Materiale	AISI 304	
Finitura	PVD Pale Gold	
Raggio interno	Saldato 10 mm	
Misure esterne	740 × 440 mm	
Misure vasca	700 × 400 mm	
Profondità vasca	200 mm	
Piletta Plus Pale Gold	Ø 3 1/2"	
Base	800 mm	
 Sopratop	Cod. TI 7040 RG	€ 1.260,00
 Filotop	Cod. TG 7040 RG	€ 1.260,00
 Sottotop	Cod. TO 7040 RG	€ 1.180,00

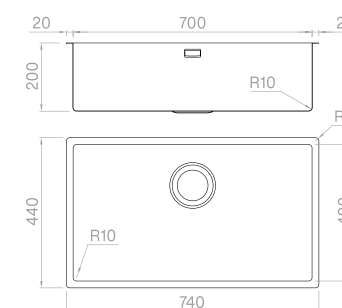

Accessori



Vedi pag. 91 per tutti gli accessori dedicati.

TITANIUM 50 PALE GOLD

READY

Vaschetta forata Pale Gold
Miscelatore Athom

19
44



-  Sopratop Cod. **SAT I 50 RG** € 1.928,00
-  Filotop Cod. **SATG 50 RG** € 1.928,00
-  Sottotop Cod. **SATO 50 RG** € 1.864,00

TITANIUM 50 PALE GOLD

PRO

Vaschetta forata Pale Gold



19



-  Sopratop Cod. **SBT I 50 RG** € 1.296,00
-  Filotop Cod. **SBTG 50 RG** € 1.296,00
-  Sottotop Cod. **SBTO 50 RG** € 1.232,00

TITANIUM 50 PALE GOLD

SOLO

- | | |
|------------------------|---------------|
| Materiale | AISI 304 |
| Finitura | PVD Pale Gold |
| Raggio interno | Saldato 10 mm |
| Misure esterne | 540 × 440 mm |
| Misure vasca | 500 × 400 mm |
| Profondità vasca | 200 mm |
| Piletta Plus Pale Gold | Ø 3 ½" |
| Base | 600 mm |
-  Sopratop Cod. **TI 5040 RG** € 943,00
 -  Filotop Cod. **TG 5040 RG** € 943,00
 -  Sottotop Cod. **TO 5040 RG** € 879,00

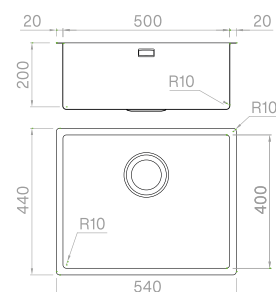

Accessori



Vedi pag. 91 per tutti gli accessori dedicati.

TITANIUM 40 PALE GOLD

READY

Vaschetta forata Pale Gold
Miscelatore Athom

19
44



-  Sopratop Cod. **SAT I 40 RG** € 1.869,00
-  Filotop Cod. **SATG 40 RG** € 1.869,00
-  Sottotop Cod. **SATO 40 RG** € 1.794,00



TITANIUM 40 PALE GOLD

PRO

Vaschetta forata Pale Gold



19



-  Sopratop Cod. **SBT I 40 RG** € 1.237,00
-  Filotop Cod. **SBTG 40 RG** € 1.237,00
-  Sottotop Cod. **SBTO 40 RG** € 1.162,00

TITANIUM 40 PALE GOLD

SOLO

- | | |
|------------------------|---------------|
| Materiale | AISI 304 |
| Finitura | PVD Pale Gold |
| Raggio interno | Saldato 10 mm |
| Misure esterne | 440 × 440 mm |
| Misure vasca | 400 × 400 mm |
| Profondità vasca | 200 mm |
| Piletta Plus Pale Gold | Ø 3 ½" |
| Base | 600 mm |
-  Sopratop Cod. **TI 4040 RG** € 884,00
 -  Filotop Cod. **TG 4040 RG** € 884,00
 -  Sottotop Cod. **TO 4040 RG** € 809,00

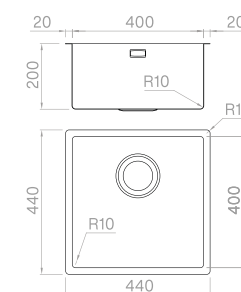

Accessori



Vedi pag. 91 per tutti gli accessori dedicati.

**Tagliere in legno****3**300×420×20 mm
Cod. **TRIB 3042**

€ 137,00

**Tagliere in HDPE****6**240×427×20 mm
Cod. **TRP 2442**

€ 149,00

**Vaschetta forata Gun Metal****17**210×420×60 mm
Cod. **VQAF 2142**

€ 353,00

**Vaschetta forata Copper Bronze****18**210×420×60 mm
Cod. **VQCF 2142**

€ 353,00

**Vaschetta forata Pale Gold****19**210×420×60 mm
Cod. **VQGF 2142**

€ 353,00

**Set gastronorm****30**240×420×100 mm
Cod. **TI 2442 V**

€ 221,50

**Set scolapasta****32**240×420×100 mm
Cod. **TI 2442 1S**

€ 170,00

**Set grattugie****34**240×420×28 mm
Cod. **TI 2442 PG**

€ 351,00



RADIUS



RADIUS MATTE VINTAGE

Un lavello elegante e sofisticato grazie all'abbinamento fra l'acciaio Matte Vintage e la finitura nera dei miscelatori e degli accessori.

Il Matte Vintage è un'esclusiva Artinox caratterizzata da una superficie non uniforme che esalta la matericità dell'acciaio inossidabile.



RADIUS MATTE VINTAGE 70

READY

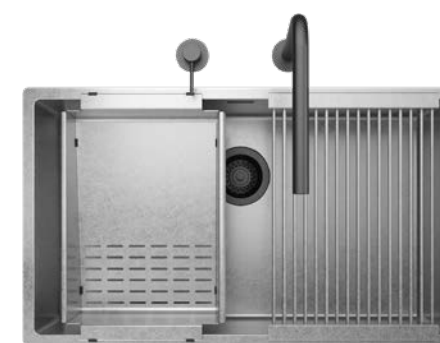

Griglia
Vaschetta inclinata forata
Miscelatore Ergo

13
24
41

	Sopratop	Cod. SAB I 70 RH	€ 2.006,00
	Filotop	Cod. SABG 70 RH	€ 2.006,00
	Sottotop	Cod. SABO 70 RH	€ 1.909,00

RADIUS MATTE VINTAGE 70

PRO



Vaschetta inclinata forata

24

	Sopratop	Cod. SBB I 70 RH	€ 1.087,00
	Filotop	Cod. SBBG 70 RH	€ 1.087,00
	Sottotop	Cod. SBBO 70 RH	€ 990,00

RADIUS MATTE VINTAGE 70

SOLO



Materiale	AISI 304		
Finitura	Spazzolato opaco		
Raggio interno	Saldato 10 mm		
Misure esterne	740 × 440 mm		
Misure vasca	700 × 400 mm		
Profondità vasca	200 mm		
Piletta Nera	Ø 3 1/2"		
Base	800 mm		
	Sopratop	Cod. BI 7040 RH	€ 809,00
	Filotop	Cod. BG 7040 RH	€ 809,00
	Sottotop	Cod. BO 7040 RH	€ 712,00

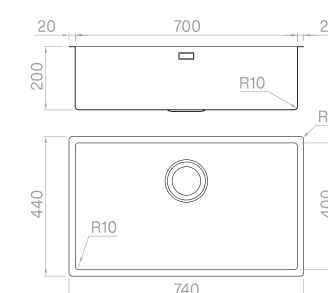

Accessori



Vedi pag. 99 per tutti gli accessori dedicati.

RADIUS MATTE VINTAGE 50

READY

Vaschetta inclinata forata
Miscelatore Ergo

24
41



	Sopratop	Cod. SAB I 50 RH	€ 1.564,00
	Filotop	Cod. SABG 50 RH	€ 1.564,00
	Sottotop	Cod. SABO 50 RH	€ 1.488,00

RADIUS MATTE VINTAGE 50

PRO

Vaschetta inclinata forata

24



	Sopratop	Cod. SBB I 50 RH	€ 945,00
	Filotop	Cod. SBBG 50 RH	€ 945,00
	Sottotop	Cod. SBBO 50 RH	€ 869,00

RADIUS MATTE VINTAGE 50

SOLO

Materiale	AISI 304		
Finitura	Spazzolato opaco		
Raggio interno	Saldato 10 mm		
Misure esterne	540 × 440 mm		
Misure vasca	500 × 400 mm		
Profondità vasca	200 mm		
Piletta Nera	Ø 3 ½"		
Base	600 mm		
	Sopratop	Cod. BI 5040 RH	€ 667,00
	Filotop	Cod. BG 5040 RH	€ 667,00
	Sottotop	Cod. BO 5040 RH	€ 591,00

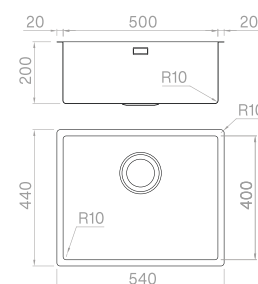

Accessori

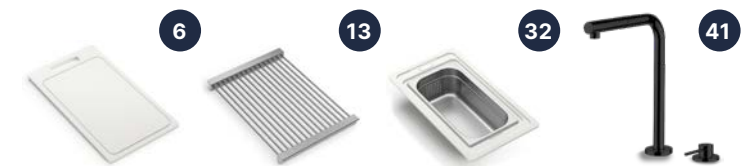

Vedi pag. 99 per tutti gli accessori dedicati.

RADIUS MATTE VINTAGE 40

READY

Vaschetta inclinata forata
Miscelatore Ergo

24
41



	Sopratop	Cod. SAB I 40 RH	€ 1.540,00
	Filotop	Cod. SABG 40 RH	€ 1.540,00
	Sottotop	Cod. SABO 40 RH	€ 1.446,00

RADIUS MATTE VINTAGE 40

PRO

Vaschetta inclinata forata

24



	Sopratop	Cod. SBB I 40 RH	€ 921,00
	Filotop	Cod. SBBG 40 RH	€ 921,00
	Sottotop	Cod. SBBO 40 RH	€ 827,00

RADIUS MATTE VINTAGE 40

SOLO

Materiale	AISI 304		
Finitura	Spazzolato opaco		
Raggio interno	Saldato 10 mm		
Misure esterne	440 × 440 mm		
Misure vasca	400 × 400 mm		
Profondità vasca	200 mm		
Piletta Nera	Ø 3 ½"		
Base	600 mm		
	Sopratop	Cod. BI 4040 RH	€ 643,00
	Filotop	Cod. BG 4040 RH	€ 643,00
	Sottotop	Cod. BO 4040 RH	€ 549,00

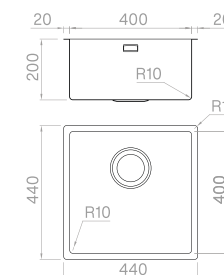

Accessori

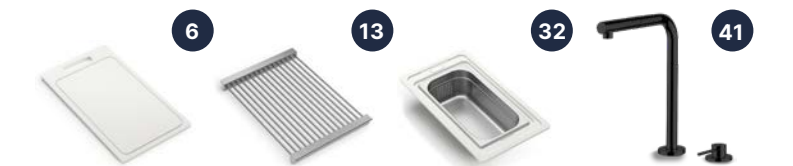

Vedi pag. 99 per tutti gli accessori dedicati.

Tagliere in legno**3**

300×420×20 mm

Cod. **TRIB 3042**

€ 137,00

**Tagliere in HDPE****6**

240×427×20 mm

Cod. **TRP 2442**

€ 149,00

**Griglia matte vintage****13**

250×420×25 mm

Cod. **GRH 2542**

€ 300,00

**Vaschetta inclinata forata matte vintage****24**

280×420×110/60 mm

Cod. **VQHI 2842**

€ 278,00

**Set gastronorm****30**

240×420×100 mm

Cod. **TI 2442 V**

€ 221,50

**Set scolapasta****32**

240×420×100 mm

Cod. **TI 2442 1S**

€ 170,00

**Set grattugie****34**

240×420×28 mm

Cod. **TI 2442 PG**

€ 351,00



RADIUS

La collezione Radius ha un'ampia scelta di lavelli, realizzati con angoli interni raggio 10 mm. La precisione si somma all'essenzialità delle geometrie.



RADIUS 81

READY



Tagliere in legno
Vaschetta inclinata forata
Vaschetta
Miscelatore Element

3
23
26
40

	Sopratop	Cod. SAB I 81 R1	€ 2.229,00
	Filotop	Cod. SABG 81 R1	€ 2.229,00
	Sottotop	Cod. SABO 81 R1	€ 2.159,00

RADIUS 81

PRO



Vaschetta forata

16

	Sopratop	Cod. SBB I 81 R1	€ 953,00
	Filotop	Cod. SBBG 81 R1	€ 953,00
	Sottotop	Cod. SBBO 81 R1	€ 883,00

RADIUS 81

SOLO



Materiale	AISI 304		
Finitura	Spazzolato		
Raggio interno	Saldato 10 mm		
Misure esterne	850 × 440 mm		
Misure vasca	810 × 400 mm		
Profondità vasca	200 mm		
Piletta Standard	Ø 3 1/2"		
Base	900 mm		
	Sopratop	Cod. BI 8140 R1	€ 749,00
	Filotop	Cod. BG 8140 R1	€ 749,00
	Sottotop	Cod. BO 8140 R1	€ 679,00

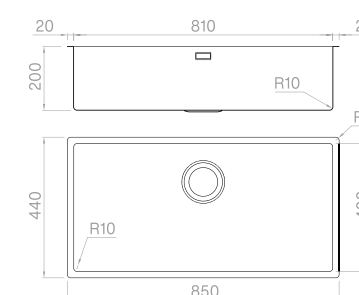

Accessori

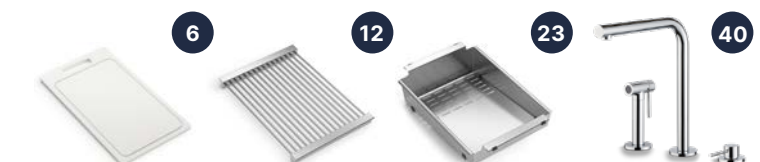

Vedi pag. 109 per tutti gli accessori dedicati.

RADIUS 70

READY



- Tagliere in legno
- Vaschetta inclinata forata
- Vaschetta
- Miscelatore Element

- 3
- 23
- 26
- 40

	Sopratop	Cod. SAB I 70 R1	€ 2.153,00
	Filotop	Cod. SABG 70 R1	€ 2.153,00
	Sottotop	Cod. SABO 70 R1	€ 2.073,00

RADIUS 65

READY



- Tagliere in legno
- Vaschetta inclinata forata
- Miscelatore Hero

- 3
- 23
- 39

	Sopratop	Cod. SAB I 65 R1	€ 1.571,00
	Filotop	Cod. SABG 65 R1	€ 1.571,00
	Sottotop	Cod. SABO 65 R1	€ 1.498,00

RADIUS 70

PRO



- Vaschetta forata

- 16

	Sopratop	Cod. SBB I 70 R1	€ 877,00
	Filotop	Cod. SBBG 70 R1	€ 877,00
	Sottotop	Cod. SBBO 70 R1	€ 797,00

RADIUS 65

PRO



- Vaschetta forata

- 16

	Sopratop	Cod. SBB I 65 R1	€ 818,00
	Filotop	Cod. SBBG 65 R1	€ 818,00
	Sottotop	Cod. SBBO 65 R1	€ 745,00

RADIUS 70

SOLO



Materiale	AISI 304		
Finitura	Spazzolato		
Raggio interno	Saldato 10 mm		
Misure esterne	740 × 440 mm		
Misure vasca	700 × 400 mm		
Profondità vasca	200 mm		
Piletta Standard	Ø 3 1/2"		
Base	800 mm		
	Sopratop	Cod. BI 7040 R1	€ 673,00
	Filotop	Cod. BG 7040 R1	€ 673,00
	Sottotop	Cod. BO 7040 R1	€ 593,00

RADIUS 65

SOLO



Materiale	AISI 304		
Finitura	Spazzolato		
Raggio interno	Saldato 10 mm		
Misure esterne	690 × 440 mm		
Misure vasca	650 × 400 mm		
Profondità vasca	200 mm		
Piletta Standard	Ø 3 1/2"		
Base	750 mm		
	Sopratop	Cod. BI 6540 R1	€ 614,00
	Filotop	Cod. BG 6540 R1	€ 614,00
	Sottotop	Cod. BO 6540 R1	€ 541,00

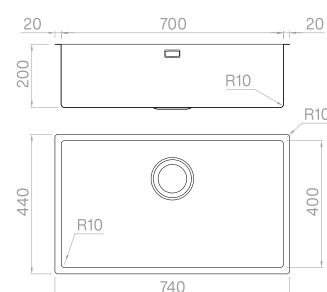

Accessori

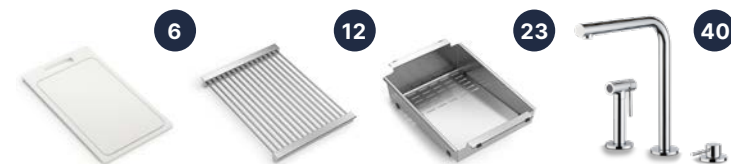

Vedi pag. 109 per tutti gli accessori dedicati.

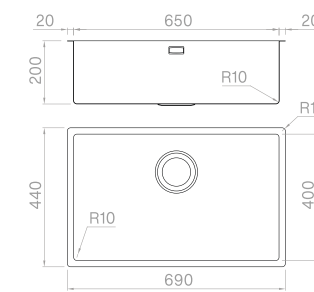

Accessori

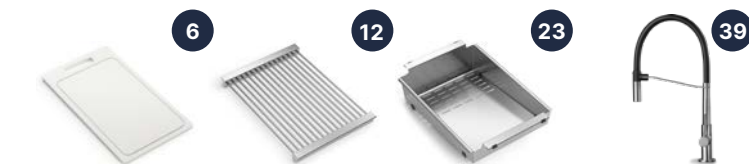

Vedi pag. 109 per tutti gli accessori dedicati.



RADIUS 50

READY



Tagliere in legno
Vaschetta inclinata forata
Miscelatore Hero

3
23
39

 Sopratop Cod. **SAB I 50 R1** € 1.513,00
 Filotop Cod. **SABG 50 R1** € 1.513,00
 Sottotop Cod. **SABO 50 R1** € 1.449,00

RADIUS 50

PRO



Vaschetta forata

16



 Sopratop Cod. **SBB I 50 R1** € 760,00
 Filotop Cod. **SBBG 50 R1** € 760,00
 Sottotop Cod. **SBBO 50 R1** € 696,00

RADIUS 50

SOLO



Materiale	AISI 304
Finitura	Spazzolato
Raggio interno	Saldato 10 mm
Misure esterne	540 × 440 mm
Misure vasca	500 × 400 mm
Profondità vasca	200 mm
Piletta Standard	Ø 3 ½"
Base	600 mm

 Sopratop Cod. **BI 5040 R1** € 556,00
 Filotop Cod. **BG 5040 R1** € 556,00
 Sottotop Cod. **BO 5040 R1** € 492,00

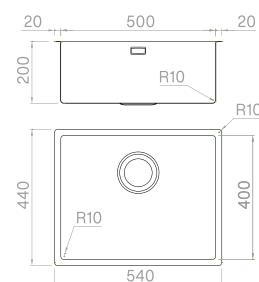

Accessori

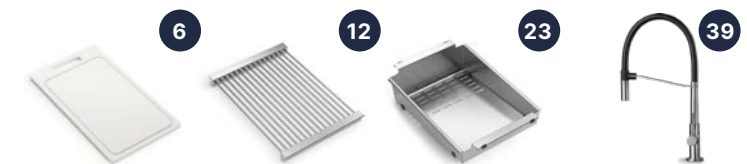

Vedi pag. 109 per tutti gli accessori dedicati.

RADIUS 45

READY

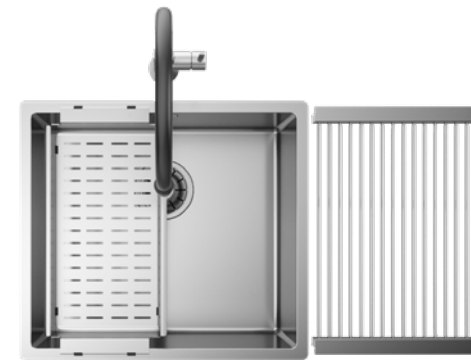

Griglia
Vaschetta forata
Miscelatore Hero

12
16
39

 Sopratop Cod. **SAB I 45 R1** € 1.697,00
 Filotop Cod. **SABG 45 R1** € 1.697,00
 Sottotop Cod. **SABO 45 R1** € 1.607,00



RADIUS 45

PRO



Vaschetta forata

16



 Sopratop Cod. **SBB I 45 R1** € 859,00
 Filotop Cod. **SBBG 45 R1** € 859,00
 Sottotop Cod. **SBBO 45 R1** € 769,00

RADIUS 45

SOLO



Materiale	AISI 304
Finitura	Spazzolato
Raggio interno	Saldato 10 mm
Misure esterne	490 × 440 mm
Misure vasca	450 × 400 mm
Profondità vasca	200 mm
Piletta Standard	Ø 3 ½"
Base	600 mm

 Sopratop Cod. **BI 4540 R1** € 655,00
 Filotop Cod. **BG 4540 R1** € 655,00
 Sottotop Cod. **BO 4540 R1** € 565,00

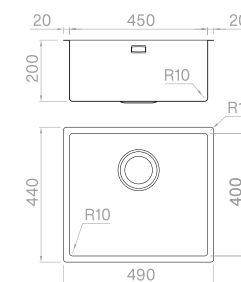

Accessori



Vedi pag. 109 per tutti gli accessori dedicati.

RADIUS 40 + 34

READY

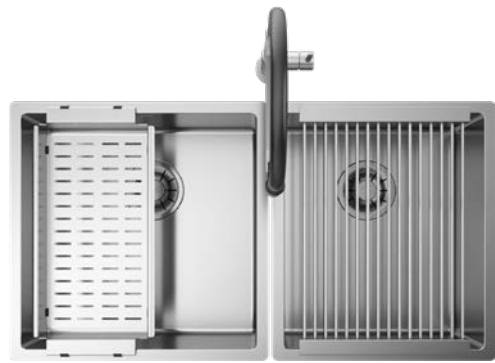

Griglia
Vaschetta forata
Miscelatore Hero

12
16
39

	Sopratop	Cod. SAB I 40 R1	€ 1.578,00
	Filotop	Cod. SABG 40 R1	€ 1.578,00
	Sottotop	Cod. SABO 40 R1	€ 1.499,00

RADIUS 34+34

READY

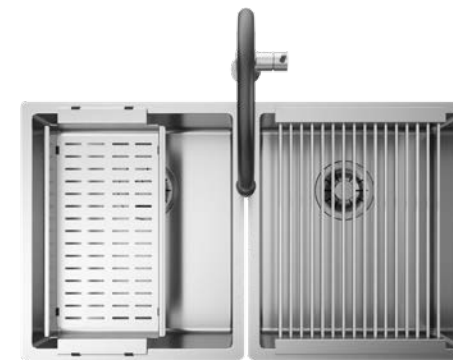

Griglia
Vaschetta forata
Miscelatore Hero

12
16
39

	Sopratop	Cod. SAB I 34 R1	€ 1.556,00
	Filotop	Cod. SABG 34 R1	€ 1.556,00
	Sottotop	Cod. SABO 34 R1	€ 1.477,00

RADIUS 40

PRO



Vaschetta forata

16

	Sopratop	Cod. SBB I 40 R1	€ 740,00
	Filotop	Cod. SBBG 40 R1	€ 740,00
	Sottotop	Cod. SBBO 40 R1	€ 661,00

RADIUS 34

PRO



Vaschetta forata

16

	Sopratop	Cod. SBB I 34 R1	€ 718,00
	Filotop	Cod. SBBG 34 R1	€ 718,00
	Sottotop	Cod. SBBO 34 R1	€ 639,00

RADIUS 40

SOLO



Materiale	AISI 304		
Finitura	Spazzolato		
Raggio interno	Saldato 10 mm		
Misure esterne	440 × 440 mm		
Misure vasca	400 × 400 mm		
Profondità vasca	200 mm		
Piletta Standard	Ø 3 ½"		
Base	600 mm		
	Sopratop	Cod. BI 4040 R1	€ 536,00
	Filotop	Cod. BG 4040 R1	€ 536,00
	Sottotop	Cod. BO 4040 R1	€ 457,00

RADIUS 34

SOLO



Materiale	AISI 304		
Finitura	Spazzolato		
Raggio interno	Saldato 10 mm		
Misure esterne	380 × 440 mm		
Misure vasca	340 × 400 mm		
Profondità vasca	200 mm		
Piletta Standard	Ø 3 ½"		
Base	600 mm		
	Sopratop	Cod. BI 3440 R1	€ 514,00
	Filotop	Cod. BG 3440 R1	€ 514,00
	Sottotop	Cod. BO 3440 R1	€ 435,00

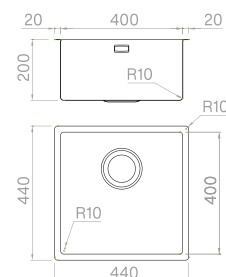

Accessori



Vedi pag. 109 per tutti gli accessori dedicati.

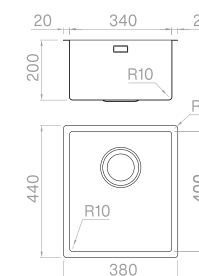

Accessori

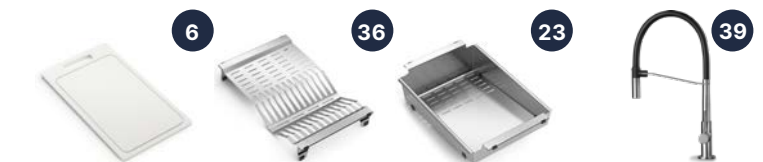

Vedi pag. 109 per tutti gli accessori dedicati.

**Tagliere in legno****3**

300×420×20 mm

Cod. **TRIB 3042**

€ 137,00

**Tagliere in HDPE****6**

240×427×20 mm

Cod. **TRP 2442**

€ 149,00

**Griglia****12**

250×420×25 mm

Cod. **GRS 2542**

€ 260,00

**Vaschetta forata****16**

210×420×60 mm

Cod. **VQSF 2142**

€ 204,00

**Vaschetta inclinata forata****23**

280×420×110/60 mm

Cod. **VQSI 2842**

€ 242,00

**Vaschetta****26**

280×420×160 mm

Cod. **VQSP 2842**

€ 274,00

**Set gastronorm****30**

240×420×100 mm

Cod. **TI 2442 V**

€ 221,50

**Set scolapasta****32**

240×420×100 mm

Cod. **TI 2442 1S**

€ 170,00

**Set grattugie****34**

240×420×28 mm

Cod. **TI 2442 PG**

€ 351,00

**Portapiatti****36**

250×420×55 mm

Cod. **PPPB V400**

€ 182,00



GHOST

Ghost ha un ribassamento nella parete posteriore che consente l'alloggiamento del miscelatore all'interno dell'area operativa: una soluzione brillante in uno spazio contenuto e di qualità premium.



GHOST 60

READY



Cola pasta - set
Tagliere in HDPE
Miscelatore Circle

32
6
45

	Sopratop	Cod. SAG I 60 RM	€ 1.885,00
	Filotop	Cod. SAGF 60 RM	€ 1.885,00
	Sottotop	Cod. SAGO 60 RM	€ 1.817,00

GHOST 60

PRO



Tagliere in HDPE

6

	Sopratop	Cod. SBG I 60 RM	€ 1.075,00
	Filotop	Cod. SBGF 60 RM	€ 1.075,00
	Sottotop	Cod. SBGO 60 RM	€ 1.007,00

GHOST 60

SOLO



Materiale	AISI 304		
Finitura	Spazzolato		
Raggio interno	Saldato 10 mm		
Misure esterne	440 × 520 mm		
Misure vasca	400 × 400 + 80 mm		
Profondità vasca	200 (150 + 50) mm		
Piletta Standard	Ø 3 1/2"		
Base	600 mm		
	Sopratop	Cod. SIG 60 RM	€ 926,00
	Filotop	Cod. SFG 60 RM	€ 926,00
	Sottotop	Cod. SSG 60 RM	€ 858,00

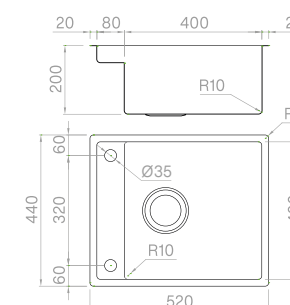

Accessori



Vedi pag. 113 per tutti gli accessori dedicati.

**Tagliere in legno****3**

300×420×20 mm

Cod. **TRIB 3042**

€ 137,00

**Tagliere in HDPE****6**

240×427×20 mm

Cod. **TRP 2442**

€ 149,00

**Griglia****12**

250×420×25 mm

Cod. **GRS 2542**

€ 260,00

**Vaschetta forata****16**

210×420×60 mm

Cod. **VQSF 2142**

€ 204,00

**Set gastronorm****30**

240×420×100 mm

Cod. **TI 2442 V**

€ 221,50

**Set scolapasta****32**

240×420×100 mm

Cod. **TI 2442 1S**

€ 170,00

**Set grattugie****34**

240×420×28 mm

Cod. **TI 2442 PG**

€ 351,00

**Portapiatti****36**

250×420×55 mm

Cod. **PPPB V400**

€ 182,00



MOSE

La collezione Mose è caratterizzata da lavelli a doppia vasca con ponte ribassato, che consente lo scorrimento degli accessori su tutta la lunghezza.

In alcuni modelli, l'alloggiamento del miscelatore è integrato nell'area operativa.



MOSE BR 81 **READY**



Tagliere in legno
Vaschetta forata
Miscelatore Hero

3
16
39

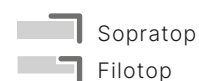

Cod. **SAM BR I 81** € 2.247,00
Cod. **SAM BRG 81** € 2.247,00

MOSE BR 81 **PRO**



Vaschetta forata

16



Cod. **SBM BR I 81** € 1.532,00
Cod. **SBM BRG 81** € 1.532,00

MOSE BR 81 **SOLO**



Materiale AISI 304
Finitura Spazzolato
Raggio interno Saldato 10 mm
Misure esterne 810 × 510 mm
Misure vasca 400 × 400 mm / 340 × 400 mm
Profondità vasca 200 mm
Piletta Standard Ø 3 ½''
Base 900 mm



Cod. **ALM BR I 81** € 1.328,00
Cod. **ALM BRG 81** € 1.328,00

Foro miscelatore:
specificare fori extra
in fase di ordine.

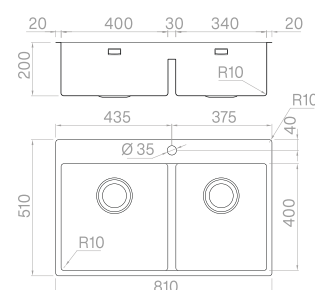

Accessori

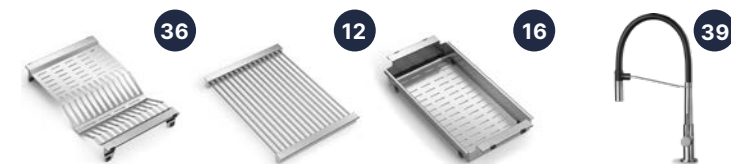

Vedi pag. 121 per tutti gli accessori dedicati.

MOSE BR 60 **READY**



Tagliere in legno
Vaschetta forata
Miscelatore Hero

3
16
39



Cod. **SAM BR I 60** € 2.183,00
Cod. **SAM BRG 60** € 2.183,00

MOSE BR 60 **PRO**



Vaschetta forata

16



Cod. **SBM BR I 60** € 1.468,00
Cod. **SBM BRG 60** € 1.468,00

MOSE BR 60 **SOLO**



Materiale AISI 304
Finitura Spazzolato
Raggio interno Saldato 10 mm
Misure esterne 590 × 510 mm
Misure vasca 180 × 400 mm / 340 × 400 mm
Profondità vasca 170 / 200 mm
Piletta Standard Ø 3 ½''
Base 600 mm



Cod. **ALM BR I 60** € 1.264,00
Cod. **ALM BRG 60** € 1.264,00

Foro miscelatore:
specificare fori extra
in fase di ordine.

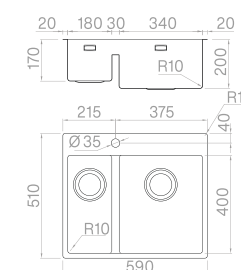

Accessori

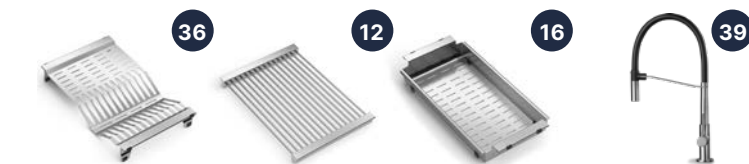

Vedi pag. 121 per tutti gli accessori dedicati.

MOSE SB 81 **READY**



Tagliere in legno
Vaschetta forata
Miscelatore Hero

3
16
39

Sopratop
 Filotop
 Sottotop

Cod. **SAM I 81 R1** € 2.174,00
 Cod. **SAMG 81 R1** € 2.174,00
 Cod. **SAMO 81 R1** € 2.048,00

MOSE SB 81 **PRO**



Vaschetta forata

16

Sopratop
 Filotop
 Sottotop

Cod. **SBM I 81 R1** € 1.459,00
 Cod. **SBMG 81 R1** € 1.459,00
 Cod. **SBMO 81 R1** € 1.333,00

MOSE SB 81 **SOLO**



Materiale AISI 304
 Finitura Spazzolato
 Raggio interno Saldato 10 mm
 Misure esterne 810 × 440 mm
 Misure vasca 400 × 400 mm / 340 × 400 mm
 Profondità vasca 200 mm
 Piletta Standard Ø 3 ½"

Base 900 mm
 Sopratop
 Filotop
 Sottotop

Cod. **MI 8140 R1** € 1.255,00
 Cod. **MG 8140 R1** € 1.255,00
 Cod. **MO 8140 R1** € 1.129,00

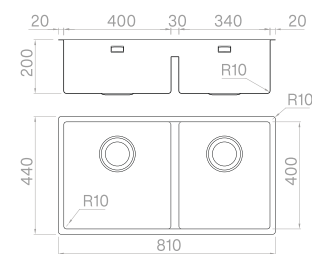

Accessori

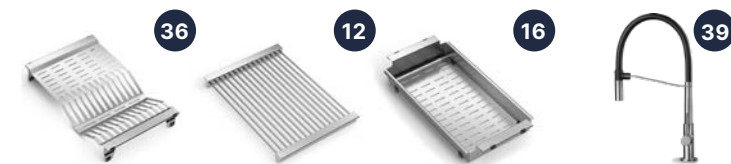

Vedi pag. 121 per tutti gli accessori dedicati.

MOSE SB 60 **READY**

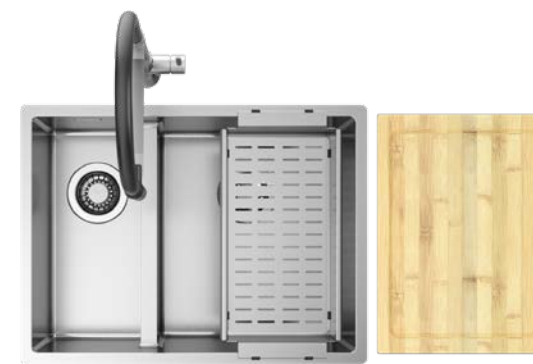

Tagliere in legno
Vaschetta forata
Miscelatore Hero

3
16
39

Sopratop
 Filotop
 Sottotop

Cod. **SAM I 60 R1** € 2.110,00
 Cod. **SAMG 60 R1** € 2.110,00
 Cod. **SAMO 60 R1** € 1.944,00

MOSE SB 60 **PRO**



Vaschetta forata

16

Sopratop
 Filotop
 Sottotop

Cod. **SBM I 60 R1** € 1.395,00
 Cod. **SBMG 60 R1** € 1.395,00
 Cod. **SBMO 60 R1** € 1.229,00

MOSE SB 60 **SOLO**



Materiale AISI 304
 Finitura Spazzolato
 Raggio interno Saldato 10 mm
 Misure esterne 590 × 440 mm
 Misure vasca 180 × 400 mm / 340 × 400 mm
 Profondità vasca 170 / 200 mm
 Piletta Standard Ø 3 ½"

Base 600 mm
 Sopratop
 Filotop
 Sottotop

Cod. **MI 6040 R1** € 1.191,00
 Cod. **MG 6040 R1** € 1.191,00
 Cod. **MO 6040 R1** € 1.025,00

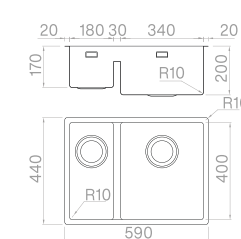

Accessori

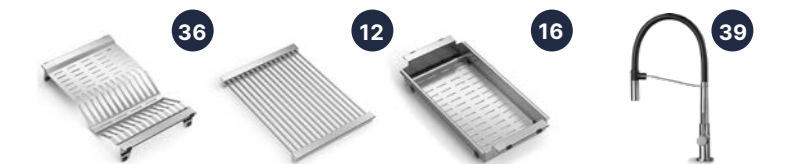

Vedi pag. 121 per tutti gli accessori dedicati.

Tagliere in legno**3**

300×420×20 mm

Cod. **TRIB 3042**

€ 137,00

**Tagliere in HDPE****6**

240×427×20 mm

Cod. **TRP 2442**

€ 149,00

**Griglia****12**

250×420×25 mm

Cod. **GRS 2542**

€ 260,00

**Vaschetta forata****16**

210×420×60 mm

Cod. **VQSF 2142**

€ 204,00

**Portapiatti****36**

250×420×55 mm

Cod. **PPPB V400**

€ 182,00



AQUA

Aqua è una collezione dalla grande capienza e dal design essenziale grazie agli angoli interni, sempre raggio di 10 mm. L'alloggiamento del miscelatore è integrato nell'area operativa.



AQUA 81

READY



Tagliere in legno
Vaschetta forata
Miscelatore Hero

3
16
39



Cod. **SAA I 81** € 1.969,00
Cod. **SAAG 81** € 1.969,00

AQUA 81

PRO



Vaschetta forata

16



Cod. **SBA I 81** € 1.254,00
Cod. **SBAG 81** € 1.254,00

AQUA 81

SOLO



Materiale AISI 304
Finitura Spazzolato
Raggio interno Saldato 10 mm
Misure esterne 850 × 510 mm
Misure vasca 810 × 400 mm
Profondità vasca 200 mm
Piletta Standard Ø 3 1/2"
Base 900 mm



Cod. **ALA I 81** € 1.050,00
Cod. **ALAG 81** € 1.050,00

Foro miscelatore:
specificare fori extra
in fase di ordine.

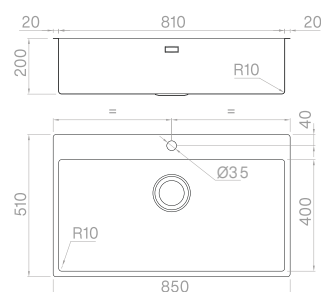

Accessori



Vedi pag. 129 per tutti gli accessori dedicati.

AQUA 70

READY



Tagliere in legno
Vaschetta forata
Miscelatore Element

3
16
40



Cod. **SAA I 70** € 2.097,00
Cod. **SAAG 70** € 2.097,00

AQUA 70

PRO



Vaschetta forata

16



Cod. **SBA I 70** € 1.133,00
Cod. **SBAG 70** € 1.133,00

AQUA 70

SOLO



Materiale AISI 304
Finitura Spazzolato
Raggio interno Saldato 10 mm
Misure esterne 740 × 510 mm
Misure vasca 700 × 400 mm
Profondità vasca 200 mm
Piletta Standard Ø 3 1/2"
Base 800 mm



Cod. **ALA I 70** € 929,00
Cod. **ALAG 70** € 929,00

Foro miscelatore:
specificare fori extra
in fase di ordine.

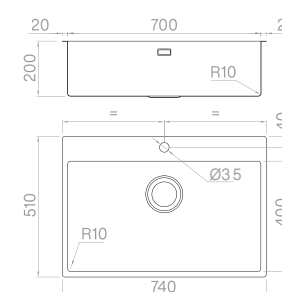

Accessori

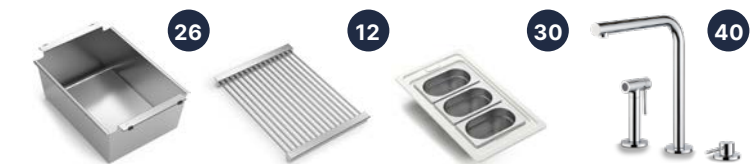

Vedi pag. 129 per tutti gli accessori dedicati.

AQUA 65

READY



Tagliere in legno
Vaschetta forata
Miscelatore Hero

3
16
39



Cod. **SAA I 65** € 2.065,00
Cod. **SAAG 65** € 2.065,00

AQUA 65

PRO



Vaschetta forata

16



Cod. **SBA I 65** € 1.075,00
Cod. **SBAG 65** € 1.075,00

AQUA 65

SOLO



Materiale AISI 304
Finitura Spazzolato
Raggio interno Saldato 10 mm
Misure esterne 690 × 510 mm
Misure vasca 650 × 400 mm
Profondità vasca 200 mm
Piletta Standard Ø 3 ½''
Base 750 mm



Cod. **ALA I 65** € 871,00
Cod. **ALAG 65** € 871,00

Foro miscelatore:
specificare fori extra
in fase di ordine.

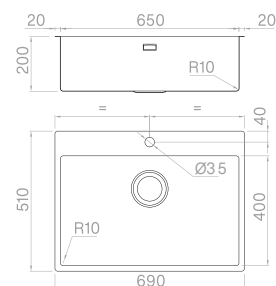

Accessori

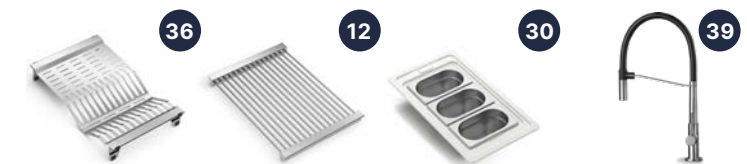

Vedi pag. 129 per tutti gli accessori dedicati.

AQUA 50

READY



Tagliere in legno
Vaschetta forata
Miscelatore Hero

3
16
39



Cod. **SAA I 50** € 2.006,00
Cod. **SAAG 50** € 2.006,00

AQUA 50

PRO



Vaschetta forata

16



Cod. **SBA I 50** € 1.016,00
Cod. **SBAG 50** € 1.016,00

AQUA 50

SOLO



Materiale AISI 304
Finitura Spazzolato
Raggio interno Saldato 10 mm
Misure esterne 540 × 510 mm
Misure vasca 500 × 400 mm
Profondità vasca 200 mm
Piletta Standard Ø 3 ½''
Base 600 mm



Cod. **ALA I 50** € 812,00
Cod. **ALAG 50** € 812,00

Foro miscelatore:
specificare fori extra
in fase di ordine.

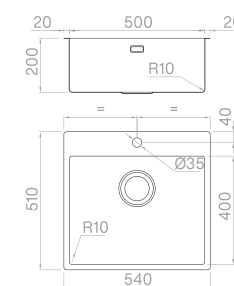

Accessori



Vedi pag. 129 per tutti gli accessori dedicati.

**Tagliere in legno****3**

300×420×20 mm

Cod. **TRIB 3042**

€ 137,00

**Tagliere in HDPE****6**

240×427×20 mm

Cod. **TRP 2442**

€ 149,00

**Griglia****12**

250×420×25 mm

Cod. **GRS 2542**

€ 260,00

**Vaschetta forata****16**

210×420×60 mm

Cod. **VQSF 2142**

€ 204,00

**Vaschetta inclinata forata****23**

280×420×110/60 mm

Cod. **VQSI 2842**

€ 242,00

**Vaschetta****26**

280×420×160 mm

Cod. **VQSP 2842**

€ 274,00

**Set gastronorm****30**

240×420×100 mm

Cod. **TI 2442 V**

€ 221,50

**Set scolapasta****32**

240×420×100 mm

Cod. **TI 2442 1S**

€ 170,00

**Set grattugie****34**

240×420×28 mm

Cod. **TI 2442 PG**

€ 351,00

**Portapiatti****36**

250×420×55 mm

Cod. **PPPB V400**

€ 182,00





PRISMA

Un connubio perfetto tra precisione e geometria: in Prisma gli angoli delle pareti a raggio zero si uniscono al fondo grazie a un esclusivo perimetro inclinato a 45°.



PRISMA 81

READY



- Tagliere in legno 3
- Vaschetta inclinata forata 23
- Vaschetta 26
- Miscelatore Element 40

- Sopratop Cod. **SAPR I 81** € 2.182,00
- Filotop Cod. **SAPRG 81** € 2.182,00
- Sottotop Cod. **SAPRO 81** € 2.099,00

PRISMA 81

PRO



- Vaschetta forata 16

- Sopratop Cod. **SBPR I 81** € 906,00
- Filotop Cod. **SBPRG 81** € 906,00
- Sottotop Cod. **SBPRO 81** € 823,00

PRISMA 81

SOLO



- Materiale AISI 304
- Finitura Spazzolato
- Raggio interno Saldato 10 mm
- Misure esterne 850 × 440 mm
- Misure vasca 810 × 400 mm
- Profondità vasca 200 mm
- Piletta Standard Ø 3 1/2"
- Base 900 mm

- Sopratop Cod. **PR I 81** € 702,00
- Filotop Cod. **PR G 81** € 702,00
- Sottotop Cod. **PR O 81** € 619,00

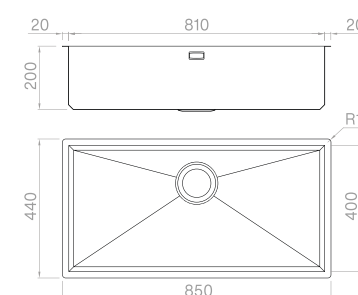

Accessori

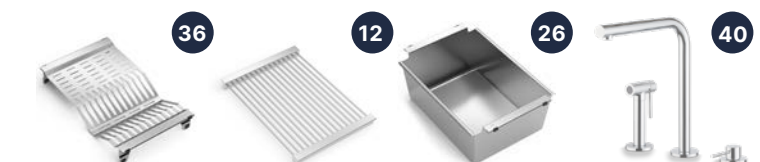

Vedi pag. 141 per tutti gli accessori dedicati.

PRISMA 70

READY



- Tagliere in legno
- Vaschetta inclinata forata
- Vaschetta
- Miscelatore Element

- 3
- 23
- 26
- 40

- Sopratop
- Filotop
- Sottotop

- Cod. **SAPR I 70** € 2.091,00
- Cod. **SAPRG 70** € 2.091,00
- Cod. **SAPRO 70** € 1.974,00

PRISMA 70

PRO



- Vaschetta forata

- 16

- Sopratop
- Filotop
- Sottotop

- Cod. **SBPR I 70** € 815,00
- Cod. **SBPRG 70** € 815,00
- Cod. **SBPRO 70** € 698,00

PRISMA 70

SOLO



- Materiale AISI 304
 - Finitura Spazzolato
 - Raggio interno Saldato 10 mm
 - Misure esterne 740 × 440 mm
 - Misure vasca 700 × 400 mm
 - Profondità vasca 200 mm
 - Piletta Standard Ø 3 ½"
 - Base 800 mm
- Sopratop Cod. **PR I 70** € 611,00
 - Filotop Cod. **PR G 70** € 611,00
 - Sottotop Cod. **PR O 70** € 494,00

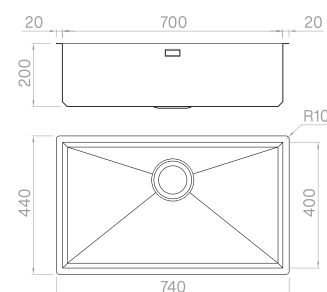

Accessori

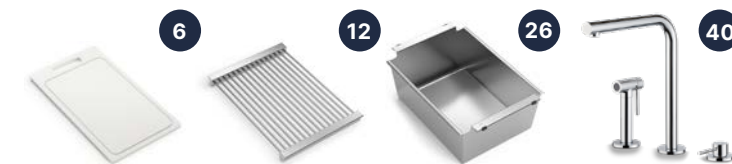

Vedi pag. 141 per tutti gli accessori dedicati.

PRISMA 65

READY



- Tagliere in legno
- Vaschetta inclinata forata
- Miscelatore Element

- 3
- 23
- 40

- Sopratop
- Filotop
- Sottotop

- Cod. **SAPR I 65** € 1.754,00
- Cod. **SAPRG 65** € 1.754,00
- Cod. **SAPRO 65** € 1.653,00

PRISMA 65

PRO



- Vaschetta forata

- 16

- Sopratop
- Filotop
- Sottotop

- Cod. **SBPR I 65** € 752,00
- Cod. **SBPRG 65** € 752,00
- Cod. **SBPRO 65** € 651,00

PRISMA 65

SOLO



- Materiale AISI 304
 - Finitura Spazzolato
 - Raggio interno Saldato 10 mm
 - Misure esterne 690 × 440 mm
 - Misure vasca 650 × 400 mm
 - Profondità vasca 200 mm
 - Piletta Standard Ø 3 ½"
 - Base 750 mm
- Sopratop Cod. **PR I 65** € 548,00
 - Filotop Cod. **PR G 65** € 548,00
 - Sottotop Cod. **PR O 65** € 447,00

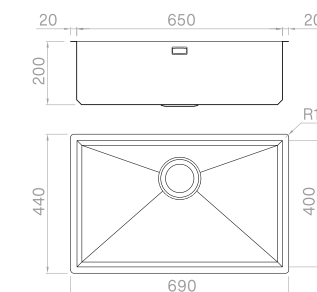

Accessori

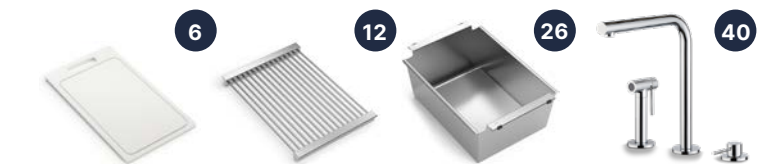

Vedi pag. 141 per tutti gli accessori dedicati.

PRISMA 50

READY



Tagliere in legno
 Vaschetta inclinata forata
 Miscelatore Vertigo

3
 23
 47

	Sopratop	Cod. SAPR I 50	€ 1.531,00
	Filotop	Cod. SAPRG 50	€ 1.616,00
	Sottotop	Cod. SAPRO 50	€ 1.531,00

PRISMA 45

READY

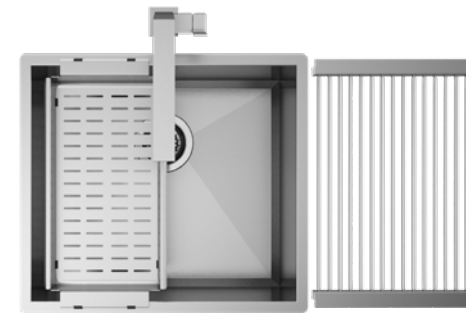

Griglia
 Vaschetta forata
 Miscelatore Vertigo

12
 16
 47

	Sopratop	Cod. SAPR I 45	€ 1.604,00
	Filotop	Cod. SAPRG 45	€ 1.585,00
	Sottotop	Cod. SAPRO 45	€ 1.516,00

PRISMA 50

PRO



Vaschetta forata

16

	Sopratop	Cod. SBPR I 50	€ 688,00
	Filotop	Cod. SBPRG 50	€ 688,00
	Sottotop	Cod. SBPRO 50	€ 603,00

PRISMA 45

PRO



Vaschetta forata

16

	Sopratop	Cod. SBPR I 45	€ 676,00
	Filotop	Cod. SBPRG 45	€ 684,00
	Sottotop	Cod. SBPRO 45	€ 588,00

PRISMA 50

SOLO



Materiale	AISI 304		
Finitura	Spazzolato		
Raggio interno	Saldato 10 mm		
Misure esterne	540 × 440 mm		
Misure vasca	500 × 400 mm		
Profondità vasca	200 mm		
Piletta Standard	Ø 3 ½"		
Base	600 mm		
	Sopratop	Cod. PR I 50	€ 484,00
	Filotop	Cod. PR G 50	€ 484,00
	Sottotop	Cod. PR O 50	€ 399,00

PRISMA 45

SOLO



Materiale	AISI 304		
Finitura	Spazzolato		
Raggio interno	Saldato 10 mm		
Misure esterne	490 × 440 mm		
Misure vasca	450 × 400 mm		
Profondità vasca	200 mm		
Piletta Standard	Ø 3 ½"		
Base	600 mm		
	Sopratop	Cod. PR I 45	€ 472,00
	Filotop	Cod. PR G 45	€ 453,00
	Sottotop	Cod. PR O 45	€ 384,00

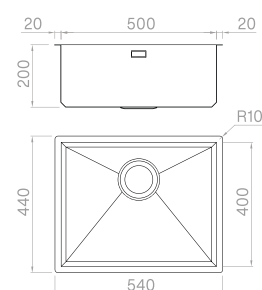

Accessori

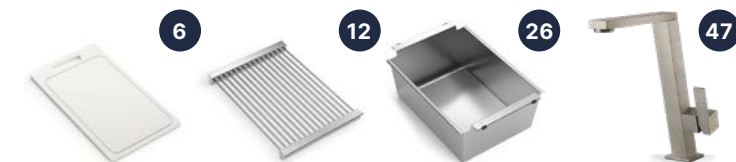

Vedi pag. 141 per tutti gli accessori dedicati.

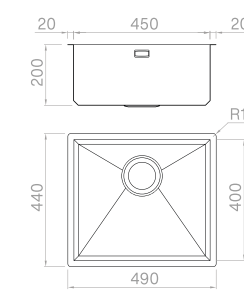

Accessori



Vedi pag. 141 per tutti gli accessori dedicati.

PRISMA 40 + 34

READY

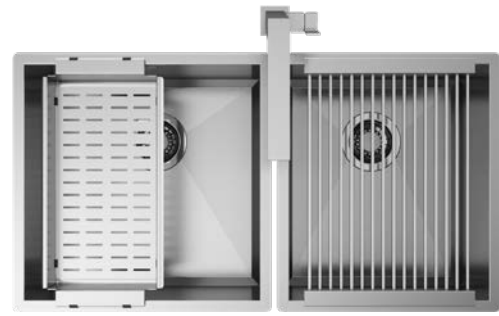

Griglia
Vaschetta forata
Miscelatore Vertigo

12
16
47

	Sopratop	Cod. SAPR I 40	€ 1.587,00
	Filotop	Cod. SAPRG 40	€ 1.587,00
	Sottotop	Cod. SAPRO 40	€ 1.502,00

PRISMA 34 + 34

READY

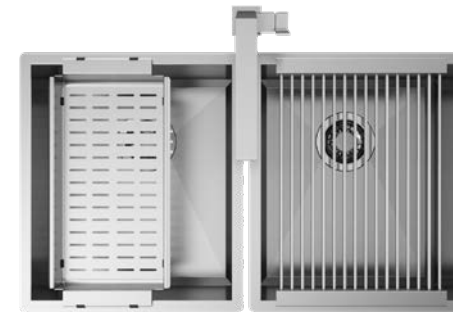

Griglia
Vaschetta forata
Miscelatore Vertigo

12
16
47

	Sopratop	Cod. SAPR I 34	€ 1.579,00
	Filotop	Cod. SAPRG 34	€ 1.579,00
	Sottotop	Cod. SAPRO 34	€ 1.490,00

PRISMA 40

PRO

Vaschetta forata

16



	Sopratop	Cod. SBPR I 40	€ 659,00
	Filotop	Cod. SBPRG 40	€ 659,00
	Sottotop	Cod. SBPRO 40	€ 574,00

PRISMA 34

PRO

Vaschetta forata

16



	Sopratop	Cod. SBPR I 34	€ 651,00
	Filotop	Cod. SBPRG 34	€ 651,00
	Sottotop	Cod. SBPRO 34	€ 562,00

PRISMA 40

SOLO

Materiale	AISI 304		
Finitura	Spazzolato		
Raggio interno	Saldato 10 mm		
Misure esterne	440 × 440 mm		
Misure vasca	400 × 400 mm		
Profondità vasca	200 mm		
Piletta Standard	Ø 3 ½"		
Base	600 mm		
	Sopratop	Cod. PR I 40	€ 455,00
	Filotop	Cod. PR G 40	€ 455,00
	Sottotop	Cod. PR O 40	€ 370,00

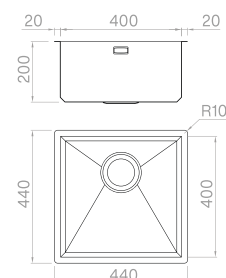

Accessori

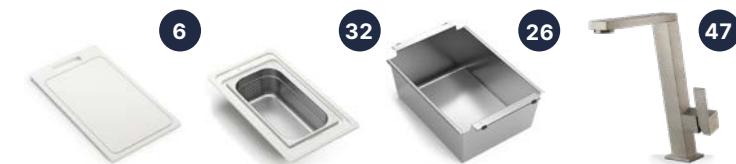

Vedi pag. 141 per tutti gli accessori dedicati.

PRISMA 34

SOLO

Materiale	AISI 304		
Finitura	Spazzolato		
Raggio interno	Saldato 10 mm		
Misure esterne	380 × 440 mm		
Misure vasca	340 × 400 mm		
Profondità vasca	200 mm		
Piletta Standard	Ø 3 ½"		
Base	600 mm		
	Sopratop	Cod. PR I 34	€ 447,00
	Filotop	Cod. PR G 34	€ 447,00
	Sottotop	Cod. PR O 34	€ 358,00

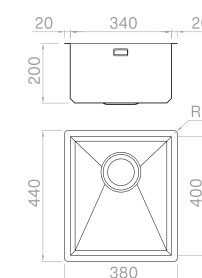

Accessori



Vedi pag. 141 per tutti gli accessori dedicati.

**Tagliere in legno****3**

300×420×20 mm

Cod. **TRIB 3042**

€ 137,00

**Tagliere in HDPE****6**

240×427×20 mm

Cod. **TRP 2442**

€ 149,00

**Griglia****12**

250×420×25 mm

Cod. **GRS 2542**

€ 260,00

**Vaschetta forata****16**

210×420×60 mm

Cod. **VQSF 2142**

€ 204,00

**Vaschetta inclinata forata****23**

280×420×110/60 mm

Cod. **VQSI 2842**

€ 242,00

**Vaschetta****26**

280×420×160 mm

Cod. **VQSP 2842**

€ 274,00

**Set gastronorm****30**

240×420×100 mm

Cod. **TI 2442 V**

€ 221,50

**Set scolapasta****32**

240×420×100 mm

Cod. **TI 2442 1S**

€ 170,00

**Set grattugie****34**

240×420×28 mm

Cod. **TI 2442 PG**

€ 351,00

**Portapiatti****36**

250×420×55 mm

Cod. **PPPB V400**

€ 182,00



LINEA

La caratteristica di Linea è l'esclusiva installazione Edgeless, dove bordo e giunzioni tra vasca e piano spariscono, massimizzando estetica e pulizia.



LINEA 70 **READY**



- Tagliere in legno
- Vaschetta inclinata forata
- Vaschetta
- Miscelatore Element

- 3
- 23
- 26
- 40

Edgeless Cod. **SAL 70** € 2.073,00

LINEA 70 **PRO**



Vaschetta forata **16**

Edgeless Cod. **SBL 70** € 797,00

LINEA 70 **SOLO**



- | | |
|------------------|---------------|
| Materiale | AISI 304 |
| Finitura | Spazzolato |
| Raggio interno | Saldato 10 mm |
| Misure esterne | - |
| Misure vasca | 700 × 400 mm |
| Profondità vasca | 200 mm |
| Piletta Standard | Ø 3 ½" |
| Base | 800 mm |

Edgeless Cod. **L 70** € 593,00

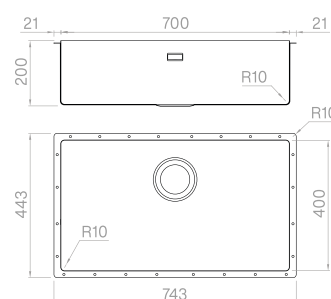

Accessori

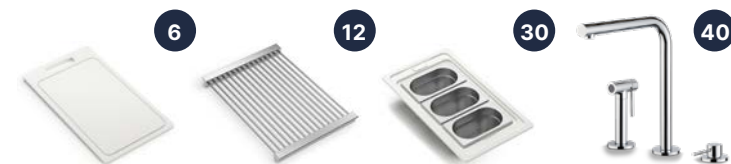

Vedi pag. 151 per tutti gli accessori dedicati.

LINEA 65 **READY**

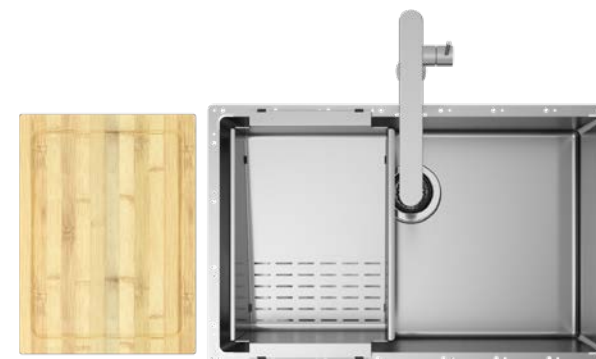

- Tagliere in legno
- Vaschetta inclinata forata
- Miscelatore Uber

- 3
- 23
- 46

Edgeless Cod. **SAL 65** € 1.420,00

LINEA 65 **PRO**



Vaschetta forata **16**

Edgeless Cod. **SBL 65** € 750,00

LINEA 65 **SOLO**



- | | |
|------------------|---------------|
| Materiale | AISI 304 |
| Finitura | Spazzolato |
| Raggio interno | Saldato 10 mm |
| Misure esterne | - |
| Misure vasca | 650 × 400 mm |
| Profondità vasca | 200 mm |
| Piletta Standard | Ø 3 ½" |
| Base | 750 mm |

Edgeless Cod. **L 65** € 546,00

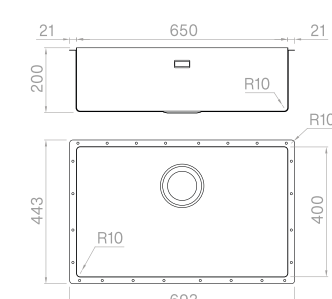

Accessori

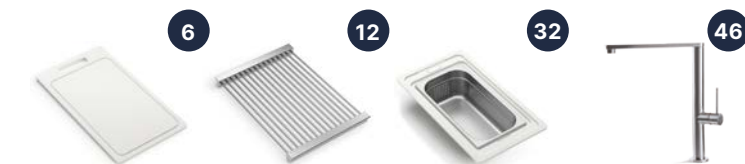

Vedi pag. 151 per tutti gli accessori dedicati.

LINEA 50

READY



- Tagliere in legno
- Vaschetta inclinata forata
- Miscelatore Uber

3
23
46



Cod. **SAL 50** € 1.366,00

LINEA 50

PRO



- Vaschetta forata

16



Cod. **SBL 50** € 696,00

LINEA 50

SOLO



- | | |
|------------------|---------------|
| Materiale | AISI 304 |
| Finitura | Spazzolato |
| Raggio interno | Saldato 10 mm |
| Misure esterne | - |
| Misure vasca | 500 × 400 mm |
| Profondità vasca | 200 mm |
| Piletta Standard | Ø 3 ½" |
| Base | 600 mm |



Cod. **L 50** € 492,00

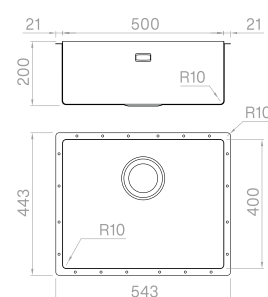

Accessori

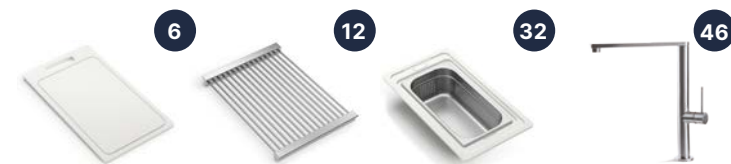

Vedi pag. 151 per tutti gli accessori dedicati.

LINEA 45

READY

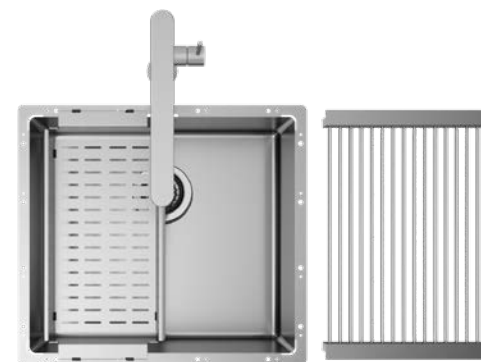

- Griglia
- Vaschetta forata
- Miscelatore Uber

12
16
46



Cod. **SAL 45** € 1.430,00

LINEA 45

PRO



- Vaschetta forata

16



Cod. **SBL 45** € 675,00

LINEA 45

SOLO



- | | |
|------------------|---------------|
| Materiale | AISI 304 |
| Finitura | Spazzolato |
| Raggio interno | Saldato 10 mm |
| Misure esterne | - |
| Misure vasca | 450 × 400 mm |
| Profondità vasca | 200 mm |
| Piletta Standard | Ø 3 ½" |
| Base | 600 mm |



Cod. **L 45** € 471,00

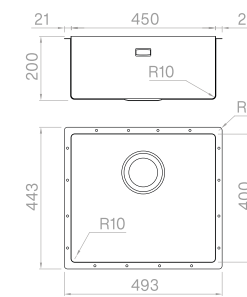

Accessori



Vedi pag. 151 per tutti gli accessori dedicati.

LINEA 40

READY

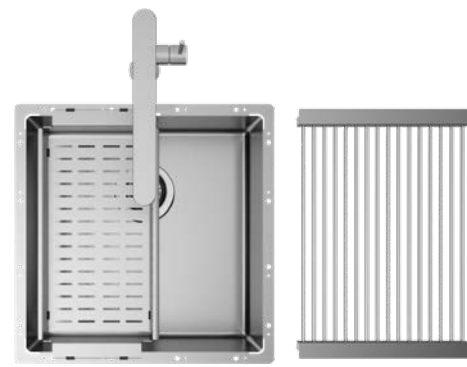

Griglia
Vaschetta forata
Miscelatore Uber

12
16
46

Edgeless

Cod. **SAL 40**

€ 1.416,00

LINEA 40

PRO



Vaschetta forata

16

Edgeless

Cod. **SBL 40**

€ 661,00

LINEA 40

SOLO



Materiale	AISI 304
Finitura	Spazzolato
Raggio interno	Saldato 10 mm
Misure esterne	-
Misure vasca	400 × 400 mm
Profondità vasca	200 mm
Piletta Standard	Ø 3 ½"
Base	600 mm

Edgeless

Cod. **L 40**

€ 457,00

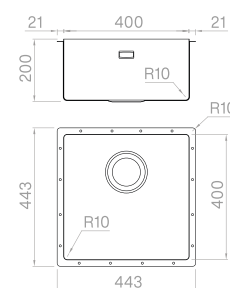

Accessori



Vedi pag. 151 per tutti gli accessori dedicati.

LINEA 34

READY

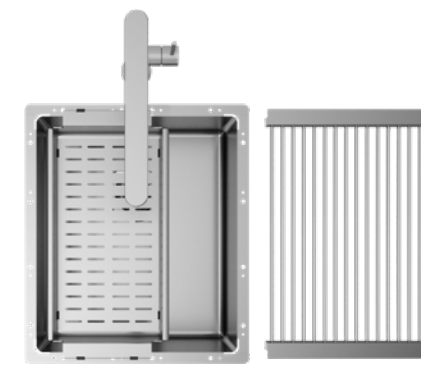

Griglia
Vaschetta forata
Miscelatore Uber

12
16
46

Edgeless

Cod. **SAL 34**

€ 1.394,00

LINEA 34

PRO



Vaschetta forata

16

Edgeless

Cod. **SBL 34**

€ 639,00

LINEA 34

SOLO



Materiale	AISI 304
Finitura	Spazzolato
Raggio interno	Saldato 10 mm
Misure esterne	-
Misure vasca	340 × 400 mm
Profondità vasca	200 mm
Piletta Standard	Ø 3 ½"
Base	600 mm

Edgeless

Cod. **L 34**

€ 435,00

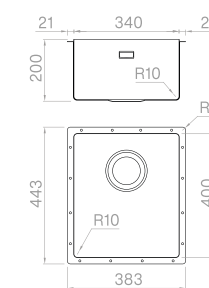

Accessori



Vedi pag. 151 per tutti gli accessori dedicati.

**Tagliere in legno****3**300×420×20 mm
Cod. **TRIB 3042**

€ 137,00

**Tagliere in HDPE****6**240×427×20 mm
Cod. **TRP 2442**

€ 149,00

**Griglia****12**250×420×25 mm
Cod. **GRS 2542**

€ 260,00

**Vaschetta forata****16**210×420×60 mm
Cod. **VQSF 2142**

€ 204,00

**Vaschetta inclinata forata****23**280×420×110/60 mm
Cod. **VQSI 2842**

€ 242,00

**Vaschetta****26**280×420×160 mm
Cod. **VQSP 2842**

€ 274,00

**Set gastronorm****30**240×420×100 mm
Cod. **TI 2442 V**

€ 221,50

**Set scolapasta****32**240×420×20 mm
Cod. **TI 2442 1S**

€ 170,00

**Set grattugie****34**240×420×28 mm
Cod. **TI 2442 PG**

€ 351,00

**Portapiatti****36**250×420×55 mm
Cod. **PPPB V400**

€ 182,00



SHORE

Shore presenta l'innovativa installazione con pareti in continuità al piano di lavoro e il fondo in acciaio inox a vista dall'esclusivo perimetro inclinato a 45°.



SHORE 70

READY



Tagliere in legno
Vaschetta inclinata forata
Miscelatore Element

3
23
40

Integrato Cod. **SASH 70** € 1.578,00

SHORE 70

PRO



Vaschetta forata

16

Integrato Cod. **SBSH 70** € 576,00

SHORE 70

SOLO



Materiale	AISI 304
Finitura	Spazzolato
Raggio interno	Saldato 10 mm
Misure esterne	-
Misure vasca	700 × 400 mm
Profondità vasca	180 mm
Piletta Standard	Ø 3 ½"
Base	800 mm

Integrato Cod. **SH 70** € 372,00

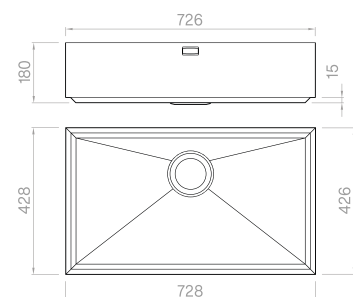

Accessori



Vedi pag. 161 per tutti gli accessori dedicati.

SHORE 65

READY



Tagliere in legno
Vaschetta inclinata forata
Miscelatore Element

3
23
40

Integrato Cod. **SASH 65** € 1.561,00

SHORE 65

PRO



Vaschetta forata

16

Integrato Cod. **SBSH 65** € 559,00

SHORE 65

SOLO



Materiale	AISI 304
Finitura	Spazzolato
Raggio interno	Saldato 10 mm
Misure esterne	-
Misure vasca	650 × 400 mm
Profondità vasca	180 mm
Piletta Standard	Ø 3 ½"
Base	750 mm

Integrato Cod. **SH 65** € 355,00

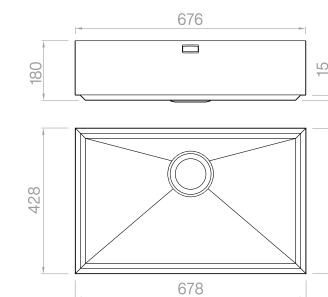

Accessori



Vedi pag. 161 per tutti gli accessori dedicati.

SHORE 50

READY



Tagliere in legno
Vaschetta inclinata forata
Miscelatore Element

3
23
40

Integrato Cod. **SASH 50** € 1.523,00

SHORE 50

PRO



Vaschetta forata

16

Integrato Cod. **SBSH 50** € 521,00

SHORE 50

SOLO



Materiale	AISI 304
Finitura	Spazzolato
Raggio interno	Saldato 10 mm
Misure esterne	-
Misure vasca	500 × 400 mm
Profondità vasca	180 mm
Piletta Standard	Ø 3 ½"
Base	600 mm

Integrato Cod. **SH 50** € 317,00

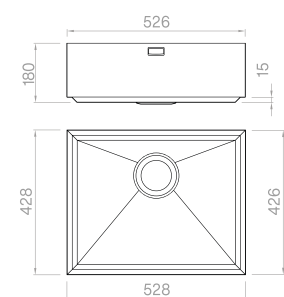

Accessori

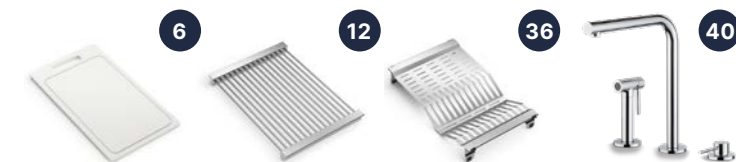

Vedi pag. 161 per tutti gli accessori dedicati.

SHORE 45

READY

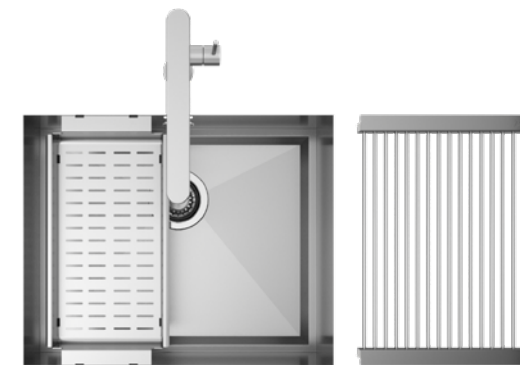

Griglia
Vaschetta forata
Miscelatore Uber

12
16
46

Integrato Cod. **SASH 45** € 1.301,00

SHORE 45

PRO



Vaschetta forata

16

Integrato Cod. **SBSH 45** € 508,00

SHORE 45

SOLO



Materiale	AISI 304
Finitura	Spazzolato
Raggio interno	Saldato 10 mm
Misure esterne	-
Misure vasca	450 × 400 mm
Profondità vasca	180 mm
Piletta Standard	Ø 3 ½"
Base	600 mm

Integrato Cod. **SH 45** € 304,00

Accessori



Vedi pag. 161 per tutti gli accessori dedicati.

SHORE 40 + 34

READY

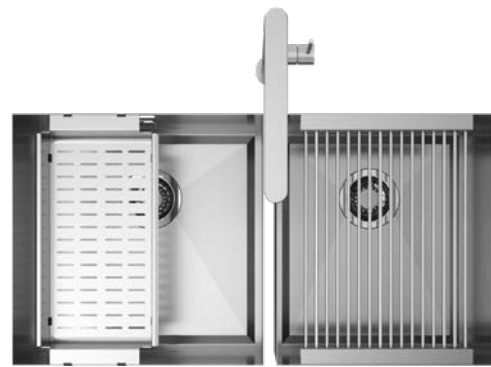

Griglia
Vaschetta forata
Miscelatore Uber

12
16
46

Integrato

Cod. **SASH 40**

€ 1.291,00

SHORE 34 + 34

READY

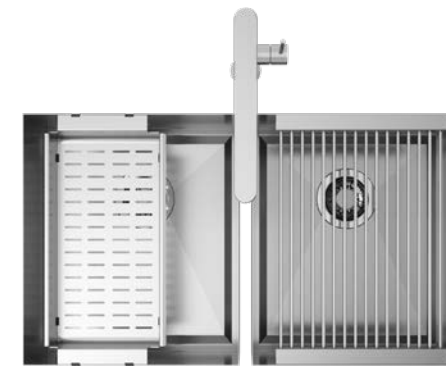

Griglia
Vaschetta forata
Miscelatore Uber

12
16
46

Integrato

Cod. **SASH 34**

€ 1.281,00

SHORE 40

PRO



Vaschetta forata

16

Integrato

Cod. **SBSH 40**

€ 498,00

SHORE 34

PRO



Vaschetta forata

16

Integrato

Cod. **SBSH 34**

€ 488,00

SHORE 40

SOLO



Materiale	AISI 304
Finitura	Spazzolato
Raggio interno	Saldato 10 mm
Misure esterne	-
Misure vasca	400 × 400 mm
Profondità vasca	180 mm
Piletta Standard	Ø 3 ½"
Base	600 mm

Integrato

Cod. **SH 40**

€ 294,00

SHORE 34

SOLO



Materiale	AISI 304
Finitura	Spazzolato
Raggio interno	Saldato 10 mm
Misure esterne	-
Misure vasca	340 × 400 mm
Profondità vasca	180 mm
Piletta Standard	Ø 3 ½"
Base	600 mm

Integrato

Cod. **SH 34**

€ 284,00

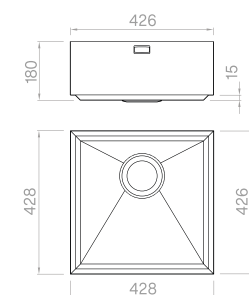

Accessori



Vedi pag. 161 per tutti gli accessori dedicati.

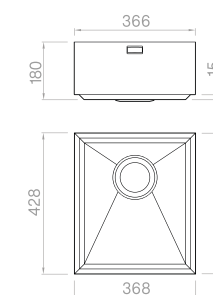

Accessori



Vedi pag. 161 per tutti gli accessori dedicati.

Tagliere in legno**3**

300×420×20 mm

Cod. **TRIB 3042**

€ 137,00

**Tagliere in HDPE****6**

240×427×20 mm

Cod. **TRP 2442**

€ 149,00

**Griglia****12**

250×420×25 mm

Cod. **GRS 2542**

€ 260,00

**Vaschetta forata****16**

210×420×60 mm

Cod. **VQSF 2142**

€ 204,00

**Vaschetta inclinata forata****23**

280×420×110/60 mm

Cod. **VQSI 2842**

€ 242,00

**Vaschetta****26**

280×420×160 mm

Cod. **VQSP 2842**

€ 274,00

**Set gastronorm****30**

240×420×100 mm

Cod. **TI 2442 V**

€ 221,50

**Set scolapasta****32**

240×420×100 mm

Cod. **TI 2442 1S**

€ 170,00

**Set grattugie****34**

240×420×28 mm

Cod. **TI 2442 PG**

€ 351,00

**Portapiatti****36**

250×420×55 mm

Cod. **PPPB V400**

€ 182,00



MISCELATORI

I miscelatori Artinox sono prodotti da selezionati partner italiani, disponibili in tutte le finiture Artinox per soluzioni monocromatiche dall'altissimo impatto estetico.



LOFT



38

Materiale	Acciaio inox AISI 304
Finitura	Spazzolato
Rotazione canna	180°
Foro installazione	Ø 35 mm
Cartuccia	disco ceramico
Doccetta	estraibile

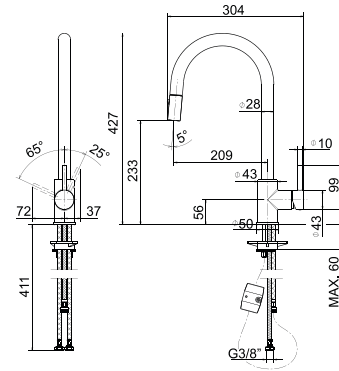
Cod. **SS 02726** € 853,00

HERO



39

Finitura	Inox spazzolato
Rotazione canna	360°
Foro installazione	Ø 35 mm
Cartuccia	disco ceramico
Doccetta	flessibile con magnete

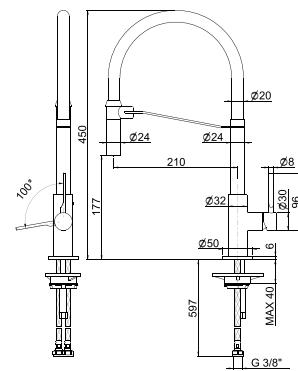
Cod. **SS 02724** € 578,00

ELEMENT



40

Finitura	Inox spazzolato
Rotazione canna	360°
Foro installazione	Ø 35 mm
Cartuccia	disco ceramico
Doccetta	estraibile

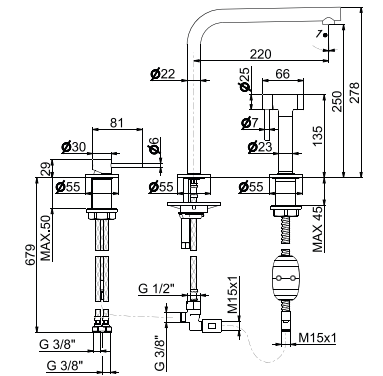
Cod. **SS 02725** € 827,00

ERGO MATTE BLACK



41

Finitura	Nero opaco
Rotazione canna	360°
Foro installazione	Ø 35 mm
Cartuccia	disco ceramico
Doccetta	estraibile

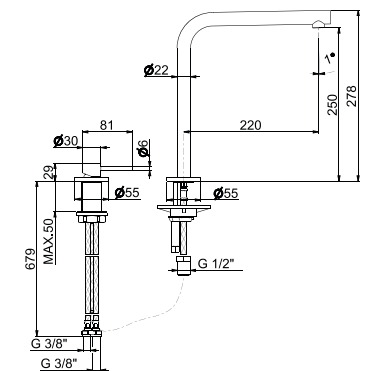
Cod. **SS 02727** € 619,00

ATHOM GUN METAL

42

Finitura	PVD Gun Metal
Rotazione canna	180°
Foro installazione	Ø 35 mm
Cartuccia	disco ceramico
Doccetta	estraibile

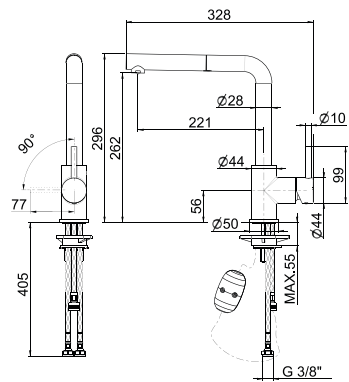
Cod. **SS 02721** € 632,00

ATHOM COPPER BRONZE

43

Finitura	PVD Copper Bronze
Rotazione canna	180°
Foro installazione	Ø 35 mm
Cartuccia	disco ceramico
Doccetta	estraibile

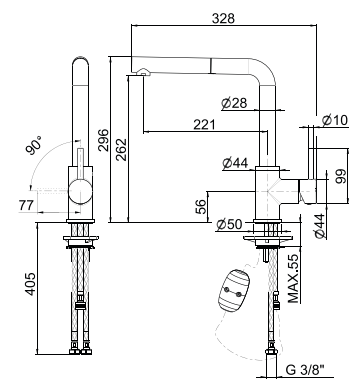
Cod. **SS 02722** € 632,00

ATHOM PALE GOLD

44

Finitura	PVD Pale Gold
Rotazione canna	180°
Foro installazione	Ø 35 mm
Cartuccia	disco ceramico
Doccetta	estraibile

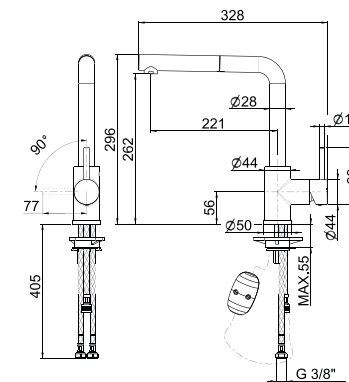
Cod. **SS 02723** € 632,00

CIRCLE

45

Finitura	Inox spazzolato
Rotazione canna	360°
Foro installazione	Ø 35 mm
Cartuccia	disco ceramico
Doccetta	estraibile

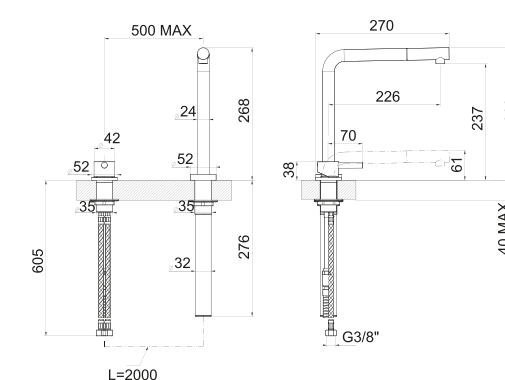
Cod. **SS 02700** € 640,00

UBER

46

Materiale	Acciaio inox AISI 304
Finitura	Spazzolato
Rotazione canna	360°
Foro installazione	Ø 35 mm
Cartuccia	disco ceramico

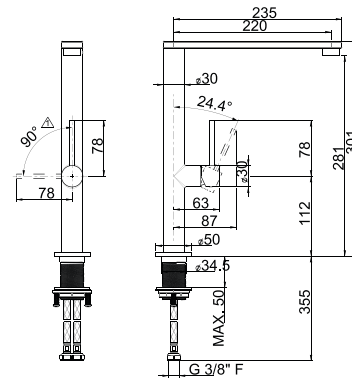

Cod. **SS 02720** € 495,00

VERTIGO

47

Finitura	Inox spazzolato
Rotazione canna	360°
Foro installazione	Ø 35 mm
Cartuccia	disco ceramico

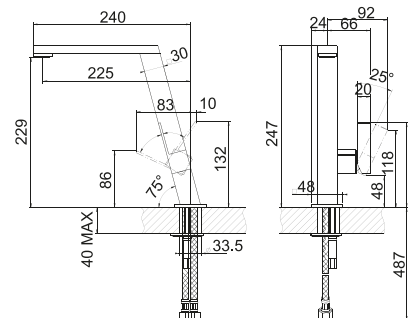

Cod. **SS 01164** € 668,00



COMPLEMENTI

PILETTE E TROPPOIENI



PLUS – SATINATO

Cod. **SS 02608**
€ 45,00



STANDARD – SATINATO

Cod. **SS 02740**
€ 37,00



BLACK – NERO OPACO

Cod. **SS 02741**
€ 45,00

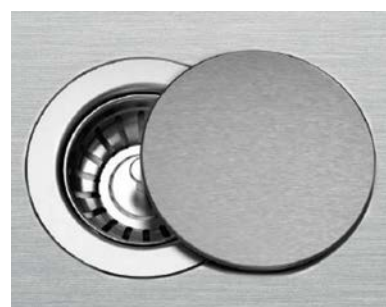

ECLISSE – SATINATO

Permette il deflusso.
Compatibile con pilette tonde ø 3,5".

Cod. **SS 02748**
€ 25,00

PILETTE E TROPPOIENI TITANIUM



PLUS – GUN METAL

Cod. **SS 02717**
€ 75,00

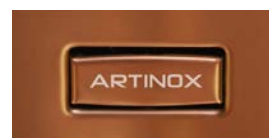

PLUS – COPPER BRONZE

Cod. **SS 02716**
€ 75,00

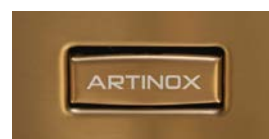

PLUS – PALE GOLD

Cod. **SS 02715**
€ 75,00

PILETTE AUTOMATICHE

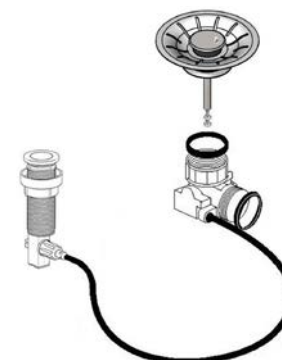

SALTARELLO – PLUS

Azionamento a pressione.
Cestello e pulsante comando satinati.
Cod. **SS 02744** € 58,00

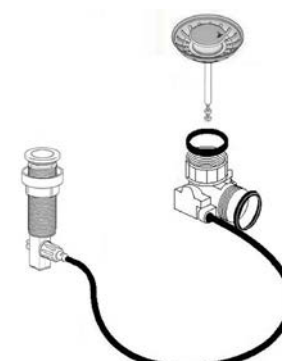

SALTARELLO – STANDARD

Azionamento a pressione.
Cestello e comando satinati.
Cod. **SS 02742** € 58,00

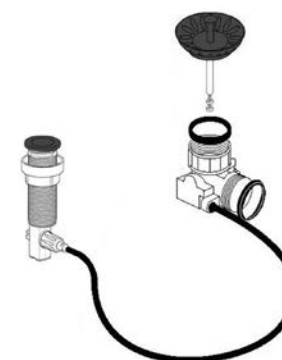

SALTARELLO – BLACK

Azionamento a pressione. Cestello e pulsante comando in nero opaco.
Cod. **SS 02743** € 58,00



PILETTE AUTOMATICHE TITANIUM

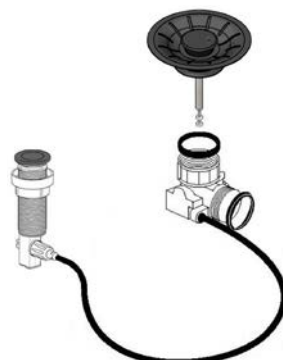

SALTARELLO – PLUS

Gun Metal – Azionamento a pressione.
Cestello e pulsante comando in PVD.
Cod. **SS 02747** € 86,00

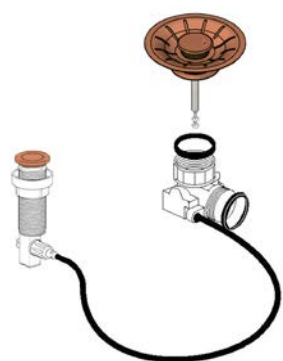

SALTARELLO – PLUS

Copper Bronze – Azionamento a pressione. Cestello e pulsante comando in PVD.
Cod. **SS 02746** € 86,00

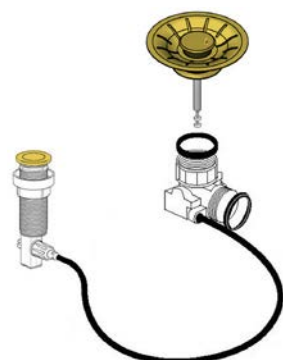

SALTARELLO – PLUS

Pale Gold – Azionamento a pressione. Cestello e pulsante comando in PVD.
Cod. **SS 02745** € 86,00



SIFONI



Attacco salvaspazio per lavelli a uno scarico; con attacco per lavastoviglie.

Cod. **Una Via SS 00448** € 18,00
Cod. **Due Vie SS 00449** € 26,00

DISSIPATORE ALIMENTARE



In acciaio spazzolato, permette il deflusso.
Compatibile con pilette tonde Ø 3 1/2".
Titanium e Matte Vintage non disponibili.

Cod. **TRFWD 60T** € 697,00

CURA DELL'ACCIAIO INOX



PULIZIA - KIT COMPLETO

- Crema detergente (flacone da 250 ml)
- Panno per pulizia
- Panno di finitura

Cod. **SS 01751** € 47,00
Cod. **SS 02771** (12 Conf.) € 517,00

CREMA DETERGENTE

Specifica per la pulizia dell'acciaio
inox – flacone da 250 ml.

Cod. **SS 02790** € 18,00
Cod. **SS 02772** (12 Pz.) € 198,00

PANNO ANTIBATTERICO

In microfibra per finiture
– dimensione 40x40 cm.
Confezione da 3 pezzi.

Cod. **SS 02773** € 38,00
Cod. **SS 02774** (12 Conf.) € 418,00

I lavelli workstation di ARTINOX sono realizzati in acciaio inox AISI 304 18/10 (EN 1.4301), una lega di acciaio al cromo e nichel. L'acciaio inox è il materiale igienico per eccellenza, tenace e molto resistente alla corrosione, il prodotto ideale per il contatto con gli alimenti. Tutti gli articoli ARTINOX sono realizzati rispettando i più severi standard qualitativi e testati uno ad uno.

AVVERTENZE

Come tutti i materiali anche l'acciaio inox richiede una cura regolare ed una pulizia quotidiana. L'uso improprio può danneggiare la superficie anche in modo permanente.

I seguenti consigli proteggono il lavello dai danni causati dalla corrosione di detersivi non idonei alla pulizia.

PULIZIA

Per la pulizia quotidiana consigliamo di strizzare una spugna dall'acqua calda e bagnarla con aceto bianco. Per una pulizia profonda utilizzare SOLO prodotti ufficiali Artinox, acquistabili presso i rivenditori autorizzati o consultando www.artinox.com.

MANTENIMENTO

Dopo ogni uso, pulire, risciacquare ed asciugare accuratamente il lavello con un panno morbido.

NON lasciare detersivi e prodotti per la pulizia a lungo a contatto con la superficie.

NON utilizzare acido cloridrico, acido fluoridrico, acido fosforico, candeggina, ammoniacca, o detersivi che contengono anche minime dosi tali sostanze.

NON utilizzare spugne, detersivi e creme abrasive.

NON lasciare oggetti, metalli ferrosi e non ferrosi all'interno del lavello.

CONDIZIONI GENERALI DI VENDITA

Come ordinare:

Si accettano solo ordini scritti e completi. L'ordine dovrà indicare i codici delle singole parti come nel presente listino indicati. Seguirà nostra conferma d'ordine che si intende corretta ed accettata se non contestata entro 3 giorni dalla data di invio a mezzo posta elettronica, fax. La società Artinox S.p.A. si riserva la facoltà, qualora si rendesse opportuno, di variare, modificare e/o annullare, i prodotti, le misure, le descrizioni, i prezzi indicati sul presente listino in qualsiasi momento senza bisogno di alcun preavviso e ciò senza possibilità di rivendicazioni da parte dell'acquirente.

Consegna:

I termini di consegna sono indicativi e si intendono in condizioni normali di lavoro e sono presso l'Artinox. In nessun caso potrà essere richiesto alla venditrice il rimborso per eventuali danni per ritardata consegna, né il ritardo può costituire motivo di rescissione del contratto. L'acquirente ha infatti rinunciato a far valere ogni domanda, azione ed eccezione in ordine a tali ipotesi. La verifica della qualità e del tipo di merce deve essere fatta dal compratore alla consegna.

Resa:

franco nostro stabilimento di Conegliano (Treviso) Italia. La merce viaggia a rischio e pericolo dell'acquirente anche nei casi in cui il prodotto, per accordi diversi, sia reso franco destino.

Imballo:

Imballo standard in scatole di cartone gratuite o con imballo adeguato è compreso nel prezzo. Imballi speciali verranno addebitati al costo.

Prezzi:

I prezzi del presente listino non comprendono: i.v.a., trasporto, imballi speciali, oneri doganali, gabbie e/o bancali in legno, montaggio e collaudo.

Condizioni di pagamento:

Da convenire. Tutti gli oneri relativi al pagamento di commissioni bancarie, bolli, ecc. saranno addebitati in fattura. Nel caso di ritardi di pagamenti, l'azienda si riserva il diritto di sospendere la consegna degli ordini in corso, senza obbligo di alcuna comunicazione. Le parti espressamente convengono che l'acquirente acquisterà la proprietà del materiale all'atto del pagamento integrale del prezzo complessivo concordato, oltre gli accessori, ma ne assumerà i rischi dal momento della consegna ex art. 1523 c.c. In seguito alla scadenza dei termini concordati dalle parti per il pagamento del materiale, nessun reclamo riguardante la qualità della merce potrà essere fatto valere, neppure in via d'eccezione, in sede giudiziaria, se regolare pagamento alla quale il reclamo si riferisce non avrà ancora avuto luogo.

Interessi di mora:

Il ritardato pagamento comporta automaticamente, senza pertanto bisogno di particolari diffide, l'addebito degli interessi di mora 1,5% mensile dal giorno successivo di scadenza del pagamento indicato in fattura. Saranno addebitate, inoltre, tutte le spese sostenute per il recupero delle somme dovute.

Garanzia:

La garanzia è di 24 mesi dalla data di spedizione e si intende sulle singole parti. Il venditore non risponde dei danni diretti e/o indiretti provocati dalle e/o alle attrezzature, impianti, persone per uso improprio o colposo delle stesse, per urti, per installazione non corretta, per utilizzazione fuori tolleranza.

Tutti i difetti visivi quali botte, graffi, macchie o rotture devono essere tassativamente segnalati prima dell'installazione e/o utilizzo. Le difettosità riportate sopra saranno escluse dalla garanzia qualora venissero segnalate successivamente all'installazione poiché non riconducibili a difetti di origine.

I pezzi difettosi dovranno essere resi, previa autorizzazione scritta della Artinox, franco stabilimento di Conegliano (Treviso) Italia e saranno sostituiti in garanzia solo dopo verifica. I pezzi riconosciuti difettosi saranno sostituiti e spediti franco destino a mezzo corriere. La garanzia non copre i costi relativi alla sostituzione del pezzo, è valida soltanto nei confronti dell'acquirente originario.

Ogni articolo in questo catalogo è prodotto in conformità alle normative vigenti e alle direttive CE.

Tutti i dati riportati non sono vincolanti.

Artinox S.p.a. si riserva la facoltà di apportare modifiche ritenute utili al miglioramento della propria offerta in qualsiasi momento, senza preavviso e declinando ogni responsabilità per eventuali errori o inesattezze.

La riproduzione delle colorazioni a catalogo sono da ritenersi indicative.

Sono vietate le riproduzioni nel suo insieme o in parte del presente catalogo, senza la specifica autorizzazione scritta di Artinox S.p.a.

© Copyright 2023 Artinox S.p.a. - Tutti i diritti riservati.

Edizione 1 - Febbraio 2023



Artinox S.p.a. è certificata UNI EN ISO 9001 e UNI EN ISO 14001

C0041-3000-02/2023

Concept: Artinox S.p.A.

Graphic design: Marta Amistani – topvisualbeauty.com

Photography: Michele Sallucci – Immaginarìa Srl

Print: Trevisostampa

www.artinox.com

domestic@artinox.com