

KITCHEN

CATALOGO LISTINO 2023

EVERY

DAY

choices
make
your

LIFE



KITCHEN

CATALOGO LISTINO 2023

30TH
ANNIVERSARY

UNA STORIA DA RACCONTARE, UN'ESPERIENZA DA CONDIVIDERE.
A STORY TO TELL, AN EXPERIENCE TO SHARE.



MADE IN ITALY

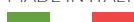

**FOCUSED
ON LIFE**
MAKING
IT EASIER



INDEX

Una gamma di prodotti completa e coordinabile; design, funzionalità e praticità al servizio delle esigenze quotidiane.

Con passione e dedizione lunghe 30 anni, Elleci crea soluzioni intelligenti con lo scopo di rendere più semplice la vita di tutti i giorni in cucina e lasciare spazio ai momenti che contano.

04 HERITAGE

06 EXPERTISE

08 SUSTAINABILITY

10 MATERIALS KERATEK | GRANITEK

14 CHOICES THAT MATTER

16 FLOW-PRO

18 EVERY DAY LIFE

20 BREAKFAST

22 LUNCH

24 HAPPY HOUR

26 DINNER

28-35 WHAT'S NEW

36 CARE FOR ATTENTION

38 PRODOTTI

44 LAVELLI IN COMPOSITO

128 LAVELLI INOX

140 ACCESSORI

152 MISCELATORI

172 PIANI COTTURA

186 FORNI

196 CAPPE E DISSIPATORI

200 ELLECI BEAUTY

202 SPARE PARTS

HERITAGE

A STORY TO TELL, AN EXPERIENCE TO SHARE.



Elleci guarda al futuro
con occhi sempre nuovi.
Una Company Culture che,
basata sulla tradizione da cui
si sviluppano le idee di domani,
ha permesso di collezionare
nel tempo importanti traguardi,
innovando e proponendo
un nuovo modo di vivere
l'area preparazione in cucina.

UNA STORIA DI SUCCESSO

*Tra i riconoscimenti più rilevanti,
troviamo "Storie di Eccellenza"
all'interno della Manifestazione
100 Eccellenze, riservato
alle aziende italiane che,
con il loro lavoro, hanno
contribuito a rafforzare
i valori e lo spirito
dell'ingegno nazionale.*



EVOLUZIONE ARCHITETTONICA DEI COMPLESSI PRODUTTIVI

Dal 1992 a oggi, un'architettura pensata
per visualizzare ogni volta
l'espressione del proprio tempo.



MIDA TERRA DI FRANCIA
Il 1° lavello prodotto.

FOR 30 YEARS ALWAYS A STEP AHEAD.



LEADERSHIP TECNOLOGICA

Ricerca, sperimentazione e tecnologie applicate accompagnano il prodotto dall'inizio alla fine del processo di creazione.

Gli anni passano, la passione per l'innovazione resta.
Da 30 anni la voglia di migliorare è rimasta la stessa con idee in continuo aggiornamento e prodotti sempre attuali.

Dal principio alla prospettiva futura, il team Elleci è costantemente impegnato nella ricerca delle migliori soluzioni ergonomiche. Guidare l'evoluzione del gusto in cucina attraverso creatività e progresso tecnologico è il punto focale dell'azienda, per emozioni sempre nuove.



SPAZIO 900
Red Dot Product Design 2023
IF Design Award 2023

EXPERTISE

ANTICIPATING THE FUTURE IS THE BASIS OF OUR SUCCESS.



Il team di ricerca e sviluppo Elleci si compone di professionisti costantemente impegnati nella formulazione di soluzioni innovative, con una visione aziendale basata sullo sviluppo del know how interno e sul raggiungimento dell'eccellenza. Nuovi materiali extra resistenti, prodotti dal design intelligente e processi

produttivi della massima efficienza. Tra le innovazioni spicca il sistema G.P.S. (Granitek Production System) in grado di distribuire in maniera uniforme tutti i componenti inclusi nella massa in modo da conferire alle superfici un look & feel unico e una maggiore resistenza agli shock termici, all'abrasione e agli urti.

INNOVATION FIRST.

Passione, dedizione e cura al dettaglio in ogni fase della filiera produttiva.

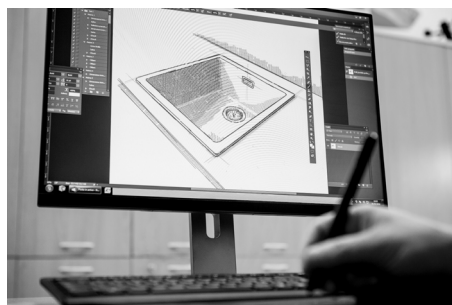

CERTIFICAZIONI
QUALITÀ CERTIFICATA AL 100%



ISO 9001/2015
 per la gestione della qualità a garanzia della soddisfazione del cliente, in termini di continuo sviluppo e miglioramento delle performance aziendali.



ISO 14001/2015
 per la gestione ambientale in termini di corretto impatto dell'attività dell'azienda nell'ecosistema.



ISO 45001/2018
 per la gestione della salute e della sicurezza sul lavoro aziendale.



Il materiale dei lavelli Elleci è altamente igienico ed idoneo al contatto alimentare in conformità alle norme e procedure imposte dall'ente.



I lavelli in composito Elleci sono conformi alle più rigorose normative in termini di livelli di emissione dei composti organici volatili.

Lavello_Ego 500 G68 Bianco
 Miscelatore_Volta G68 Bianco

SUSTAINABILITY

FROM THE WORLD OF MATTER, FOR A WORLD THAT MATTERS.

L'innovazione è responsabilità e diviene sostenibile se affrontata con intelligenza. Pensare al domani e alle nuove generazioni vuol dire immaginare un futuro possibile per un mondo migliore.

L'impegno di Elleci si concentra sulla riduzione dell'impatto ambientale attraverso tutte le fasi produttive: dal design di prodotto alla scelta dei materiali e delle finiture, dalla progettazione e produzione fino alle soluzioni di smaltimento dei rifiuti e degli scarti.



PRODOTTO CERTIFICATO PER BASSE EMISSIONI CHIMICHE
UL.COM/GG
UL2818



ACQUA
RECUPERO
RAFFREDDAMENTO
E RE-IMMISSIONE

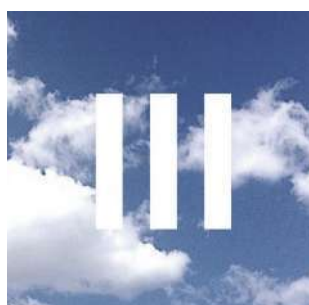

ARIA
RIDUZIONI
EMISSIONI
DI CO2



TERRA
RIUTILIZZO
SCARTI
DI PRODUZIONE



FUOCO
PRODUZIONE ENERGIA
DA FONTI RINNOVABILI

OUR PATH TO A SUSTAINABLE FUTURE.

INNOVAZIONE, SOSTENIBILITÀ E VISIONE ORIENTATA AL FUTURO.

Da anni Elleci rivolge le sue attenzioni verso pratiche di salvaguardia ambientale, cercando sempre nuove soluzioni per uno sviluppo aziendale sostenibile.

1_ ELLECI HUB 1

Impianto produttivo storico incentrato sulla flessibilità e customizzazione della produzione.

2_ ELLECI HUB 2

Impianto produttivo indipendente, altamente sostenibile e tecnologico in cui tradizione e know how incontrano modernità e automazione.

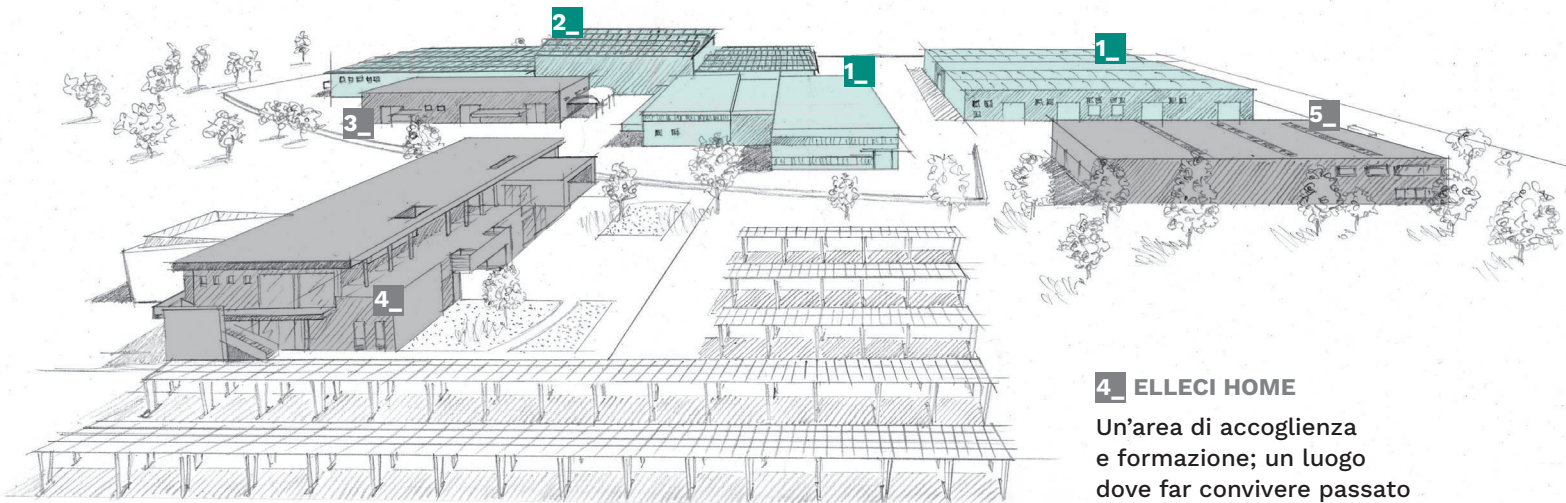

4_ ELLECI HOME

Un'area di accoglienza e formazione; un luogo dove far convivere passato e visioni future. Un'esperienza completa del Mondo Elleci.

2 HUB PRODUTTIVI DIFFERENZIATI

100.000 M2
PRODUTTIVI DIFFERENZIATI
50.000 M2 AREA OPERATIVA COPERTA

2,3 MW
DI ENERGIA PRODOTTA
DA FONTI RINNOVABILI
~50% FABBISOGNO ENERGETICO COMPLESSIVO

3_ INNOVATION CENTER

Uno stabilimento dedicato alla ricerca e sviluppo dove le idee più ambiziose prendono forma.

5_ ELLECI SERVICE

Valore e cura delle relazioni: questo spazio è completamente indirizzato a rafforzare il rapporto di fiducia con i clienti nelle fasi di pre e post vendita.

MATERIALS

KERATEK[®]
CERAMIC NANOTECHNOLOGY CN6

DOES MATTER

Colori vividi, profondi e intensi che catturano lo sguardo a prima vista. Una superficie ultra liscia e sorprendentemente compatta crea un effetto seta al primo contatto.

Keratek, un materiale innovativo nato per sorprendere; una formulazione unica garantisce bellezza

e performance in termini di durevolezza, alta resistenza agli shock termici ed agli urti. Certificato NSF, è adatto al contatto con i cibi. Affascinante, igienico e facile da pulire, **è un materiale che conta, in ogni sua micro-particella.**

*

20 ANNI · YEARS
WARRANTY
GARANTITO



*

I lavelli hanno garanzia legale di 24 mesi. Solo effettuando la registrazione si può godere della garanzia convenzionale.

SUPERFICIE **SILK EFFECT**

DENSA, LISCIA E SETOSA AL TATTO, CONIUGA ALLA PERFEZIONE FUNZIONALITÀ ED ESTETICA.



FEATURES



SILKY
SMOOTH
FINISH



EASY
TO
CLEAN



DIRT
REPELLENT
EFFECT



INTENSE
COLOURS

IMPROVEMENTS *



HIGH
SCRATCH
RESISTANT



HOT WATER
RESISTANT

K96 White

K93 Dove Grey

K97 Light Grey

K99 Dark Grey

K95 Champagne

K86 Black

MATERIALS

GRANITEK®

NATURAL GRANITE EFFECT

ENGINEERED QUARTZ

La materia a portata di mano. Nato dalla volontà di sfruttare in cucina la natura più tecnologica del quarzo è sostanza dall'aspetto importante.

Ultramaterica al tatto, resistente ai cambiamenti di temperatura e agli urti, è stata creata per durare nel tempo.

Grazie alla vasta gamma colori, suddivisa in tre differenti finiture, nessun dettaglio sarà trascurato, né al tatto né alla vista:

Metal:

La più chic. Grazie a tantissime particelle metalliche, la superficie sarà lucente, brillante e scintillante.

Matt:

Elegante e discreta. Una finitura raffinata, ideale per essere inserita in contesti moderni.

Classic:

La finitura dallo stile che non passa mai di moda. Un effetto pietra naturale, esaltato da texture cromatiche, perfette in ogni dettaglio.

*

10 ANNI · YEARS
WARRANTY
GARANTITO



SUPERFICIE **NATURAL QUARTZ**

UNA FORMULAZIONE DALLA SUPERFICIE MATERICA
INGEGNERISTICAMENTE STUDIATA PER ESALTARE
LE MIGLIORI QUALITÀ DEL QUARZO.



*

I lavelli hanno garanzia legale di 24 mesi. Solo effettuando la registrazione si può godere della garanzia convenzionale.

FEATURES



NATURAL
QUARTZ
FINISH



IMPACT
RESISTANT



THERMAL
SHOCK
RESISTANT



MADE
TO
LAST

IMPROVEMENTS



NEW
DEEP
BLACK

METAL

M79 Aluminium

M73 Titanium

MATT

G68 Bianco

G48 Cemento

G43 Tortora

G78 Espresso

G40 Nero

CLASSIC

G62 Bianco Antico

G51 Avena

G59 Antracite

CHOICES THAT MATTER

PERFECT INSTALLATION

CHOOSE A COLOR *



APPOGGIO



SOPRATOP

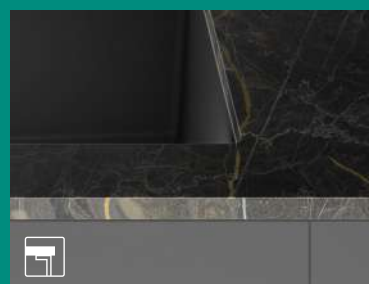

SOTTOTOP



FILOTOP

Elleci propone quattro modalità di installazione toccando più generi stilistici: partendo dall'installazione in Appoggio, tipica delle cucine dallo stile Farmhouse, passando per la tipica installazione Sopratop, sino ad arrivare alle installazioni dall'aspetto più contemporaneo come la Sottotop e la Filotop.

ADD IDEAL MIXER[◇]



La scelta del miscelatore è importante per un'estetica integrata alle funzionalità del lavello e allo stile del resto della cucina; per questo Elleci propone due diversi tipi di abbinamento prodotti in modo da creare coerenza e uniformità:

METAL FINISHINGS E FAMILY LINE [◇]

Mixers dalle finiture eleganti e raffinate, nati per sposarsi con i dettagli degli elettrodomestici Elleci.

FULL COLOR E CONTINUITÀ *

Mixers verniciati in ogni parte e componente del colore del lavello per un abbinamento perfetto e una sensazione di continuità totale.



CHOOSE YOUR ACCESSORIES 3 LEVELS, MANY POSSIBILITIES.



Per un'ulteriore personalizzazione delle funzionalità lavello ed aggiungere valore alla workstation, una vasta gamma di accessori renderà ancora più piacevole l'esperienza in area preparazione.

Gli accessori si possono distribuire fino a **tre diversi piani di appoggio**, ottimizzando ogni livello-vasca del lavello per un utilizzo combinato.



PERSONALIZE IT...

DESIGN, IGIENE E DUREVOLEZZA.

Il tagliere in HPL (Laminato ad Alta Pressione) di Elleci è l'aggiunta speciale al lavello cucina. Estremamente robusto, resistente a graffi, urti e abrasioni, si caratterizza da una superficie non porosa che facilita la pulizia garantendo la massima igiene in cucina. È disponibile nelle colorazioni Nero, Grigio, Quercia, Olmo e Wood.



FLOW PRO OPEN UP



OPEN UP

COMANDO REMOTO
AUTOMATICO DISPONIBILE
SU RICHIESTA IN VERSIONE KIT.

L'eccellenza risiede nei più piccoli dettagli. Con la massima attenzione alla funzionalità ed al design del prodotto, il sistema di scarico cambia aspetto. La piletta dallo stile ricercato garantisce una continuità estetica all'interno della vasca mentre l'ergonomia del comando centrale ne favorisce l'utilizzo.



FLOW PRO

Cambia il concetto di piletta in un sistema di scarico moderno, pratico e semplice nell'utilizzo e nella manutenzione.



Sistema di scarico Flow Pro in versione Black Matt.



Sistema di scarico Flow Pro in versione Oro spazzolato.

OPEN UP



Open Up è il comodo ed elegante comando remoto per pilette che ne consente l'apertura e la chiusura automatica attraverso un semplice azionamento a pressione, senza dover immergere la mano nella vasca.



EVERY DAY USE

Dal risveglio alla sera, la workstation è la compagnia ideale per ogni momento della giornata.

Dopo anni di ricerca applicata all'uso del vivere la cucina, nasce un'area preparazione che sorprende ad ogni nuovo gesto. Accessori integrati alla postazione ottimizzano ogni movimento e riducono al minimo l'ingombro sul top cucina. Colazione, brunch, merende, aperitivi e cene: la preparazione all-in, dal taglio alla degustazione.



VASCHETTA COLANDER

L'accessorio ideale per organizzare e scolare.





MISCELATORE WAVE CROMO

Il mixer brillante nell'estetica e nelle funzionalità. Caratterizzato da un elegante design bicolore, si compone di un'alta canna girevole ergonomica in silicone nero matt, con doccetta estraibile in grado di raggiungere facilmente tutti gli angoli vasca.



TAGLIERE ELEMENT BLACK

Il tagliere multifunzione dotato di pratiche scanalature per un uso integrato al lavello o in appoggio su top cucina.



EVERY DAY USE

BREAKFAST



Mani nell'impasto, uova rotte e una buona dose di dolcezza per una ricetta gustosissima.

Il nuovo modello **Spazio 900** è caratterizzato da linee pulite e dalla vasca XL, profonda e capiente, in grado di ospitare anche le pentole e le teglie da forno più grandi.

lavello_Spazio 900 K96 Bianco
miscelatore_Arcadia Cromato

Il design farm house rivisitato in chiave contemporanea,
 si adatta sia ad ambienti moderni che classici e, grazie
 alla generosa capienza della vasca ed ai taglieri multifunzione,
 l'area preparazione diventa una workstation a tutti gli effetti.



EVERY DAY USE

LUNCH



lavello_Life 480 G78 Espresso
miscelatore_Trail G78 Espresso





Il momento della giornata dedicato al piacere del ritrovo familiare e della condivisione.

Life 480 è il perfetto alleato ed entra nella famiglia Elleci con un design concreto, essenziale e moderno. Attraverso forme e linee discrete, un ampio gocciolatoio ed un set di accessori come taglieri multiuso, è ottimo per l'uso quotidiano in quanto soddisfa ogni necessità in famiglia.

EVERY
DAY USE

HAPPY HOUR



lavello inox_Compass 700
 miscelatore_Flux Cromato
 piano cottura a induzione_Urban 60



**Spazio alla socialità,
 è tempo di rilassarsi e bere
 un buon cocktail con gli amici.**

Varie preparazioni e tante mini ricette trovano il giusto alleato in cucina; il lavello inox **Compass** con una vasca di grandi dimensioni, un set di accessori multifunzione abbinato all'innovativo miscelatore Flux con doccetta estraibile renderà tutto più semplice e veloce.

EVERY DAY USE

DINNER



**Momento introspettivo e generoso,
elegante e conviviale in cui tirare le somme
della giornata trascorsa di fronte
ad un buon piatto, perchè no, anche gourmet!**

Come una vera postazione professionale,
la workstation essenziale **Best 105** è ideale
anche per fasi di preparazione articolate.

lavello in composito_Best 105 K86 Black
miscelatore_Hype Black Matt
piano cottura a induzione_Urban 80



WHAT'S **NEW**

NUOVI LAVELLI

**UNA COLLEZIONE
DI LAVELLI COMPLETA
E DIVERSIFICATA
NELL'ESTETICA
E NELLA FUNZIONALITÀ,
SI ARRICCHISCE DI TRE
NUOVI MODELLI.**

Spazio 900, caratterizzato dall'ampia vasca e dallo stile più tradizionale, rivoluziona l'estetica farmhouse, rendendola fresca e attuale.

Segue la workstation **Best 105**, una soluzione estremamente ergonomica e dall'animo essenziale. Si compone di una profonda vasca singola con suddivisione a tre livelli e bordo salvagoccia che permette lo scorrimento degli accessori lungo tutto il lavello.

Perfetta anche per gli ambienti più ristretti, troviamo infine **Life 410**, il lavello lineare in cui lo stile classico abbraccia la modernità attraverso forme e linee discrete.

Cucina contemporanea
lavello_Best 105 K86 Black
miscelatore_Hype Black Matt

Ambiente Farmhouse
lavello_Spazio 900 K96 White in appoggio
miscelatore_Arcadia Black Matt

Cucina lineare ad angolo
lavello_Life 480 G78 Espresso
miscelatore_Trail G78 Espresso





WHAT'S **NEW**

NUOVE FINITURE

Le nuove finiture dalle cromie lucenti esaltano le forme estetiche dei miscelatori e della componentistica, impreziosendo ogni loro dettaglio. Le nuove finiture **Black Matt, Cromo, Cromo spazzolato ed Oro spazzolato**, sono nate per donare un aspetto moderno ed affascinante al piano lavoro.





WHAT'S **NEW**

NUOVI MISCELATORI





**E DOPO L'ABITO
È GIUSTO CAMBIARE
ANCHE LA SOSTANZA.**

Club, Hype, Kent e Arcadia
le quattro nuove forme inedite
dall'animo contemporaneo
per un'area di preparazione
seducente ed un protagonismo
discreto e raffinato.

Sulla sinistra miscelatore Arcadia Black Matt | Club Cromato Spazzolato

Sopra miscelatore Kent Oro spazzolato | Miscelatore Hype Black Matt

WHAT'S **NEW**

TOTAL GLASS_ **BLACK IS BACK** FOR UNLIMITED **MATCHING**

Il mondo Elleci si compone di forni, piani cottura, accessori, miscelatori e complementi in grado di coordinarsi perfettamente con i colori dei lavelli in composito, dando vita ad una Family Line cromatica che genera armonia nell'area preparing.

lavello in composito_Zen 130 K86 Black
miscelatore_Kent Black Matt
microonde_Urban
forno_Urban Plus
induzione_Urban 80

LA LINEA TOTAL GLASS SI TINGE DI NERO.

Il vetro è un materiale moderno e raffinato ed entra in gioco quando si parla di elettrodomestici dallo stile contemporaneo. Una linea ampia, composta di forni, microonde, piani cottura gas on glass e a induzione, si riveste di superfici in vetro estremamente lisce che impreziosiscono la base nera con giochi di luce dall'effetto brillante.

ANCHE LA BLACK FAMILY LINE SCEGLIE DI SCHIERARSI IN CUCINA CON IL COLORE NERO PER VESTIRSI DI INTRAMONTABILE ELEGANZA.

Ogni dettaglio è pensato per integrarsi in total look agli altri elementi, come le finiture di componenti ed accessori per un nero totale delicato alla vista e al tatto.



lavello in composito_Best 130 K86 Black
miscelatore_Arcadia Black Matt
piano cottura_Urban Gas on Glass 90

CARE FOR ATTENTION



SUPPORTO E ASSISTENZA

Costantemente impegnata nell'offrire ai propri clienti un servizio efficiente e professionale, il progetto di **Customer Care di Elleci** si proietta sulle relazioni e sul valore di queste ultime.

È con questi presupposti che nasce **Elleci Service**: una possibilità concreta per costruire un rapporto con i clienti ed aumentare l'esperienza di acquisto nonché la soddisfazione attraverso un servizio di risposta tempestivo e qualificato dal pre vendita al post vendita.



SCOPRI
LA PAGINA
DEDICATA
AL SUPPORTO
E ASSISTENZA



WEBSITE
www.elleci.com/it



CHIAMACI AL NUMERO VERDE
800.800.803

REGISTRAZIONE

REGISTRARE IL LAVELLO ELLECI SUL SITO, CONVIENE!

Basterà scannerizzare il QR code al lato e compilare l'anagrafica. Durante questa fase verranno richiesti i dati del prodotto, occorrerà solamente tenerli accanto durante tutta la fase di registrazione.



INQUADRA QUI
CON IL TUO
SMARTPHONE

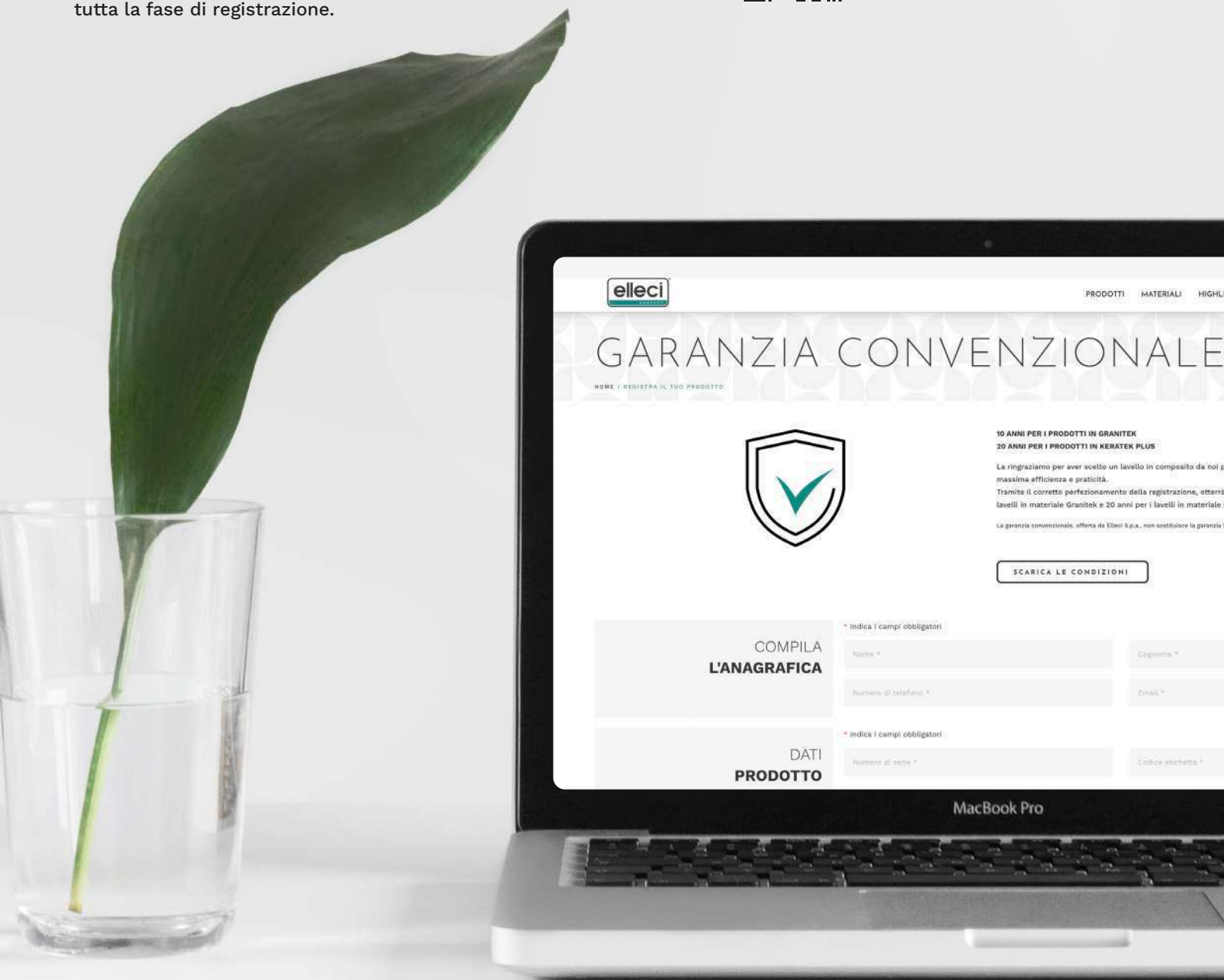

GARANZIA CONVENZIONALE*

10 ANNI DI GARANZIA PER I LAVELLI IN **GRANITEK**

20 ANNI DI GARANZIA PER I LAVELLI IN **KERATEK**

In seguito all'acquisto di un lavello Elleci ed alla fase di registrazione di quest'ultimo, si otterrà l'estensione della garanzia a 10 anni per i lavelli in materiale Granitek e 20 anni per i lavelli in materiale Keratek.

INDICE COLLEZIONI LAVELLI

NEW

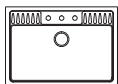

SPAZIO 900
PAG. 46

NEW

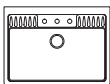

SPAZIO EXTRA
PAG. 46

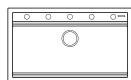

BEST 360
PAG. 50

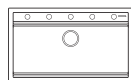

BEST 360 BUNDLE
PAG. 50

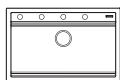

BEST 130
PAG. 51

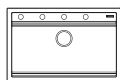

BEST 130 BUNDLE
PAG. 51

NEW



BEST 105
PAG. 52

NEW



BEST 104
PAG. 52

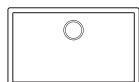

ZEN/ZEN F 130
PAG. 56-60

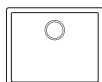

ZEN/ZEN F 105
PAG. 56-60



ZEN/ZEN F 102
PAG. 57-61

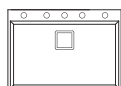

KARISMA 120
SOPRATOP
PAG. 64

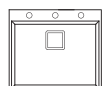

KARISMA 105
SOPRATOP
PAG. 64

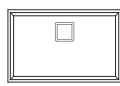

KARISMA 120
SOTTOTOP
PAG. 65



KARISMA 105
SOTTOTOP
PAG. 65

NEW

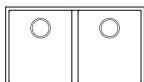

INTEGRA 350
PAG. 68

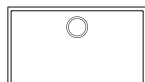

INTEGRA 130
PAG. 68

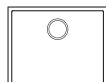

INTEGRA 105
PAG. 69



INTEGRA 102
PAG. 69

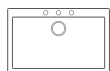

QUADRA 130
SOPRATOP
PAG. 72



QUADRA 110
SOPRATOP
PAG. 72



QUADRA 105
SOPRATOP
PAG. 73



QUADRA 102
SOPRATOP
PAG. 73



QUADRA 100
SOPRATOP
PAG. 74



QUADRA 50
SOPRATOP
PAG. 74

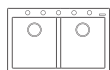

QUADRA 350
SOPRATOP
PAG. 75

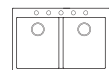

QUADRA 340
SOPRATOP
PAG. 75

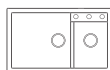

QUADRA 440
SOPRATOP
PAG. 76



QUADRA 150
SOPRATOP
PAG. 76

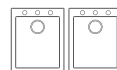

QUADRA 200
SOPRATOP
PAG. 77

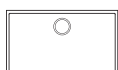

QUADRA 130
SOTTOTOP
PAG. 80



QUADRA 110
SOTTOTOP
PAG. 80



QUADRA 105
SOTTOTOP
PAG. 81



QUADRA 102
SOTTOTOP
PAG. 81



QUADRA 100
SOTTOTOP
PAG. 82



QUADRA 50
SOTTOTOP
PAG. 82

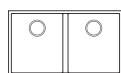

QUADRA 350
SOTTOTOP
PAG. 83

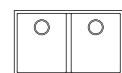

QUADRA 340
SOTTOTOP
PAG. 83

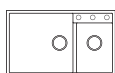

QUADRA 440
SOTTOTOP
PAG. 84



QUADRA 150
SOTTOTOP
PAG. 84

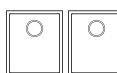

QUADRA 200
SOTTOTOP
PAG. 85

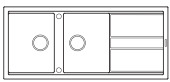

BEST 500
PAG. 88

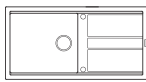

BEST 480
PAG. 88

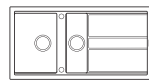

BEST 475
PAG. 89

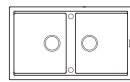

BEST 450
PAG. 89

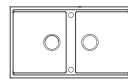

BEST 450
SOTTOTOP
PAG. 90

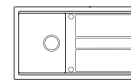

BEST 400
PAG. 90

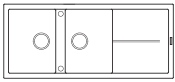

UNICO 500
PAG. 94

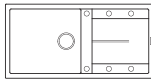

UNICO 480
PAG. 94

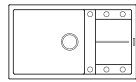

UNICO 410
PAG. 95

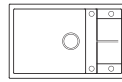

UNICO 310
PAG. 95

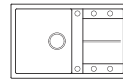

UNICO 300
PAG. 96

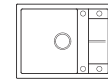

UNICO 125
PAG. 96

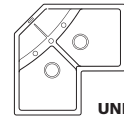

UNICO CORNER
PAG. 97

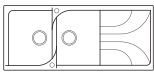

EGO 500
PAG. 100

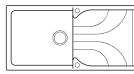

EGO 480
PAG. 100

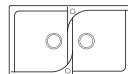

EGO 450
PAG. 101

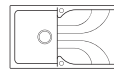

EGO 400
PAG. 101



EGO ROUND
PAG. 102

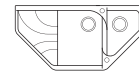

EGO ESA
PAG. 102

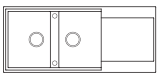

EASY 500
PAG. 106

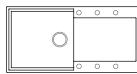

EASY 480
PAG. 106

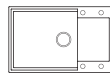

EASY 310
PAG. 107

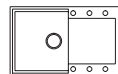

EASY 300
PAG. 107

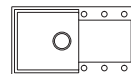

EASY 290
PAG. 108



EASY 135
PAG. 108

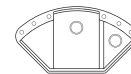

EASY CORNER
PAG. 109



EASY ROUND 60
PAG. 109

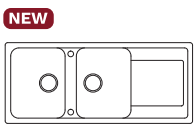

NEW

LIFE 500
PAG. 112

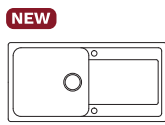

NEW

LIFE 480
PAG. 112

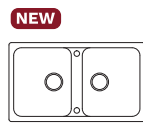

NEW

LIFE 450
PAG. 113

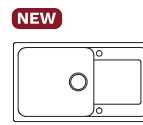

NEW

LIFE 410
PAG. 113

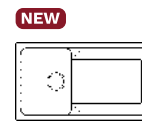

NEW

LIFE 400
PAG. 114

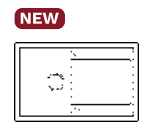

NEW

LIFE 300
PAG. 114

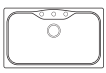

FOX 360
PAG. 118



FOX 200
PAG. 118



FOX 180
PAG. 119



FOX ROUND
PAG. 119

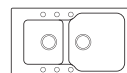

FOX 430
PAG. 120

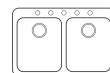

FOX 340
PAG. 120

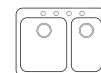

FOX 330
PAG. 121

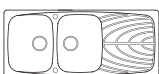

MASTER 500
PAG. 124

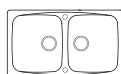

MASTER 450
PAG. 124

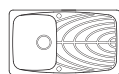

MASTER 400
PAG. 125

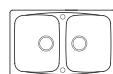

MASTER 350
PAG. 125

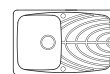

MASTER 300
PAG. 126

INDICE COLLEZIONI LAVELLI INOX

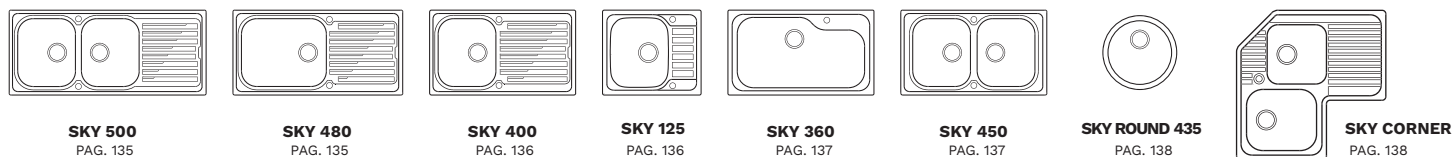
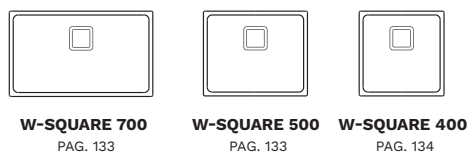
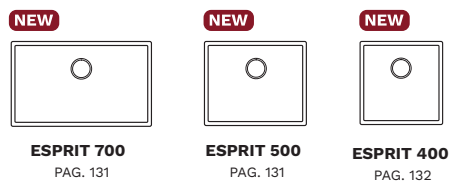
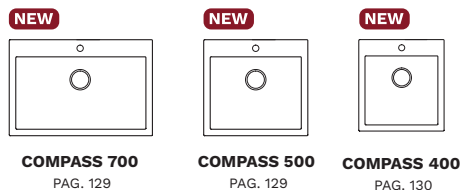

INDICE COLLEZIONI ACCESSORI

ACCESSORI ELEMENT

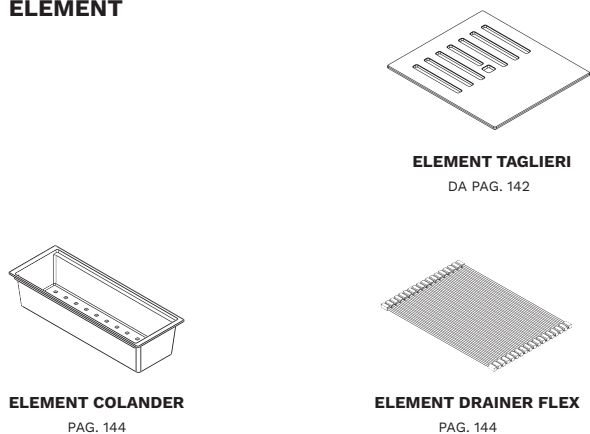

OPTIONAL

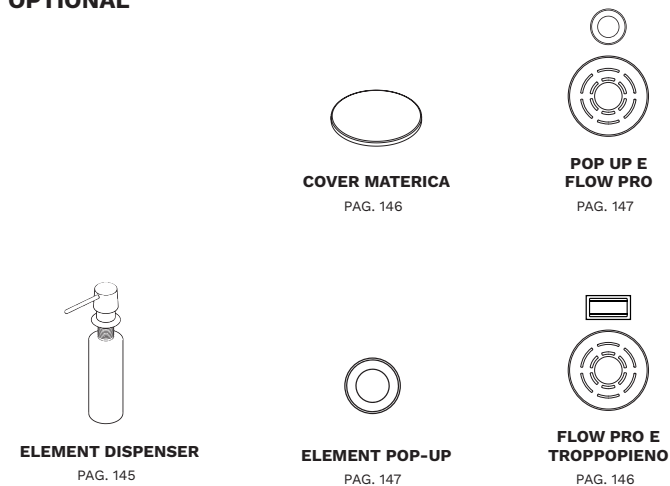

ACCESSORI VARI



INDICE MISCELATORI

PROFESSIONAL

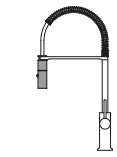

NEW **ARCADIA**
PAG. 154

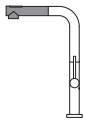

FLUX
PAG. 155

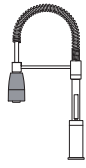

CHEF
PAG. 156

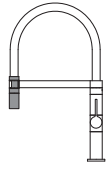

WAVE
PAG. 154

CANNA L

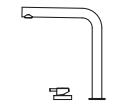

NEW **KENT**
PAG. 155

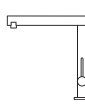

TEMA
PAG. 156

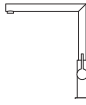

ARES
PAG. 157

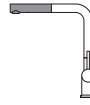

STREAM PLUS
PAG. 158

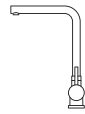

DANUBIO
PAG. 165

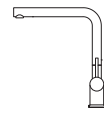

STREAM
PAG. 158

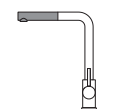

TRAIL PLUS
PAG. 159

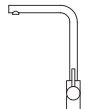

TRAIL
PAG. 159

FILTRANTE

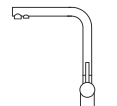

TOURMALINE
PAG. 160

CANNA A PONTE

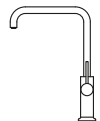

NEW **HYPE**
PAG. 157

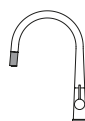

NEW **ATHENA PLUS**
PAG. 161

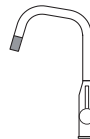

DORA PLUS
PAG. 162

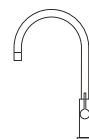

VOLTA
PAG. 164

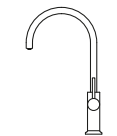

NEW **CLUB**
PAG. 163

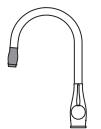

NEVA
PAG. 165

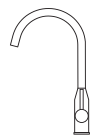

ADIGE
PAG. 162



ATHENA
PAG. 161



BRIDGE
PAG. 163



CLOUD
PAG. 164

TRADITIONAL

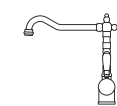

RIO
PAG. 169

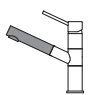

RENO
PAG. 166



SENNA
PAG. 167



SAVA
PAG. 166

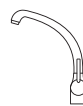

PO
PAG. 167



VENERE
PAG. 168



MINERVA
PAG. 168

INDICE COLLEZIONI PIANI COTTURA

NEW

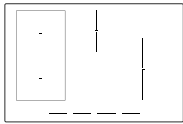

**URBAN
INDUCTION 80**
PAG. 172

NEW

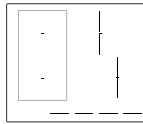

**URBAN
INDUCTION 60**
PAG. 173

NEW

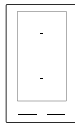

**URBAN
INDUCTION 30**
PAG. 173

NEW

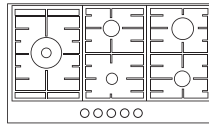

**URBAN
GAS ON GLASS 90**
PAG. 174

NEW

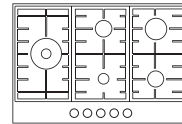

**URBAN
GAS ON GLASS 75**
PAG. 175

NEW

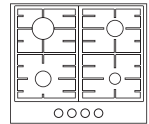

**URBAN
GAS ON GLASS 60**
PAG. 175

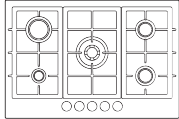

PLANO PLUS 75
PAG. 176

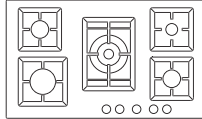

PLANO 90
PAG. 178

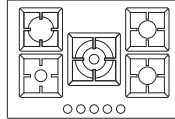

PLANO 75
PAG. 180

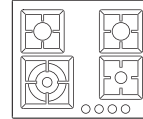

PLANO 60
PAG. 181

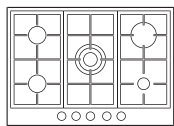

STYLE 75
PAG. 182

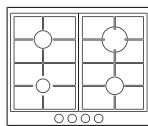

STYLE 60
PAG. 183

NEW

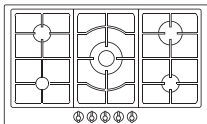

COUNTRY 90
PAG. 184

NEW

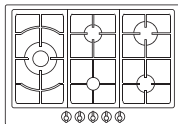

COUNTRY 75
PAG. 185

INDICE COLLEZIONI FORNI

NEW

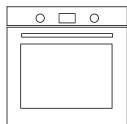

URBAN PLUS
PAG. 186

NEW

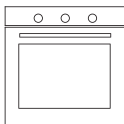

URBAN
PAG. 187

NEW

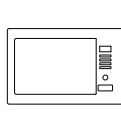

URBAN MICROONDE
PAG. 187

NEW



PLANO PLUS
PAG. 188

NEW

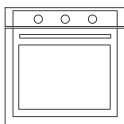

PLANO
PAG. 190

NEW

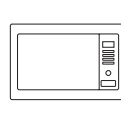

PLANO MICROONDE
PAG. 192

NEW

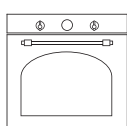

COUNTRY
PAG. 194

INDICE COLLEZIONI CAPPE

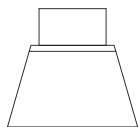

BRIO
PAG. 197



URBAN
PAG. 197

INDICE COLLEZIONI DISSIPATORI



MODELLO 1000 TOP
PAG. 199



MODELLO 750 TOP
PAG. 199



MODELLO 750
PAG. 199

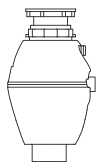

MODELLO 500 TOP
PAG. 199

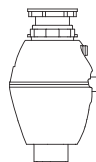

MODELLO 500
PAG. 199



MAGGIORI
INFORMAZIONI
LINEA SPAZIO



IL FARMHOUSE MODERNO

Le geometrie dello Spazio permettono di sfruttare al massimo il volume della vasca extralarge in modo intelligente ed estremamente razionale. Il bordo interno che permette lo scorrimento degli accessori costituisce un'esperienza di utilizzo estremamente confortevole nelle fasi di Preparing e Cleaning.

red dot winner 2023



PLUS SPAZIO



ACCESSORI
ELEMENT



FLOW PRO



VASCA XL

KERATEK[®]
CERAMIC NANOTECHNOLOGY CN6

-  **Black**
K86
-  **Dove Grey**
K93
-  **Champagne**
K95
-  **White**
K96
-  **Light Grey**
K97
-  **Dark Grey**
K99

I MODELLI SPAZIO

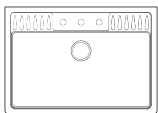

SPAZIO **900**

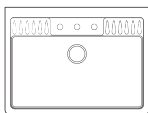

SPAZIO **900 EXTRA**

Corredo del lavello: Sifone salvaspazio, piletta Flow Pro integrata, troppopieno rettangolare e ganci.

ACCESSORI CONSIGLIATI

193

**ELEMENT
TAGLIERE SPAZIO**
ATH123WD
Pag. **142**



Finiture



Black Wood

IL PERFETTO MATCH MISCELATORI



ARCADIA - Black BK
MOKARCBK

Pag. **154**

Disponibile nelle colorazioni

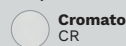

Cromato
CR



Black
BK

OPTIONAL

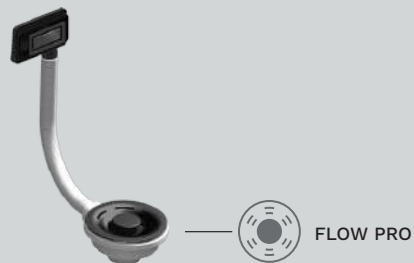

KIT ELEMENT
FLOW PRO + TROPPO PIENO BLACK
KITWPT-F-1VSLL-BK

Pag. **146**

elleci | BEAUTY



Una linea di prodotti appositamente studiata per la cura dei lavelli in composito.

Scopri di più a pag. **200**

*Per ulteriori informazioni vai alla sezione accessori a pag. **140**

SPAZIO 900 NEW



White
K96

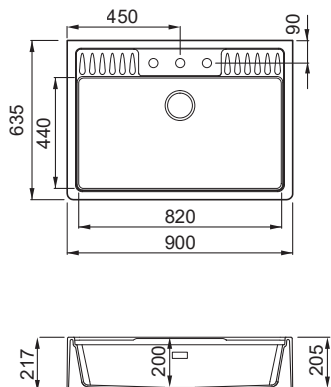

OPTIONAL



Pag. 146

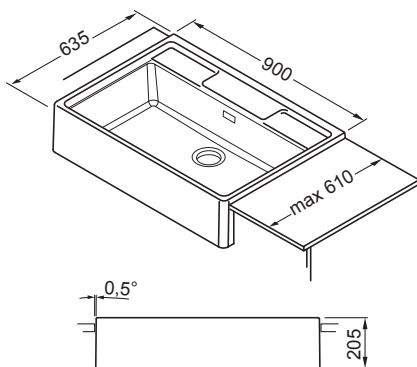

MATERIALI E COLORI

KERATEK CERAMIC NANOTECHNOLOGY DNR		Euro 1200
	Black K86	LKS90086
	Dove Grey K93	LKS90093
	Champagne K95	LKS90095
	White K96	LKS90096
	Light Grey K97	LKS90097
	Dark Grey K99	LKS90099

Lavello 1 vasca

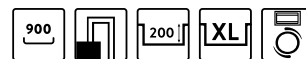

CARATTERISTICHE

Dimensioni (mm)	900 x 635
Base (mm)	900
Foro da incasso (mm)	Da dima*
Profondità Vasca (mm)	200
Installazione	Appoggio
Orientamento	Non reversibile

ACCESSORI CONSIGLIATI

193

*dima inclusa nella confezione o scaricabile dalla sezione download specifica del sito www.elleci.com/it

SPAZIO 900 EXTRA NEW



White
K96

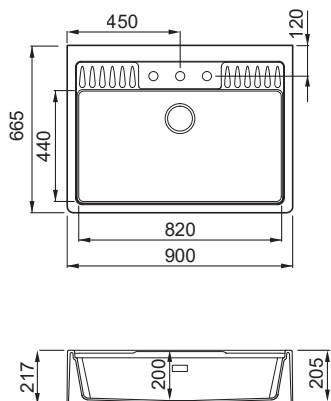

OPTIONAL



Pag. 146

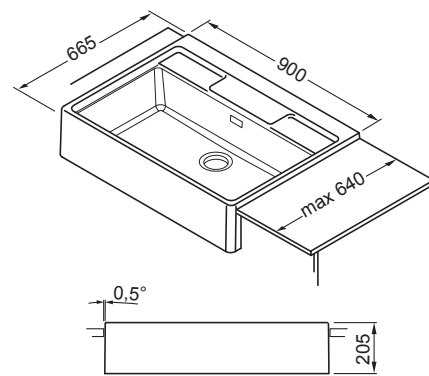

MATERIALI E COLORI

KERATEK CERAMIC NANOTECHNOLOGY DNR		Euro 1200
	Black K86	LKS90086XLP
	Dove Grey K93	LKS90093XLP
	Champagne K95	LKS90095XLP
	White K96	LKS90096XLP
	Light Grey K97	LKS90097XLP
	Dark Grey K99	LKS90099XLP

Lavello 1 vasca

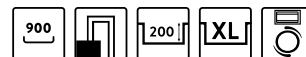

CARATTERISTICHE

Dimensioni (mm)	900 x 665
Base (mm)	900
Foro da incasso (mm)	Da dima*
Profondità Vasca (mm)	200
Installazione	Appoggio
Orientamento	Non reversibile

ACCESSORI CONSIGLIATI

193

*dima inclusa nella confezione o scaricabile dalla sezione download specifica del sito www.elleci.com/it



COLLEZIONE
BEST WORKSTATION



MAGGIORI
INFORMAZIONI
LINEA BEST WORKSTATION



LA WORKSTATION PER ECCELLENZA

Una cucina ben organizzata è un'ottima base di partenza per realizzare ogni ricetta: la Best Workstation si compone di una vasca XL e di una serie di accessori progettati appositamente per avere tutto a portata di mano. Il colander in polipropilene, il drainer flex in silicone, il tagliere in HPL, il pop-up control rendono tutto più semplice e realizzabile.

PLUS **BEST
WORKSTATION**



ACCESSORI
ELEMENT



FLOW PRO



3 LIVELLI

GRANITEK
NATURAL GRANITE EFFECT

- Titanium**
M73
- Aluminium**
M79
- Nero**
G40
- Tortora**
G43
- Cemento**
G48
- Bianco**
G68
- Espresso**
G78

- Avena**
G51
- Antracite**
G59
- Bianco Antico**
G62

KERATEK
CERAMIC NANOTECHNOLOGY CN6

- Black**
K86
- Dove Grey**
K93
- Champagne**
K95
- White**
K96
- Light Grey**
K97
- Dark Grey**
K99

I MODELLI BEST WORKSTATION

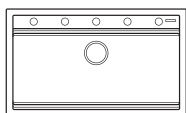

BEST **360**

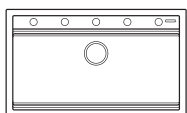

BEST **360 BUNDLE**

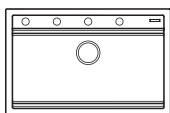

BEST **130**

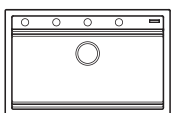

BEST **130 BUNDLE**

Corredo del lavello: Sifone salvaspazio, piletta Flow Pro integrata, troppopieno rettangolare e ganci.

Corredo del lavello Bundle: Colander, Drainer Flex, sifone salvaspazio, piletta Flow Pro integrata, troppopieno integrato e ganci.

ACCESSORI CONSIGLIATI

93

**ELEMENT TAGLIERE
BEST WORKSTATION**
ATH073QU
Pag. **143**



Finiture

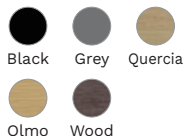

156

**ELEMENT DRAINER
FLEX 500**
ARS023BK
Pag. **144**



Finiture



153

**ELEMENT COLANDER
BEST WORKSTATION**
AVP034BK
Pag. **144**



Finiture



97

**ELEMENT POP-UP
PUSH CONTROL**
ASP13002BK
Pag. **147**



Finiture



*Per ulteriori informazioni vai alla sezione accessori a pag. **140**

IL PERFETTO MATCH MISCELATORI



WAVE - Black BK
MOKWAVBK

Pag. **154**

Disponibile nelle colorazioni



OPTIONAL

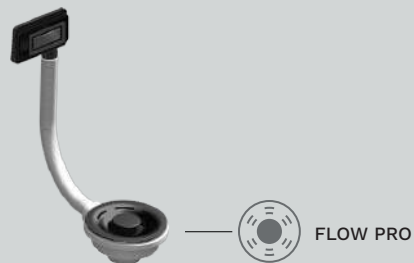

KIT ELEMENT
FLOW PRO + TROPPO PIENO BLACK
KITWPT-F-1VSL-L-BK

Pag. **146**

elleci | BEAUTY



Una linea di prodotti appositamente studiata per la cura dei lavelli in composito.

Scopri di più a pag. **200**

BEST 360



White
K96

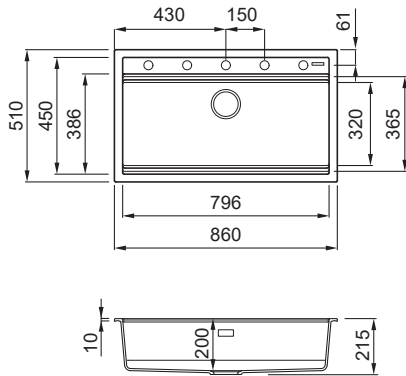

OPTIONAL



Pag. 146

Lavello 1 vasca



CARATTERISTICHE

Dimensioni (mm)	860 x 510
Base (mm)	900
Foro da incasso (mm)	840 x 480
Profondità Vasca (mm)	200
Installazione	Sopratop
Orientamento	Non reversibile

ACCESSORI CONSIGLIATI

93	97	25	50	153	156	163
164	5	75	71	9		

MATERIALI E COLORI

KERATEK GERMIC NANOTECHNOLOGY DNR	Euro 698
Black K86	LKB36086
Dove Grey K93	LKB36093
Champagne K95	LKB36095
White K96	LKB36096
Light Grey K97	LKB36097
Dark Grey K99	LKB36099

GRANITEK NATURAL GRANITE EFFECT	Euro 546
METAL	
Titanium M73	LMB36073
Aluminium M79	LMB36079

	Euro 524
MATT	
Nero G40	LGB36040
Tortora G43	LGB36043
Cemento G48	LGB36048
Bianco G68	LGB36068
Espresso G78	LGB36078

	Euro 524
CLASSIC	
Avena G51	LGB36051
Antracite G59	LGB36059
Bianco Antico G62	LGB36062

BEST 360 BUNDLE



White
K96

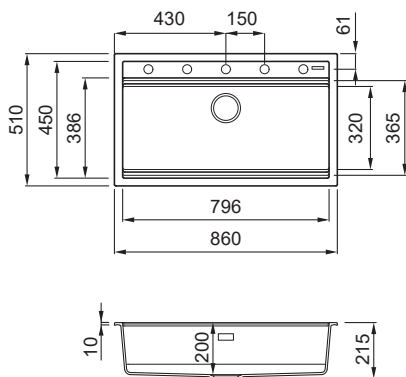

Lavello 1 vasca con Flex Drainer e colander inclusi



CARATTERISTICHE

Dimensioni (mm)	860 x 510
Base (mm)	900
Foro da incasso (mm)	840 x 480
Profondità Vasca (mm)	200
Installazione	Sopratop
Orientamento	Non reversibile

ACCESSORI CONSIGLIATI

93	97	25	50	163	164	5
75	71	9				

MATERIALI E COLORI

KERATEK GERMIC NANOTECHNOLOGY DNR	Euro 828
Black K86	LKB36086K2
Dove Grey K93	LKB36093K2
Champagne K95	LKB36095K2
White K96	LKB36096K2
Light Grey K97	LKB36097K2
Dark Grey K99	LKB36099K2

GRANITEK NATURAL GRANITE EFFECT	Euro 681
METAL	
Titanium M73	LMB36073K2
Aluminium M79	LMB36079K2

	Euro 657
MATT	
Nero G40	LGB36040K2
Tortora G43	LGB36043K2
Cemento G48	LGB36048K2
Bianco G68	LGB36068K2
Espresso G78	LGB36078K2

	Euro 657
CLASSIC	
Avena G51	LGB36051K2
Antracite G59	LGB36059K2
Bianco Antico G62	LGB36062K2

BEST 130



Light Grey
K97

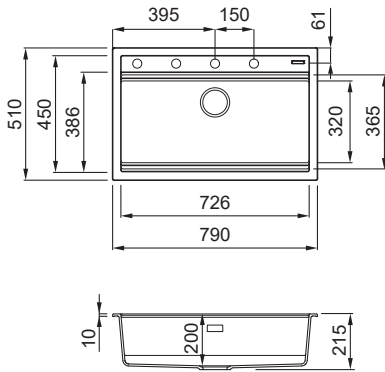

OPTIONAL



Pag. 146

Lavello 1 vasca



CARATTERISTICHE

Dimensioni (mm) **790 x 510**
 Base (mm) **800**
 Foro da incasso (mm) **770 x 480**
 Profondità Vasca (mm) **200**
 Installazione **Sopratop**
 Orientamento **Non reversibile**

ACCESSORI CONSIGLIATI

93	97	25	50	153	156	163
164	5	75	71	9		

MATERIALI E COLORI

KERATEX GERAM: NANOTECHNOLOGY ONE	Euro 698
● Black K86	LKB13086
● Dove Grey K93	LKB13093
● Champagne K95	LKB13095
● White K96	LKB13096
● Light Grey K97	LKB13097
● Dark Grey K99	LKB13099

GRANITEX NATURAL GRANITE EFFECT	Euro 546
METAL	
● Titanium M73	LMB13073
● Aluminium M79	LMB13079

MATT	Euro 524
● Nero G40	LGB13040
● Tortora G43	LGB13043
● Cemento G48	LGB13048
● Bianco G68	LGB13068
● Espresso G78	LGB13078

CLASSIC	Euro 524
● Avena G51	LGB13051
● Antracite G59	LGB13059
● Bianco Antico G62	LGB13062

BEST 130 BUNDLE



Light Grey
K97

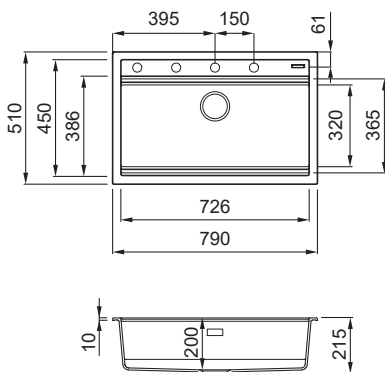

Lavello 1 vasca con Flex Drainer e colander inclusi



CARATTERISTICHE

Dimensioni (mm) **790 x 510**
 Base (mm) **800**
 Foro da incasso (mm) **770 x 480**
 Profondità Vasca (mm) **200**
 Installazione **Sopratop**
 Orientamento **Non reversibile**

ACCESSORI CONSIGLIATI

93	97	25	50	163	164	5
75	71	9				

MATERIALI E COLORI

KERATEX GERAM: NANOTECHNOLOGY ONE	Euro 828
● Black K86	LKB13086K2
● Dove Grey K93	LKB13093K2
● Champagne K95	LKB13095K2
● White K96	LKB13096K2
● Light Grey K97	LKB13097K2
● Dark Grey K99	LKB13099K2

GRANITEX NATURAL GRANITE EFFECT	Euro 681
METAL	
● Titanium M73	LMB13073K2
● Aluminium M79	LMB13079K2

MATT	Euro 657
● Nero G40	LGB13040K2
● Tortora G43	LGB13043K2
● Cemento G48	LGB13048K2
● Bianco G68	LGB13068K2
● Espresso G78	LGB13078K2

CLASSIC	Euro 657
● Avena G51	LGB13051K2
● Antracite G59	LGB13059K2
● Bianco Antico G62	LGB13062K2

BEST 105 NEW



Black
K86

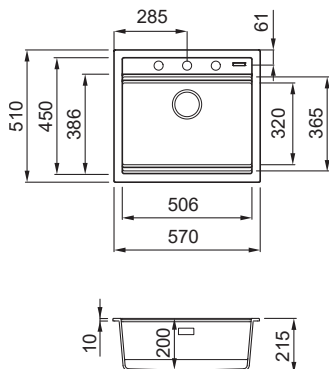

Lavello 1 vasca



CARATTERISTICHE

Dimensioni (mm)	570 x 510
Base (mm)	600
Foro da incasso (mm)	550 x 480
Profondità Vasca (mm)	200
Installazione	Sopratop
Orientamento	Non reversibile

ACCESSORI CONSIGLIATI

93	97	25	50	153	156	163
164	5	75	71	9		

MATERIALI E COLORI

KERATEK <small>CERAMIC NANOTECHNOLOGY DNR</small>	Euro 636
Black K86	LKB10586
Dove Grey K93	LKB10593
Champagne K95	LKB10595
White K96	LKB10596
Light Grey K97	LKB10597
Dark Grey K99	LKB10599

GRANITEK <small>NATURAL GRANITE EFFECT</small>	Euro 502
METAL	
Titanium M73	LMB10573
Aluminium M79	LMB10579

MATT	Euro 482
Nero G40	LGB10540
Tortora G43	LGB10543
Cemento G48	LGB10548
Bianco G68	LGB10568
Espresso G78	LGB10578

CLASSIC	Euro 482
Avena G51	LGB10551
Antracite G59	LGB10559
Bianco Antico G62	LGB10562

BEST 104 NEW



Black
K86

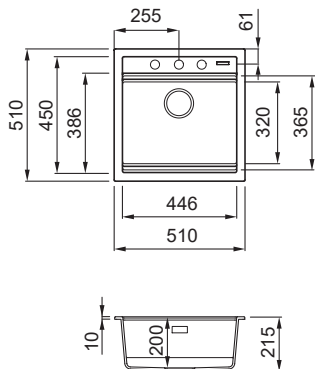

Lavello 1 vasca



CARATTERISTICHE

Dimensioni (mm)	510 x 510
Base (mm)	500 600 se inizio composizione
Foro da incasso (mm)	490 x 480
Profondità Vasca (mm)	200
Installazione	Sopratop
Orientamento	Non reversibile

ACCESSORI CONSIGLIATI

93	97	25	50	153	156	163
164	5	75	71	9		

MATERIALI E COLORI

KERATEK <small>CERAMIC NANOTECHNOLOGY DNR</small>	Euro 636
Black K86	LKB10486
Dove Grey K93	LKB10493
Champagne K95	LKB10495
White K96	LKB10496
Light Grey K97	LKB10497
Dark Grey K99	LKB10499

GRANITEK <small>NATURAL GRANITE EFFECT</small>	Euro 502
METAL	
Titanium M73	LMB10473
Aluminium M79	LMB10479

MATT	Euro 482
Nero G40	LGB10440
Tortora G43	LGB10443
Cemento G48	LGB10448
Bianco G68	LGB10468
Espresso G78	LGB10478

CLASSIC	Euro 482
Avena G51	LGB10451
Antracite G59	LGB10459
Bianco Antico G62	LGB10462



Lavello Best 130 | Miscelatore Wave Black BK | Piano induzione Urban 80



MAGGIORI
INFORMAZIONI
LINEA ZEN



LESS IS MORE

Il design senza tempo per dirsi tale deve resistere alle mode passeggere e deve potersi armonizzare con un'ampia varietà di ambienti. Abbiamo sviluppato una nuova linea che sottolinea sia la tecnologia sia la cura dei dettagli di Elleci e che si distingue dalla concorrenza grazie alla propria versatilità di utilizzo. In una parola... ZEN

PLUS **ZEN**



ACCESSORI
ELEMENT



FLOW PRO



SMART EDGE
6 MM

KERATEK[®]
CERAMIC NANOTECHNOLOGY CN6

-  **Black**
K86
-  **Dove Grey**
K93
-  **Champagne**
K95
-  **White**
K96
-  **Light Grey**
K97
-  **Dark Grey**
K99

I MODELLI ZEN

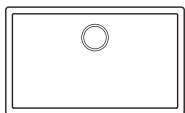

ZEN 130

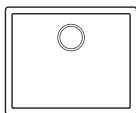

ZEN 105

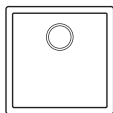

ZEN 102

Corredo del lavello: Sifone salvaspazio, piletta Flow Pro integrata, troppopieno rettangolare, ganci e kit montaggio Sottotop.

ACCESSORI CONSIGLIATI

91

**ELEMENT
TAGLIERE 420**
ATH040OL
Pag. 143



Finiture

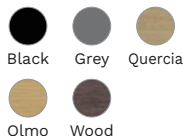

157

**ELEMENT DRAINER
FLEX 440**
ARS013BK
Pag. 144

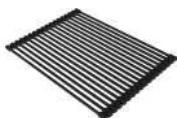

Finiture



152

**ELEMENT
COLANDER 418**
AVP035BK
Pag. 145



Finiture



IL PERFETTO MATCH MISCELATORI



CLUB - Black BK
MOKCLUBK

Pag. 163

Disponibile nelle colorazioni



OPTIONAL

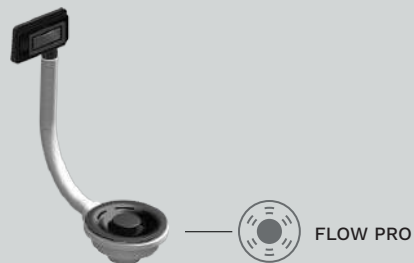

KIT ELEMENT
FLOW PRO + TROPPO PIENO BLACK
KITWPT-F-1VSLL-BK

Pag. 146

elleci | BEAUTY



Una linea di prodotti appositamente studiata per la cura dei lavelli in composito.

Scopri di più a pag. 200

*Per ulteriori informazioni vai alla sezione accessori a pag. 140

ZEN 130



Dark Grey
K99

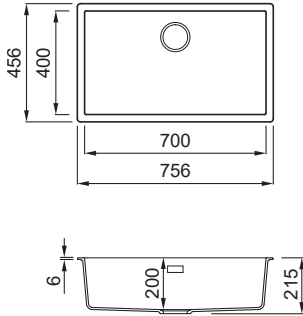

OPTIONAL



Pag. 146

MATERIALI E COLORI

KERATEK CERAMIC NANOTECHNOLOGY DNE		Euro 593
	Black K86	LKZ13086
	Dove Grey K93	LKZ13093
	Champagne K95	LKZ13095
	White K96	LKZ13096
	Light Grey K97	LKZ13097
	Dark Grey K99	LKZ13099

Lavello 1 vasca

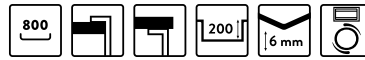

CARATTERISTICHE

Dimensioni (mm)	756 x 456
Base (mm)	800
Foro da incasso (mm)	745 x 445 R5 (Standard), 700 x 400 R10 (Sottotop)
Profondità Vasca (mm)	200
Installazione	Sopratop, Sottotop
Orientamento	Non reversibile

ACCESSORI CONSIGLIATI

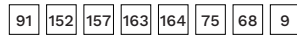

ZEN 105



Dark Grey
K99

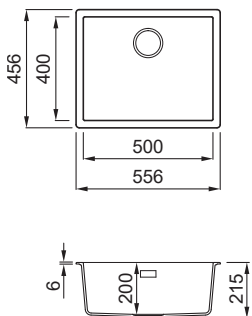

Lavello 1 vasca



CARATTERISTICHE

Dimensioni (mm)	556 x 456
Base (mm)	600
Foro da incasso (mm)	545 x 445 R5 (Standard), 500 x 400 R10 (Sottotop)
Profondità Vasca (mm)	200
Installazione	Sopratop, Sottotop
Orientamento	Non reversibile

ACCESSORI CONSIGLIATI

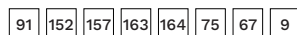

MATERIALI E COLORI

KERATEK CERAMIC NANOTECHNOLOGY DNE		Euro 537
	Black K86	LKZ10586
	Dove Grey K93	LKZ10593
	Champagne K95	LKZ10595
	White K96	LKZ10596
	Light Grey K97	LKZ10597
	Dark Grey K99	LKZ10599

ZEN 102



Dark Grey
K99

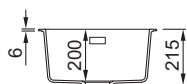
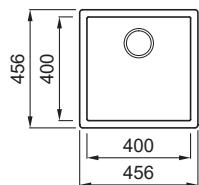

OPTIONAL



Pag. 146

MATERIALI E COLORI

KERATEX CERAMIC NANOTECHNOLOGY ONE		Euro 487
	Black K86	LKZ10286
	Dove Grey K93	LKZ10293
	Champagne K95	LKZ10295
	White K96	LKZ10296
	Light Grey K97	LKZ10297
	Dark Grey K99	LKZ10299

Lavello 1 vasca



CARATTERISTICHE

Dimensioni (mm)	456 x 456
Base (mm)	450 500 se inizio composizione (Sopratop), 500 (Sottotop)
Foro da incasso (mm)	445 x 445 R5 (Standard), 400 x 400 R10 (Sottotop)
Profondità Vasca (mm)	200
Installazione	Sopratop, Sottotop
Orientamento	Non reversibile

ACCESSORI CONSIGLIATI

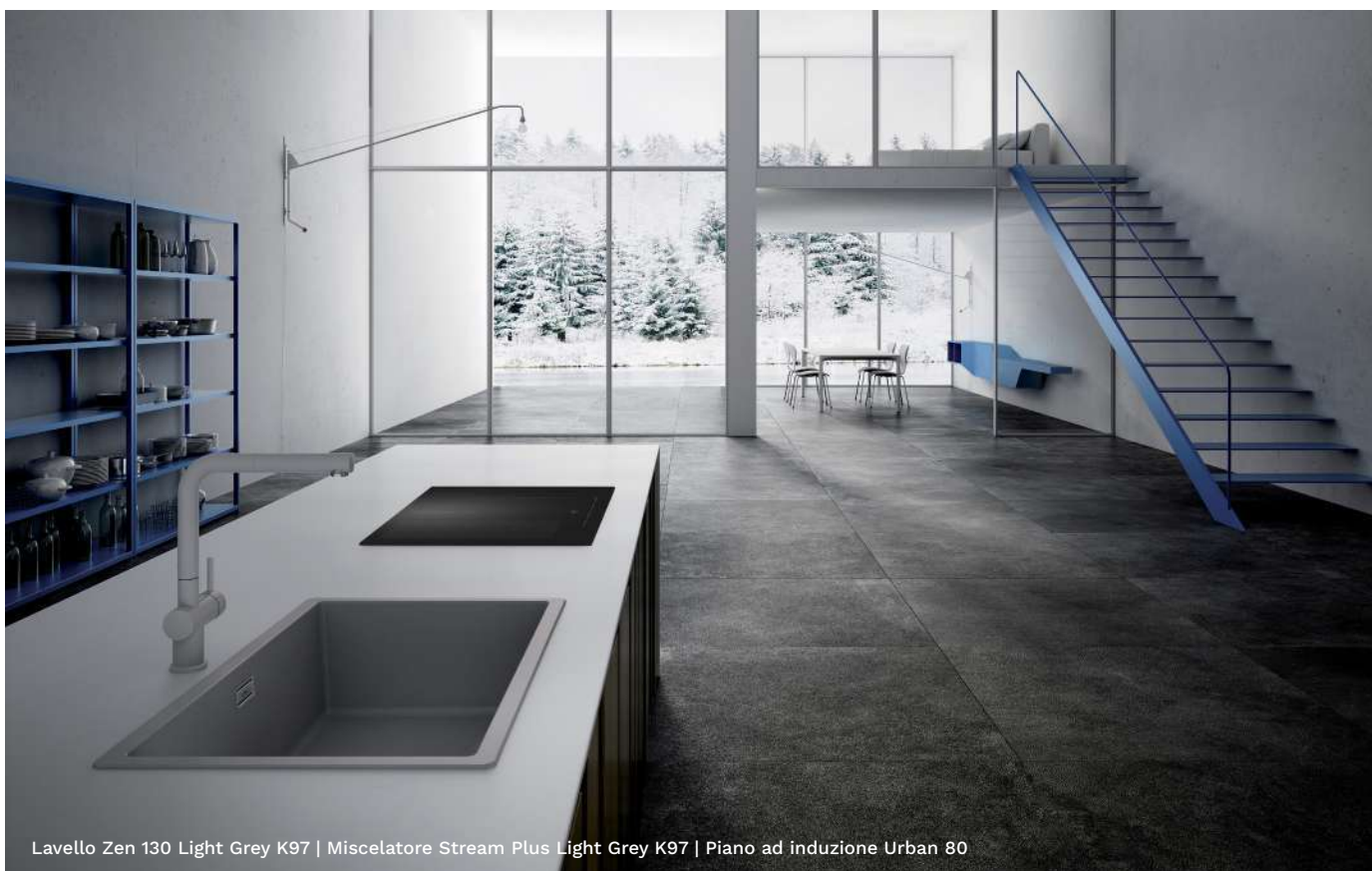
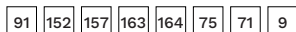

Lavello Zen 130 Light Grey K97 | Miscelatore Stream Plus Light Grey K97 | Piano ad induzione Urban 80



MAGGIORI
INFORMAZIONI
LINEA ZEN-F



ESTETICA SENZA INTERRUZIONI

Linee e forme in continuum sensoriale. Una linea di lavelli con installazione filo top che esalta la fluidità estetica tra piano e workstation. Un nome che si fa garante di relax, precisione e pulizia.

PLUS **ZEN-F**



ACCESSORI
ELEMENT



FLOW PRO

KERATEK[®]
CERAMIC NANOTECHNOLOGY CN6

-  **Black**
K86
-  **Dove Grey**
K93
-  **Champagne**
K95
-  **White**
K96
-  **Light Grey**
K97
-  **Dark Grey**
K99

I MODELLI ZEN-F

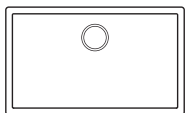

ZEN-F 130

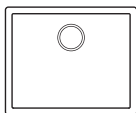

ZEN-F 105

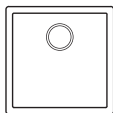

ZEN-F 102

Corredo del lavello: Sifone salvaspazio, piletta Flow Pro integrata, troppopieno rettangolare, ganci.

ACCESSORI CONSIGLIATI

91

**ELEMENT
TAGLIERE 420**
ATH040OL
Pag. 143



Finiture

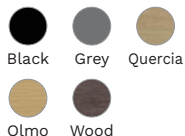

157

**ELEMENT DRAINER
FLEX 440**
ARS013BK
Pag. 144

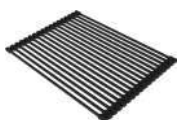

Finiture



152

**ELEMENT
COLANDER 418**
AVP035BK
Pag. 145



Finiture



IL PERFETTO MATCH MISCELATORI



TEMA - Black K86
MKKTEM86

Pag. 156

Disponibile nelle colorazioni

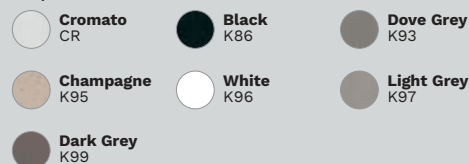

OPTIONAL

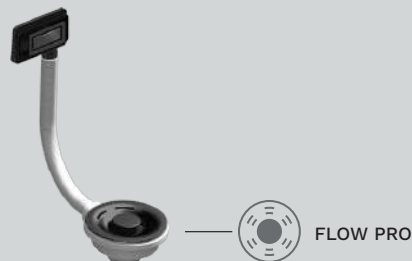

KIT ELEMENT
FLOW PRO + TROPPO PIENO BLACK
KITWPT-F-1VSL-L-BK

Pag. 146

elleci | BEAUTY



Una linea di prodotti appositamente studiata per la cura dei lavelli in composito.

Scopri di più a pag. 200

*Per ulteriori informazioni vai alla sezione accessori a pag. 140

ZEN-F 130 NEW



OPTIONAL



Pag. 146

Black
K86

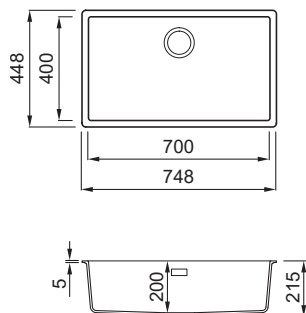

Lavello 1 vasca per installazione
Filotop



CARATTERISTICHE

Dimensioni (mm)	748 x 448
Base (mm)	800
Foro da incasso (mm)	Da dima*
Profondità Vasca (mm)	200
Installazione	Filotop
Orientamento	Non reversibile

MATERIALI E COLORI

KERATEK GERAMIC NANOTECHNOLOGY DNR		Euro 628
	Black K86	LKZ13086F01
	Dove Grey K93	LKZ13093F01
	Champagne K95	LKZ13095F01
	White K96	LKZ13096F01
	Light Grey K97	LKZ13097F01
	Dark Grey K99	LKZ13099F01

*dima inclusa nella confezione o scaricabile dalla sezione download specifica del sito www.elleci.com/it

ZEN-F 105 NEW



Black
K86

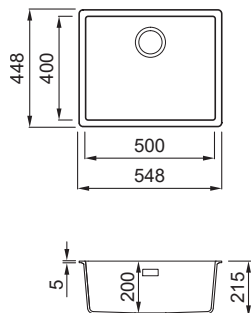

Lavello 1 vasca per installazione
Filotop



CARATTERISTICHE

Dimensioni (mm)	548 x 448
Base (mm)	600
Foro da incasso (mm)	Da dima*
Profondità Vasca (mm)	200
Installazione	Filotop
Orientamento	Non reversibile

MATERIALI E COLORI

KERATEK GERAMIC NANOTECHNOLOGY DNR		Euro 572
	Black K86	LKZ10586F01
	Dove Grey K93	LKZ10593F01
	Champagne K95	LKZ10595F01
	White K96	LKZ10596F01
	Light Grey K97	LKZ10597F01
	Dark Grey K99	LKZ10599F01

*dima inclusa nella confezione o scaricabile dalla sezione download specifica del sito www.elleci.com/it

ZEN-F 102 **NEW**



Black
K86

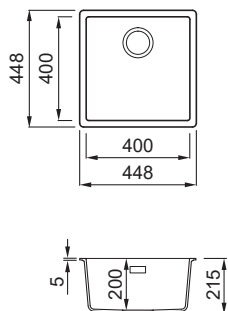

OPTIONAL



Pag. 146

MATERIALI E COLORI

KERATEX CERAMIC NANOTECHNOLOGY ONE		Euro 522
● Black K86		LKZ10286F01
● Dove Grey K93		LKZ10293F01
● Champagne K95		LKZ10295F01
● White K96		LKZ10296F01
● Light Grey K97		LKZ10297F01
● Dark Grey K99		LKZ10299F01

Lavello 1 vasca per installazione
Filotop



CARATTERISTICHE

Dimensioni (mm)	448 x 448
Base (mm)	500
Foro da incasso (mm)	Da dima*
Profondità Vasca (mm)	200
Installazione	Filotop
Orientamento	Non reversibile

*dima inclusa nella confezione o scaricabile dalla sezione download specifica del sito www.elleci.com/it



Lavello Zen F 105 Light Grey K97 | Miscelatore Wave Black BK



MAGGIORI
INFORMAZIONI
LINEA KARISMA



DESIGN CARISMATICO

Bordo "svasato" che invita ad un uso più armonioso del lavello. Pur mantenendo linee rette e decise, il design interviene per donare funzionalità e praticità. Lo smusso interno di 45°, che congiunge il bordo all'interno vasca, facilita le operazioni di PREPARING, CLEANING e COOKING nella Water Zone.

PLUS KARISMA



PILETTA
QUADRATA



TROPPOPIENO
RETTANGOLARE



AREA
ACCESSORI
INTEGRATA



BORDO K

GRANITEK[®]
NATURAL GRANITE EFFECT

-  **Titanium**
M73
-  **Aluminium**
M79
-  **Nero**
G40
-  **Tortora**
G43
-  **Bianco**
G68

I MODELLI KARISMA

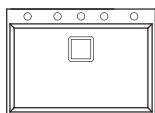

KARISMA 120 SOPRATOP

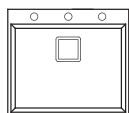

KARISMA 105 SOPRATOP

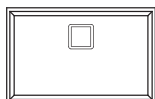

KARISMA 120 SOTTOTOP

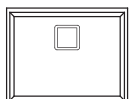

KARISMA 105 SOTTOTOP

Corredo del lavello: Sifone salvaspazio, piletta quadrata, troppopieno rettangolare e ganci.

ACCESSORI CONSIGLIATI

88

ELEMENT TAGLIERE SLIDING 50 CM

ATH010QU
Pag. 142



Finiture

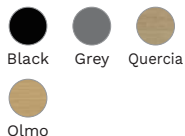

5

COLANDER

AVI03001
Pag. 150



157

ELEMENT DRAINER FLEX 440

ARS013BK
Pag. 144

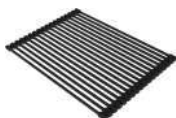

Finiture



75

CESTELLO

ACI01307
Pag. 151



*Per ulteriori informazioni vai alla sezione accessori a pag. 140

IL PERFETTO MATCH MISCELATORI



TOURMALINE - Nero G40 MGKTOU40

Pag. 160

Disponibile nelle colorazioni

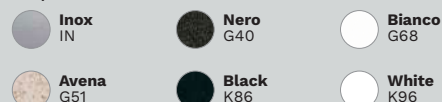

OPTIONAL



KIT ELEMENT

ELEMENT DISPENSER SAPONE QUADRATO ADI02301

Pag. 145

elleci | BEAUTY



Una linea di prodotti appositamente studiata per la cura dei lavelli in composito.

Scopri di più a pag. 200

KARISMA 120



Bianco
G68

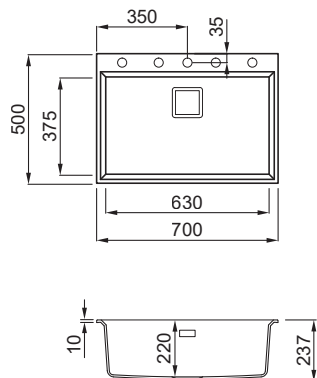

Lavello 1 vasca



CARATTERISTICHE

Dimensioni (mm)	700 x 500
Base (mm)	800
Foro da incasso (mm)	680 x 480
Profondità Vasca (mm)	220
Installazione	Sopratop
Orientamento	Non reversibile

ACCESSORI CONSIGLIATI

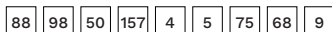

MATERIALI E COLORI

METAL		Titanium M73	Euro 474 LMK12073
		Aluminium M79	LMK12079
MATT		Nero G40	Euro 447 LGK12040
		Tortora G43	LGK12043
		Bianco G68	LGK12068

KARISMA 105



Bianco
G68

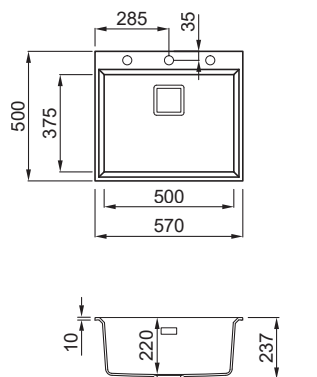

Lavello 1 vasca



CARATTERISTICHE

Dimensioni (mm)	570 x 500
Base (mm)	600
Foro da incasso (mm)	550 x 480
Profondità Vasca (mm)	220
Installazione	Sopratop
Orientamento	Non reversibile

ACCESSORI CONSIGLIATI

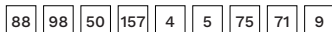

MATERIALI E COLORI

METAL		Titanium M73	Euro 384 LMK10573
		Aluminium M79	LMK10579
MATT		Nero G40	Euro 364 LGK10540
		Tortora G43	LGK10543
		Bianco G68	LGK10568

KARISMA 120 SOTTOTOP



Titanium
M73

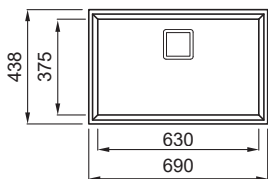

Lavello 1 vasca



CARATTERISTICHE

Dimensioni (mm)	690 x 438
Base (mm)	800
Foro da incasso (mm)	664 x 411 R5
Profondità Vasca (mm)	220
Installazione	Sottotop
Orientamento	Non reversibile

ACCESSORI CONSIGLIATI

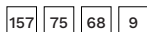

MATERIALI E COLORI

GRANITEK
NATURAL GRANITE EFFECT

METAL

- Titanium M73
- Aluminium M79

Euro **492**
LMK12073BSO
LMK12079BSO

MATT

- Nero G40
- Tortora G43
- Bianco G68

Euro **474**
LGK12040BSO
LGK12043BSO
LGK12068BSO

KARISMA 105 SOTTOTOP

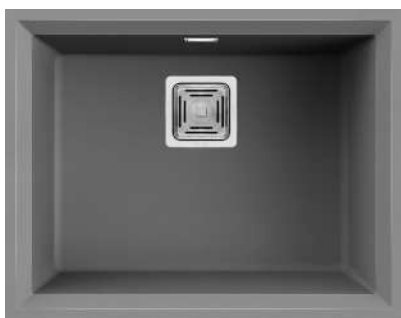

Titanium
M73

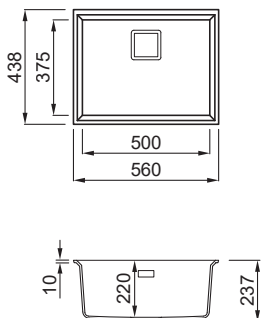

Lavello 1 vasca



CARATTERISTICHE

Dimensioni (mm)	560 x 438
Base (mm)	600
Foro da incasso (mm)	534 x 411 R5
Profondità Vasca (mm)	220
Installazione	Sottotop
Orientamento	Non reversibile

ACCESSORI CONSIGLIATI

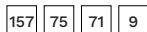

MATERIALI E COLORI

GRANITEK
NATURAL GRANITE EFFECT

METAL

- Titanium M73
- Aluminium M79

Euro **398**
LMK10573BSO
LMK10579BSO

MATT

- Nero G40
- Tortora G43
- Bianco G68

Euro **380**
LGK10540BSO
LGK10543BSO
LGK10568BSO



MAGGIORI
INFORMAZIONI
LINEA INTEGRA



DESIGN MODERNO CHE SVELA L'ECCELLENZA

Una linea sottotop con la possibilità di integrazione con il piano lavoro. L'utilizzo di componenti come la nuova piletta FLOW PRO ed il troppopieno rettangolare contribuiscono a conferire a questa collezione un aspetto elegante dal design minimale.

PLUS **INTEGRA**



GIUNZIONE
INVISIBILE



TROPPOPIENO
RETTANGOLARE

KERATEK[®]
CERAMIC NANOTECHNOLOGY CN6

● **Black**
K86

● **Dove Grey**
K93

● **White**
K96

● **Dark Grey**
K99

I MODELLI INTEGRA

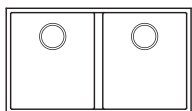

INTEGRA 350

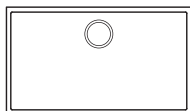

INTEGRA 130

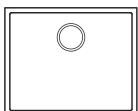

INTEGRA 105

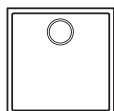

INTEGRA 102

Corredo del lavello: Sifone salvaspazio, piletta Flow Pro integrata e troppopieno rettangolare.

ACCESSORI CONSIGLIATI

91

**ELEMENT
TAGLIERE 420**
ATH040OL
Pag. 142



Finiture

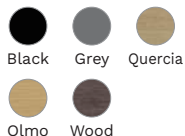

157

**ELEMENT DRAINER
FLEX 440**
ARS013BK
Pag. 144



Finiture



152

**ELEMENT
COLANDER 418**
AVP035BK
Pag. 145



Finiture



68

BOTTOM GRID L
AGB01303
Pag. 150

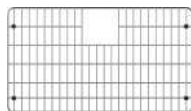

IL PERFETTO MATCH MISCELATORI



TRAIL - Nero G40
MGKTRA40

Pag. 159

Disponibile nelle colorazioni



OPTIONAL

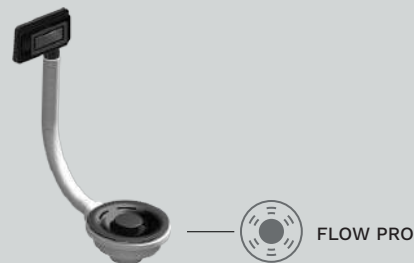

KIT ELEMENT
FLOW PRO + TROPPO PIENO BLACK
KITWPT-F-1VSL-L-BK

Pag. 146

elleci | BEAUTY



Una linea di prodotti appositamente studiata per la cura dei lavelli in composito.

Scopri di più a pag. 200

*Per ulteriori informazioni vai alla sezione accessori a pag. 140

INTEGRA 350



OPTIONAL



Pag. 146

White
K96

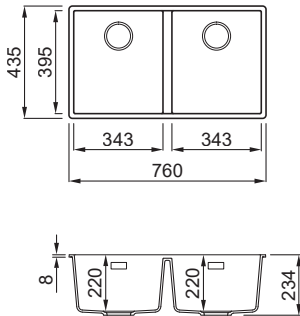

Lavello 2 vasche



CARATTERISTICHE

Dimensioni (mm)	760 x 435
Base (mm)	800
Foro da incasso (mm)	720 x 395 R5
Profondità Vasca 1 (mm)	220
Profondità Vasca 2 (mm)	220
Installazione	Integrato e Sottotop
Orientamento	Non reversibile

ACCESSORI CONSIGLIATI

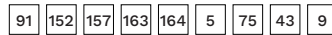

MATERIALI E COLORI

KERATEX CERAMIC NANOTECHNOLOGY DNR	Euro 648
Black K86	LKQ35086BIN
Dove Grey K93	LKQ35093BIN
White K96	LKQ35096BIN
Dark Grey K99	LKQ35099BIN

INTEGRA 130



White
K96

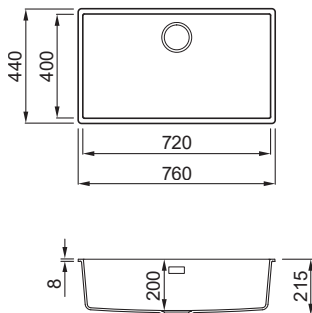

Lavello 1 vasca



CARATTERISTICHE

Dimensioni (mm)	760 x 440
Base (mm)	800
Foro da incasso (mm)	720 x 400 R5
Profondità Vasca (mm)	200
Installazione	Integrato e Sottotop
Orientamento	Non reversibile

ACCESSORI CONSIGLIATI

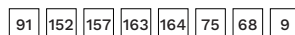

MATERIALI E COLORI

KERATEX CERAMIC NANOTECHNOLOGY DNR	Euro 565
Black K86	LKQ13086BIN
Dove Grey K93	LKQ13093BIN
White K96	LKQ13096BIN
Dark Grey K99	LKQ13099BIN

INTEGRA 105



Dark Grey
K99

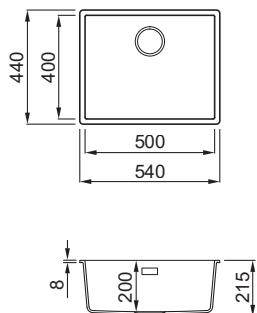

OPTIONAL



Pag. 146

MATERIALI E COLORI

KERATEX CERAMIC NANOTECHNOLOGY ONE		Euro 514
	Black K86	LKQ10586BIN
	Dove Grey K93	LKQ10593BIN
	White K96	LKQ10596BIN
	Dark Grey K99	LKQ10599BIN

Lavello 1 vasca



CARATTERISTICHE

Dimensioni (mm)	540 x 440
Base (mm)	600
Foro da incasso (mm)	500 x 400 R5
Profondità Vasca (mm)	200
Installazione	Integrato e Sottotop
Orientamento	Non reversibile

ACCESSORI CONSIGLIATI

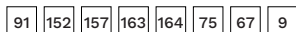

INTEGRA 102

NEW



Dark Grey
K99

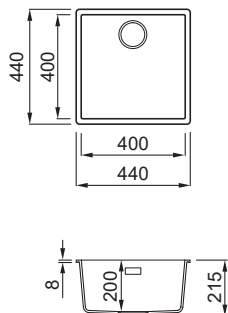

Lavello 1 vasca



CARATTERISTICHE

Dimensioni (mm)	440 x 440
Base (mm)	500
Foro da incasso (mm)	400 x 400 R5
Profondità Vasca (mm)	200
Installazione	Integrato e Sottotop
Orientamento	Non reversibile

ACCESSORI CONSIGLIATI

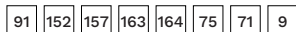

MATERIALI E COLORI

KERATEX CERAMIC NANOTECHNOLOGY ONE		Euro 514
	Black K86	LKQ10286BIN
	Dove Grey K93	LKQ10293BIN
	White K96	LKQ10296BIN
	Dark Grey K99	LKQ10299BIN



MAGGIORI
INFORMAZIONI
LINEA QUADRA



DESIGN MINIMAL E STILE CONTEMPORANEO

Una collezione minimale che grazie alla sua semplicità riesce a mettere in risalto le linee moderne e pulite che la caratterizzano. Ogni modello è combinabile con numerosi accessori e molteplici colorazioni.

PLUS **QUADRA**





ACCESSORI
ELEMENT



AREA
ACCESSORI
INTEGRATA

GRANITEK[®]
NATURAL GRANITE EFFECT

-  **Titanium**
M73
-  **Aluminium**
M79
-  **Nero**
G40
-  **Tortora**
G43
-  **Cemento**
G48
-  **Bianco**
G68
-  **Espresso**
G78

-  **Avena**
G51
-  **Antracite**
G59
-  **Bianco Antico**
G62

KERATEK[®]
CERAMIC NANOTECHNOLOGY CN6

-  **Black**
K86
-  **Dove Grey**
K93
-  **Champagne**
K95
-  **White**
K96
-  **Light Grey**
K97
-  **Dark Grey**
K99

I MODELLI QUADRA

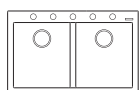

QUADRA 350

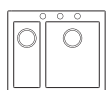

QUADRA 150

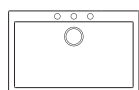

QUADRA 130

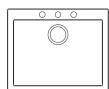

QUADRA 110

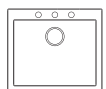

QUADRA 105



QUADRA 102



QUADRA 100



QUADRA 50

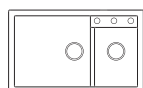

QUADRA 440

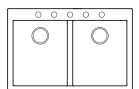

QUADRA 340

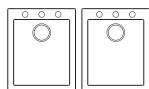

QUADRA 200

Corredo del lavello: Sifone salvaspazio, troppopieno tondo, pilette e ganci.

ACCESSORI CONSIGLIATI

91

**ELEMENT
TAGLIERE 420**
ATH040OL
Pag. 142



Finiture



157

**ELEMENT DRAINER
FLEX 440**
ARS013BK
Pag. 144

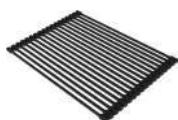

Finiture



152

**ELEMENT
COLANDER 418**
AVP035BK
Pag. 145



Finiture



25

**ELEMENT DISPENSER
SAPONE TONDO**
ADI02300BK
Pag. 145



Finiture



IL PERFETTO MATCH MISCELATORI



TEMA - Black BK
MOKTEMBK

Pag. 156

Disponibile nelle colorazioni



OPTIONAL



KIT ELEMENT
ELEMENT DISPENSER SAPONE TONDO
ADI02300

Pag. 145

elleci | BEAUTY



Una linea di prodotti appositamente studiata per la cura dei lavelli in composito.

Scopri di più a pag. 200

*Per ulteriori informazioni vai alla sezione accessori a pag. 140

QUADRA 130



Bianco
G68

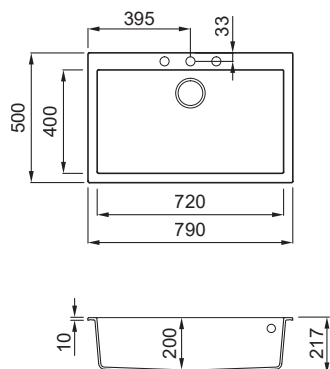

Lavello 1 vasca



CARATTERISTICHE

Dimensioni (mm)	790 x 500
Base (mm)	800
Foro da incasso (mm)	770 x 480
Profondità Vasca (mm)	200
Installazione	Sopratop
Orientamento	Non reversibile

ACCESSORI CONSIGLIATI

91	97	25	50	152	157	163
4	5	75	68	9		

MATERIALI E COLORI

KERATEK GERMIC NANOTECHNOLOGY DNR		Euro 518
	Black K86	LKQ13086
	Dove Grey K93	LKQ13093
	Champagne K95	LKQ13095
	White K96	LKQ13096
	Light Grey K97	LKQ13097
	Dark Grey K99	LKQ13099

GRANITEK NATURAL GRANITE EFFECT		Euro 418
	Titanium M73	LMQ13073
	Aluminium M79	LMQ13079

MATT		Euro 394
	Nero G40	LGQ13040
	Tortora G43	LGQ13043
	Cemento G48	LGQ13048
	Bianco G68	LGQ13068
	Espresso G78	LGQ13078

CLASSIC		Euro 394
	Avena G51	LGQ13051
	Antracite G59	LGQ13059
	Bianco Antico G62	LGQ13062

QUADRA 110



Bianco
G68

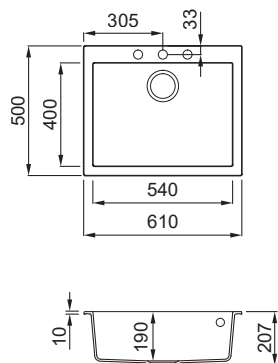

Lavello 1 vasca



CARATTERISTICHE

Dimensioni (mm)	610 x 500
Base (mm)	600 800 se inizio composizione
Foro da incasso (mm)	590 x 480
Profondità Vasca (mm)	190
Installazione	Sopratop
Orientamento	Non reversibile

ACCESSORI CONSIGLIATI

91	97	25	50	152	157	163
4	5	75	67	9		

MATERIALI E COLORI

KERATEK GERMIC NANOTECHNOLOGY DNR		Euro 466
	Black K86	LKQ11086
	Dove Grey K93	LKQ11093
	Champagne K95	LKQ11095
	White K96	LKQ11096
	Light Grey K97	LKQ11097
	Dark Grey K99	LKQ11099

GRANITEK NATURAL GRANITE EFFECT		Euro 382
	Titanium M73	LMQ11073
	Aluminium M79	LMQ11079

MATT		Euro 357
	Nero G40	LGQ11040
	Tortora G43	LGQ11043
	Cemento G48	LGQ11048
	Bianco G68	LGQ11068
	Espresso G78	LGQ11078

CLASSIC		Euro 357
	Avena G51	LGQ11051
	Antracite G59	LGQ11059
	Bianco Antico G62	LGQ11062

QUADRA 105



Dark Grey
K99

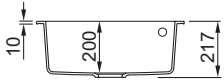
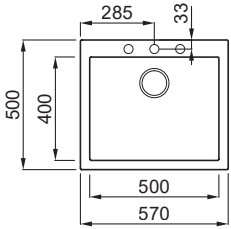

Lavello 1 vasca



CARATTERISTICHE

Dimensioni (mm)	570 x 500
Base (mm)	600
Foro da incasso (mm)	550 x 480
Profondità Vasca (mm)	200
Installazione	Sopratop
Orientamento	Non reversibile

ACCESSORI CONSIGLIATI

91	97	25	50	152	163	4
5	75	67	9			

MATERIALI E COLORI

KERATEX <small>CERAMIC NANOTECHNOLOGY ONE</small>	Euro 466
Black K86	LKQ10586
Dove Grey K93	LKQ10593
Champagne K95	LKQ10595
White K96	LKQ10596
Light Grey K97	LKQ10597
Dark Grey K99	LKQ10599

GRANITEK <small>NATURAL GRANITE EFFECT</small>	Euro 382
METAL	
Titanium M73	LMQ10573
Aluminium M79	LMQ10579

MATT	Euro 357
Nero G40	LGQ10540
Tortora G43	LGQ10543
Cemento G48	LGQ10548
Bianco G68	LGQ10568
Espresso G78	LGQ10578

CLASSIC	Euro 357
Avena G51	LGQ10551
Antracite G59	LGQ10559
Bianco Antico G62	LGQ10562

QUADRA 102



Dark Grey
K99

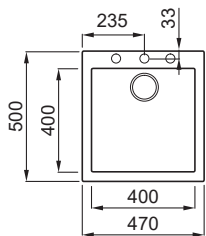

Lavello 1 vasca

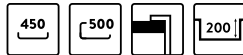

CARATTERISTICHE

Dimensioni (mm)	470 x 500
Base (mm)	450 500 se inizio composizione
Foro da incasso (mm)	450 x 480
Profondità Vasca (mm)	200
Installazione	Sopratop
Orientamento	Non reversibile

ACCESSORI CONSIGLIATI

91	97	25	50	152	163	4	5	75
43	9							

MATERIALI E COLORI

KERATEX <small>CERAMIC NANOTECHNOLOGY ONE</small>	Euro 466
Black K86	LKQ10286
Dove Grey K93	LKQ10293
Champagne K95	LKQ10295
White K96	LKQ10296
Light Grey K97	LKQ10297
Dark Grey K99	LKQ10299

GRANITEK <small>NATURAL GRANITE EFFECT</small>	Euro 382
METAL	
Titanium M73	LMQ10273
Aluminium M79	LMQ10279

MATT	Euro 357
Nero G40	LGQ10240
Tortora G43	LGQ10243
Cemento G48	LGQ10248
Bianco G68	LGQ10268
Espresso G78	LGQ10278

CLASSIC	Euro 357
Avena G51	LGQ10251
Antracite G59	LGQ10259
Bianco Antico G62	LGQ10262

QUADRA 100



Nero G40

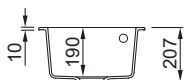
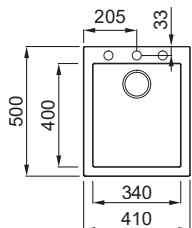

Lavello 1 vasca



CARATTERISTICHE

Dimensioni (mm)	410 x 500
Base (mm)	450
Foro da incasso (mm)	390 x 480
Profondità Vasca (mm)	190
Installazione	Sopratop
Orientamento	Non reversibile

ACCESSORI CONSIGLIATI

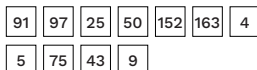

MATERIALI E COLORI

KERATEK GERMIC NANOTECHNOLOGY DNE	Euro 373
Black K86	LKQ10086
Dove Grey K93	LKQ10093
Champagne K95	LKQ10095
White K96	LKQ10096
Light Grey K97	LKQ10097
Dark Grey K99	LKQ10099

GRANITEK NATURAL GRANITE EFFECT	Euro 298
METAL Titanium M73	LMQ10073
Aluminium M79	LMQ10079

MATT Nero G40	Euro 281 LGQ10040
Tortora G43	LGQ10043
Cemento G48	LGQ10048
Bianco G68	LGQ10068
Espresso G78	LGQ10078

CLASSIC Avena G51	Euro 281 LGQ10051
Antracite G59	LGQ10059
Bianco Antico G62	LGQ10062

QUADRA 50



Nero G40

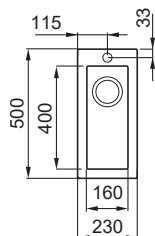

Lavello 1 vasca



CARATTERISTICHE

Dimensioni (mm)	230 x 500
Base (mm)	300
Foro da incasso (mm)	Da dima*
Profondità Vasca (mm)	155
Installazione	Sopratop
Orientamento	Non reversibile

ACCESSORI CONSIGLIATI



MATERIALI E COLORI

KERATEK GERMIC NANOTECHNOLOGY DNE	Euro 308
Black K86	LKQ05086
Dove Grey K93	LKQ05093
Champagne K95	LKQ05095
White K96	LKQ05096
Light Grey K97	LKQ05097
Dark Grey K99	LKQ05099

GRANITEK NATURAL GRANITE EFFECT	Euro 246
METAL Titanium M73	LMQ05073
Aluminium M79	LMQ05079

MATT Nero G40	Euro 235 LGQ05040
Tortora G43	LGQ05043
Cemento G48	LGQ05048
Bianco G68	LGQ05068
Espresso G78	LGQ05078

CLASSIC Avena G51	Euro 235 LGQ05051
Antracite G59	LGQ05059
Bianco Antico G62	LGQ05062

*dima inclusa nella confezione o scaricabile dalla sezione download specifica del sito www.elleci.com/it

QUADRA 350



Bianco
G68

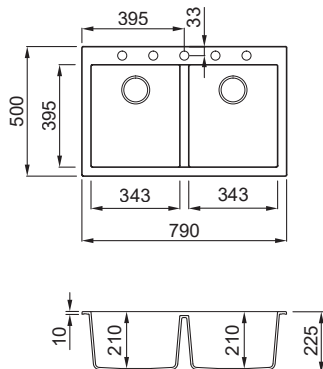

Lavello 2 vasche



CARATTERISTICHE

Dimensioni (mm) **790 x 500**
 Base (mm) **800**
 Foro da incasso (mm) **770 x 480**
 Profondità Vasca 1 (mm) **210**
 Profondità Vasca 2 (mm) **210**
 Installazione **Sopratop**
 Orientamento **Non reversibile**

ACCESSORI CONSIGLIATI

91	96	25	50	152	157	163
4	5	75	43	9		

MATERIALI E COLORI

KERATEK GERAMA NANOTECHNOLOGY ONE	Euro 593
Black K86	LKQ35086
Dove Grey K93	LKQ35093
Champagne K95	LKQ35095
White K96	LKQ35096
Light Grey K97	LKQ35097
Dark Grey K99	LKQ35099

GRANITEK NATURAL GRANITE EFFECT	Euro 482
METAL	
Titanium M73	LMQ35073
Aluminium M79	LMQ35079

MATT	Euro 451
Nero G40	LGQ35040
Tortora G43	LGQ35043
Cemento G48	LGQ35048
Bianco G68	LGQ35068
Espresso G78	LGQ35078

CLASSIC	Euro 451
Avena G51	LGQ35051
Antracite G59	LGQ35059
Bianco Antico G62	LGQ35062

QUADRA 340



Bianco
G68

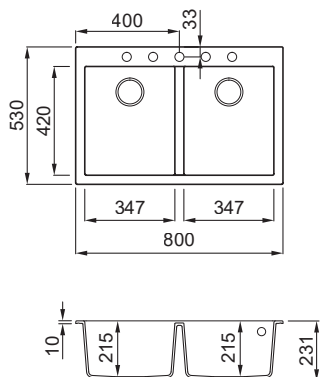

Lavello 2 vasche

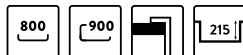

CARATTERISTICHE

Dimensioni (mm) **800 x 530**
 Base (mm) **800 ||| 900 se inizio composizione**
 Foro da incasso (mm) **780 x 510**
 Profondità Vasca 1 (mm) **215**
 Profondità Vasca 2 (mm) **215**
 Installazione **Sopratop**
 Orientamento **Non reversibile**

ACCESSORI CONSIGLIATI

96	25	50	156	163	5	75
43	9					

MATERIALI E COLORI

GRANITEK NATURAL GRANITE EFFECT	Euro 528
METAL	
Titanium M73	LMQ34073BTP
Aluminium M79	LMQ34079BTP
MATT	Euro 500
Nero G40	LGQ34040BTP
Tortora G43	LGQ34043BTP
Bianco G68	LGQ34068BTP

CLASSIC	Euro 500
Avena G51	LGQ34051BTP

QUADRA 440

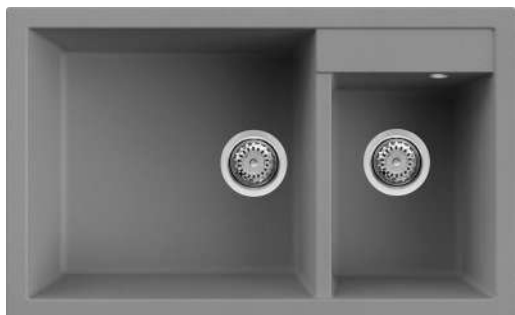

Titanium M73

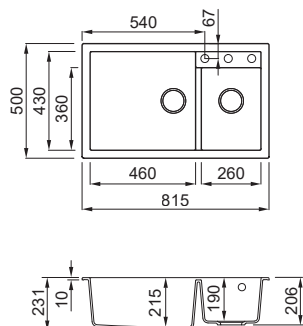

Lavello 2 vasche



CARATTERISTICHE

Dimensioni (mm) **815 x 500**
 Base (mm) **800 ||| 900 se inizio composizione**
 Foro da incasso (mm) **800 x 480**
 Profondità Vasca 1 (mm) **215**
 Profondità Vasca 2 (mm) **190**
 Installazione **Sopratop**
 Orientamento **Non reversibile**

ACCESSORI CONSIGLIATI

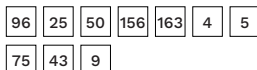

MATERIALI E COLORI

		GRANITEK NATURAL GRANITE EFFECT	Euro 553
METAL		Titanium M73	LMQ44073
		Aluminium M79	LMQ44079
			Euro 524
MATT		Nero G40	LGQ44040
		Tortora G43	LGQ44043
		Bianco G68	LGQ44068
			Euro 524
CLASSIC		Avena G51	LGQ44051

QUADRA 150



Titanium M73

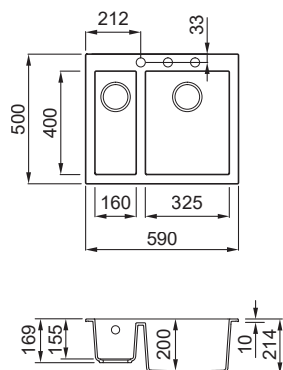

Lavello 2 vasche



CARATTERISTICHE

Dimensioni (mm) **590 x 500**
 Base (mm) **600**
 Foro da incasso (mm) **570 x 480**
 Profondità Vasca 1 (mm) **200**
 Profondità Vasca 2 (mm) **155**
 Installazione **Sopratop**
 Orientamento **Non reversibile**

ACCESSORI CONSIGLIATI



MATERIALI E COLORI

		KERATEK CERAMIC NANOTECHNOLOGY ONE	Euro 518
METAL		Black K86	LKQ15086
		Dove Grey K93	LKQ15093
		Champagne K95	LKQ15095
		White K96	LKQ15096
		Light Grey K97	LKQ15097
		Dark Grey K99	LKQ15099
METAL		Titanium M73	LMQ15073
		Aluminium M79	LMQ15079
			Euro 394
MATT		Nero G40	LGQ15040
		Tortora G43	LGQ15043
		Cemento G48	LGQ15048
		Bianco G68	LGQ15068
		Espresso G78	LGQ15078
			Euro 394
CLASSIC		Avena G51	LGQ15051
		Antracite G59	LGQ15059
		Bianco Antico G62	LGQ15062

QUADRA 200



Nero G40

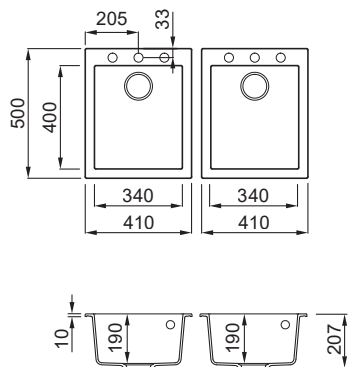

Lavello 2 vasche



CARATTERISTICHE

Dimensioni (mm) **410 x 500 + 410 x 500**
 Base (mm) **900**
 Foro da incasso (mm) **390 x 480 + 390 x 480**
 (distanza min 50 mm, max 150 mm)
 Profondità Vasca 1 (mm) **190**
 Profondità Vasca 2 (mm) **190**
 Installazione **Sopratop**
 Orientamento **Non reversibile**

ACCESSORI CONSIGLIATI

91	97	25	50	152	157	163
4	5	75	43	9		

MATERIALI E COLORI

KERATEK CERAMIC NANOTECHNOLOGY ONE		Euro 668
● Black K86		LKQ20086
● Dove Grey K93		LKQ20093
● Champagne K95		LKQ20095
● White K96		LKQ20096
● Light Grey K97		LKQ20097
● Dark Grey K99		LKQ20099

GRANITEK NATURAL GRANITE EFFECT		Euro 533
METAL ● Titanium M73		LMQ20073
METAL ● Aluminium M79		LMQ20079
Euro 512		
MATT ● Nero G40		LGQ20040
MATT ● Tortora G43		LGQ20043
MATT ● Cemento G48		LGQ20048
MATT ● Bianco G68		LGQ20068
MATT ● Espresso G78		LGQ20078
Euro 512		
CLASSIC ● Avena G51		LGQ20051
CLASSIC ● Antracite G59		LGQ20059
CLASSIC ● Bianco Antico G62		LGQ20062



Lavello Quadra 130 Titanium M73 | Miscelatore Tema Black K86

COLLEZIONE
QUADRA SOTTOTOP



MAGGIORI
INFORMAZIONI
LINEA QUADRA SOTTOTOP



QUANDO LA CREATIVITÀ SI TRASFORMA IN FUNZIONALITÀ

Questa collezione è stata pensata per ottimizzare al massimo l'incasso del lavello per raggiungere una totale pulizia del top da cucina.

PLUS **QUADRA SOTTOTOP**



ACCESSORI
ELEMENT



INSTALLAZIONE
MIXER SU TOP



OPTIONAL
ELEMENT
COVER
MATERICA

GRANITEK[®]
NATURAL GRANITE EFFECT

- Titanium**
M73
- Aluminium**
M79
- Nero**
G40
- Tortora**
G43
- Cemento**
G48
- Bianco**
G68
- Espresso**
G78

- Avena**
G51
- Antracite**
G59
- Bianco Antico**
G62

KERATEK[®]
CERAMIC NANOTECHNOLOGY CN6

- Black**
K86
- Dove Grey**
K93
- Champagne**
K95
- White**
K96
- Light Grey**
K97
- Dark Grey**
K99

I MODELLI QUADRA SOTTOTOP

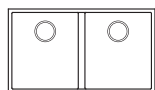

QUADRA 350

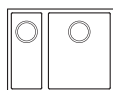

QUADRA 150

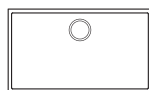

QUADRA 130

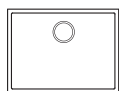

QUADRA 110

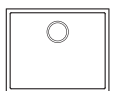

QUADRA 105



QUADRA 102



QUADRA 100



QUADRA 50

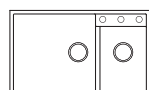

QUADRA 440

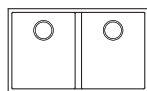

QUADRA 340

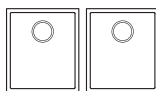

QUADRA 200

Corredo del lavello: Sifone salvaspazio, troppopieno tondo, pilette e ganci.

ACCESSORI CONSIGLIATI

157

**ELEMENT DRAINER
FLEX 440**
ARS013BK
Pag. 144

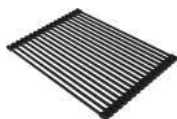

Finiture



Black

152

**ELEMENT
COLANDER 418**
AVP035BK
Pag. 145



Finiture



Black

75

CESTELLO

ACI01307
Pag. 151



68

BOTTOM GRID L

AGB01303
Pag. 150

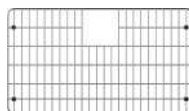

*Per ulteriori informazioni vai alla sezione accessori a pag. 140

IL PERFETTO MATCH MISCELATORI



**ADIGE - Inox IN
MİKADIIN**

Pag. 162

Disponibile nelle colorazioni



Inox
IN



Nero
G40



Bianco
G68



Black
K86



White
K96

OPTIONAL



**KIT ELEMENT
ELEMENT DISPENSER SAPONE TONDO
ADI02300**

Pag. 145

elleci | BEAUTY



Una linea di prodotti appositamente studiata per la cura dei lavelli in composito.

Scopri di più a pag. 200

QUADRA 130 SOTTOTOP



White
K96

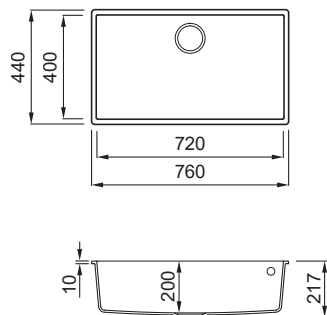

Lavello 1 vasca



CARATTERISTICHE

Dimensioni (mm) **760 x 440**
 Base (mm) **800**
 Foro da incasso (mm) **720 x 400 R5**
 Profondità Vasca (mm) **200**
 Installazione **Sottotop**
 Orientamento **Non reversibile**

ACCESSORI CONSIGLIATI

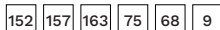

MATERIALI E COLORI

KERATEK GERMIC NANOTECHNOLOGY DNE		Euro 538
	Black K86	LKQ13086BSO
	Dove Grey K93	LKQ13093BSO
	Champagne K95	LKQ13095BSO
	White K96	LKQ13096BSO
	Light Grey K97	LKQ13097BSO
	Dark Grey K99	LKQ13099BSO

GRANITEK NATURAL GRANITE EFFECT		Euro 440
	Titanium M73	LMQ13073BSO
	Aluminium M79	LMQ13079BSO

MATT		Euro 418
	Nero G40	LGQ13040BSO
	Tortora G43	LGQ13043BSO
	Cemento G48	LGQ13048BSO
	Bianco G68	LGQ13068BSO
	Espresso G78	LGQ13078BSO

CLASSIC		Euro 418
	Avena G51	LGQ13051BSO
	Antracite G59	LGQ13059BSO
	Bianco Antico G62	LGQ13062BSO

QUADRA 110 SOTTOTOP



White
K96

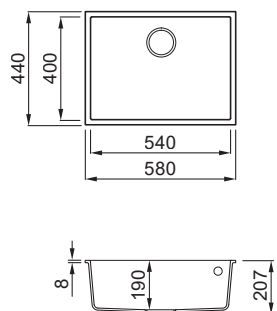

Lavello 1 vasca



CARATTERISTICHE

Dimensioni (mm) **580 x 440**
 Base (mm) **800**
 Foro da incasso (mm) **540 x 400 R5**
 Profondità Vasca (mm) **190**
 Installazione **Sottotop**
 Orientamento **Non reversibile**

ACCESSORI CONSIGLIATI

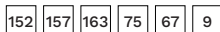

MATERIALI E COLORI

KERATEK GERMIC NANOTECHNOLOGY DNE		Euro 490
	Black K86	LKQ11086BSO
	Dove Grey K93	LKQ11093BSO
	Champagne K95	LKQ11095BSO
	White K96	LKQ11096BSO
	Light Grey K97	LKQ11097BSO
	Dark Grey K99	LKQ11099BSO

GRANITEK NATURAL GRANITE EFFECT		Euro 406
	Titanium M73	LMQ11073BSO
	Aluminium M79	LMQ11079BSO

MATT		Euro 382
	Nero G40	LGQ11040BSO
	Tortora G43	LGQ11043BSO
	Cemento G48	LGQ11048BSO
	Bianco G68	LGQ11068BSO
	Espresso G78	LGQ11078BSO

CLASSIC		Euro 382
	Avena G51	LGQ11051BSO
	Antracite G59	LGQ11059BSO
	Bianco Antico G62	LGQ11062BSO

QUADRA 105 SOTTOTOP



Tortora
G43

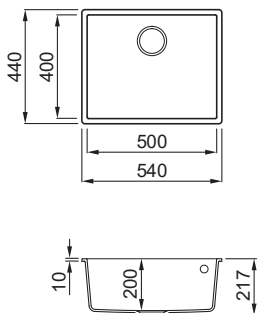

Lavello 1 vasca



CARATTERISTICHE

Dimensioni (mm) **540 x 440**
 Base (mm) **600**
 Foro da incasso (mm) **500 x 400 R5**
 Profondità Vasca (mm) **200**
 Installazione **Sottotop**
 Orientamento **Non reversibile**

ACCESSORI CONSIGLIATI

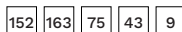

MATERIALI E COLORI

KERATEX GERAM: NANOTECHNOLOGY ONE		Euro 490
● Black K86		LKQ10586BSO
● Dove Grey K93		LKQ10593BSO
● Champagne K95		LKQ10595BSO
● White K96		LKQ10596BSO
● Light Grey K97		LKQ10597BSO
● Dark Grey K99		LKQ10599BSO

GRANITEK NATURAL GRANITE EFFECT

GRANITEK NATURAL GRANITE EFFECT		Euro 406
METAL ● Titanium M73		LMQ10573BSO
● Aluminium M79		LMQ10579BSO

MATT		Euro 382
● Nero G40		LGQ10540BSO
● Tortora G43		LGQ10543BSO
● Cemento G48		LGQ10548BSO
● Bianco G68		LGQ10568BSO
● Espresso G78		LGQ10578BSO

CLASSIC		Euro 382
● Avena G51		LGQ10551BSO
● Antracite G59		LGQ10559BSO
● Bianco Antico G62		LGQ10562BSO

QUADRA 102 SOTTOTOP



Tortora
G43

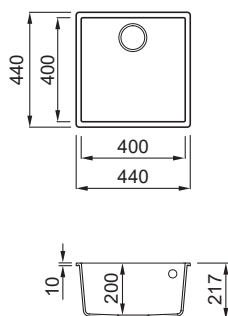

Lavello 1 vasca



CARATTERISTICHE

Dimensioni (mm) **440 x 440**
 Base (mm) **500**
 Foro da incasso (mm) **400 x 400 R5**
 Profondità Vasca (mm) **200**
 Installazione **Sottotop**
 Orientamento **Non reversibile**

ACCESSORI CONSIGLIATI

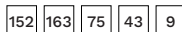

MATERIALI E COLORI

KERATEX GERAM: NANOTECHNOLOGY ONE		Euro 490
● Black K86		LKQ10286BSO
● Dove Grey K93		LKQ10293BSO
● Champagne K95		LKQ10295BSO
● White K96		LKQ10296BSO
● Light Grey K97		LKQ10297BSO
● Dark Grey K99		LKQ10299BSO

GRANITEK NATURAL GRANITE EFFECT

GRANITEK NATURAL GRANITE EFFECT		Euro 406
METAL ● Titanium M73		LMQ10273BSO
● Aluminium M79		LMQ10279BSO

MATT		Euro 382
● Nero G40		LGQ10240BSO
● Tortora G43		LGQ10243BSO
● Cemento G48		LGQ10248BSO
● Bianco G68		LGQ10268BSO
● Espresso G78		LGQ10278BSO

CLASSIC		Euro 382
● Avena G51		LGQ10251BSO
● Antracite G59		LGQ10259BSO
● Bianco Antico G62		LGQ10262BSO

QUADRA 100 SOTTOTOP



Bianco
G68

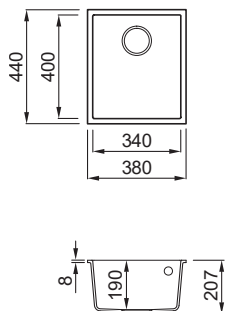

Lavello 1 vasca



CARATTERISTICHE

Dimensioni (mm) **380 x 440**
 Base (mm) **450**
 Foro da incasso (mm) **340 x 400 R5**
 Profondità Vasca (mm) **190**
 Installazione **Sottotop**
 Orientamento **Non reversibile**

ACCESSORI CONSIGLIATI

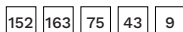

MATERIALI E COLORI

KERATEK GERMIC NANOTECHNOLOGY DNR		Euro 391
	Black K86	LKQ10086BSO
	Dove Grey K93	LKQ10093BSO
	Champagne K95	LKQ10095BSO
	White K96	LKQ10096BSO
	Light Grey K97	LKQ10097BSO
	Dark Grey K99	LKQ10099BSO

GRANITEK NATURAL GRANITE EFFECT		Euro 320
METAL	Titanium M73	LMQ10073BSO
	Aluminium M79	LMQ10079BSO

		Euro 308
MATT	Nero G40	LGQ10040BSO
	Tortora G43	LGQ10043BSO
	Cemento G48	LGQ10048BSO
	Bianco G68	LGQ10068BSO
	Espresso G78	LGQ10078BSO

		Euro 308
CLASSIC	Avena G51	LGQ10051BSO
	Antracite G59	LGQ10059BSO
	Bianco Antico G62	LGQ10062BSO

QUADRA 50 SOTTOTOP



Bianco
G68

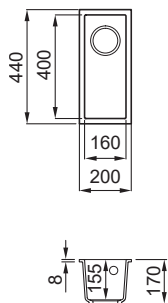

Lavello 1 vasca



CARATTERISTICHE

Dimensioni (mm) **200 x 440**
 Base (mm) **300**
 Foro da incasso (mm) **160 x 400 R5**
 Profondità Vasca (mm) **155**
 Installazione **Sottotop**
 Orientamento **Non reversibile**

ACCESSORI CONSIGLIATI



MATERIALI E COLORI

KERATEK GERMIC NANOTECHNOLOGY DNR		Euro 328
	Black K86	LKQ05086BSO
	Dove Grey K93	LKQ05093BSO
	Champagne K95	LKQ05095BSO
	White K96	LKQ05096BSO
	Light Grey K97	LKQ05097BSO
	Dark Grey K99	LKQ05099BSO

GRANITEK NATURAL GRANITE EFFECT		Euro 271
METAL	Titanium M73	LMQ05073BSO
	Aluminium M79	LMQ05079BSO

		Euro 258
MATT	Nero G40	LGQ05040BSO
	Tortora G43	LGQ05043BSO
	Cemento G48	LGQ05048BSO
	Bianco G68	LGQ05068BSO
	Espresso G78	LGQ05078BSO

		Euro 258
CLASSIC	Avena G51	LGQ05051BSO
	Antracite G59	LGQ05059BSO
	Bianco Antico G62	LGQ05062BSO

QUADRA 350 SOTTOTOP



Tortora
G43

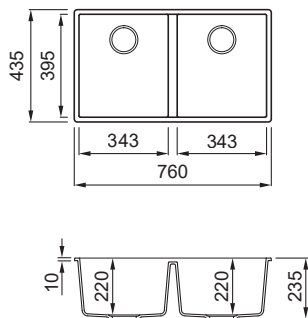

Lavello 2 vasche



CARATTERISTICHE

Dimensioni (mm) **760 x 435**
 Base (mm) **800**
 Foro da incasso (mm) **720 x 395 R5**
 Profondità Vasca 1 (mm) **220**
 Profondità Vasca 2 (mm) **220**
 Installazione **Sottotop**
 Orientamento **Non reversibile**

ACCESSORI CONSIGLIATI



MATERIALI E COLORI

KERATEK GERAMA NANOTECHNOLOGY ONE		Euro 618
● Black K86		LKQ35086BSO
● Dove Grey K93		LKQ35093BSO
● Champagne K95		LKQ35095BSO
● White K96		LKQ35096BSO
● Light Grey K97		LKQ35097BSO
● Dark Grey K99		LKQ35099BSO

GRANITEK NATURAL GRANITE EFFECT		Euro 516
METAL ● Titanium M73		LMQ35073BSO
METAL ● Aluminium M79		LMQ35079BSO

MATT		Euro 485
● Nero G40		LGQ35040BSO
● Tortora G43		LGQ35043BSO
● Cemento G48		LGQ35048BSO
● Bianco G68		LGQ35068BSO
● Espresso G78		LGQ35078BSO

CLASSIC		Euro 485
● Avena G51		LGQ35051BSO
● Antracite G59		LGQ35059BSO
● Bianco Antico G62		LGQ35062BSO

QUADRA 340 SOTTOTOP



Tortora
G43

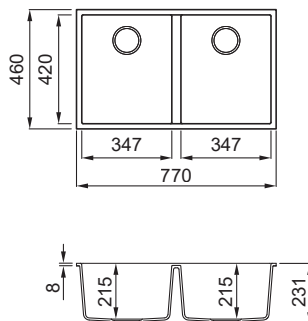

Lavello 2 vasche



CARATTERISTICHE

Dimensioni (mm) **770 x 460**
 Base (mm) **900**
 Foro da incasso (mm) **730 x 420 R5**
 Profondità Vasca 1 (mm) **215**
 Profondità Vasca 2 (mm) **215**
 Installazione **Sottotop**
 Orientamento **Non reversibile**

ACCESSORI CONSIGLIATI



MATERIALI E COLORI

GRANITEK NATURAL GRANITE EFFECT		Euro 565
METAL ● Titanium M73		LMQ34073BSC
METAL ● Aluminium M79		LMQ34079BSC

MATT		Euro 535
● Nero G40		LGQ34040BSC
● Tortora G43		LGQ34043BSC
● Bianco G68		LGQ34068BSC

CLASSIC		Euro 535
● Avena G51		LGQ34051BSC

QUADRA 440 SOTTOTOP



Bianco
G68

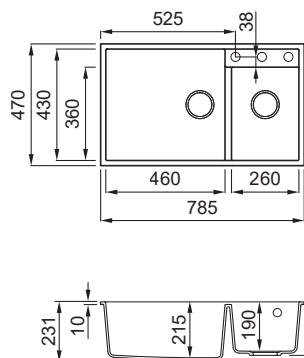

Lavello 2 vasche



CARATTERISTICHE

Dimensioni (mm)	785 x 470
Base (mm)	900
Foro da incasso (mm)	745 x 430 R5
Profondità Vasca 1 (mm)	215
Profondità Vasca 2 (mm)	190
Installazione	Sottotop
Orientamento	Non reversibile

ACCESSORI CONSIGLIATI

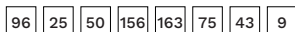

MATERIALI E COLORI

GRANITEK NATURAL GRANITE EFFECT		Euro 596
METAL	Titanium M73	LMQ44073BSO
	Aluminium M79	LMQ44079BSO
Euro 560		
MATT	Nero G40	LGQ44040BSO
	Tortora G43	LGQ44043BSO
	Bianco G68	LGQ44068BSO
Euro 560		
CLASSIC	Avena G51	LGQ44051BSO

QUADRA 150 SOTTOTOP



Bianco
G68

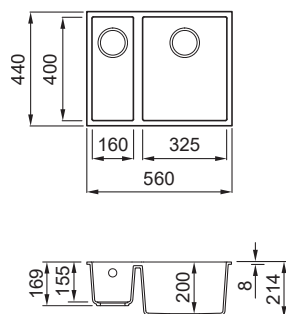

Lavello 2 vasche



CARATTERISTICHE

Dimensioni (mm)	560 x 440
Base (mm)	600
Foro da incasso (mm)	520 x 400 R5
Profondità Vasca 1 (mm)	200
Profondità Vasca 2 (mm)	155
Installazione	Sottotop
Orientamento	Non reversibile

ACCESSORI CONSIGLIATI

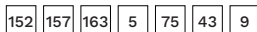

MATERIALI E COLORI

KERATEK CERAMIC NANOTECHNOLOGY ONE		Euro 538
METAL	Black K86	LKQ15086BSO
	Dove Grey K93	LKQ15093BSO
	Champagne K95	LKQ15095BSO
	White K96	LKQ15096BSO
	Light Grey K97	LKQ15097BSO
	Dark Grey K99	LKQ15099BSO
	Euro 440	
METAL	Titanium M73	LMQ15073BSO
	Aluminium M79	LMQ15079BSO
Euro 418		
MATT	Nero G40	LGQ15040BSO
	Tortora G43	LGQ15043BSO
	Cemento G48	LGQ15048BSO
	Bianco G68	LGQ15068BSO
	Espresso G78	LGQ15078BSO
Euro 418		
CLASSIC	Avena G51	LGQ15051BSO
	Antracite G59	LGQ15059BSO
	Bianco Antico G62	LGQ15062BSO

QUADRA 200 SOTTOTOP



Black
K86

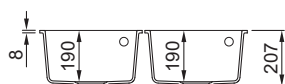
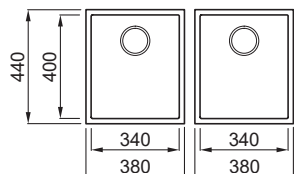

Lavello 2 vasche



CARATTERISTICHE

Dimensioni (mm) **380 x 440 + 380 x 440**
 Base (mm) **900**
 Foro da incasso (mm) **340 x 400 R5 + 340 x 400 R5 (distanza min 50 mm, max 200 mm)**
 Profondità Vasca 1 (mm) **190**
 Profondità Vasca 2 (mm) **190**
 Installazione **Sottotop**
 Orientamento **Non reversibile**

ACCESSORI CONSIGLIATI

- 152
- 157
- 163
- 75
- 43
- 9

MATERIALI E COLORI

KERATEK <small>CERAMIC NANOTECHNOLOGY ONE</small>		Euro 703
● Black K86		LKQ20086BSO
● Dove Grey K93		LKQ20093BSO
● Champagne K95		LKQ20095BSO
● White K96		LKQ20096BSO
● Light Grey K97		LKQ20097BSO
● Dark Grey K99		LKQ20099BSO

GRANITEK <small>NATURAL GRANITE EFFECT</small>		Euro 578
METAL ● Titanium M73		LMQ20073BSO
● Aluminium M79		LMQ20079BSO

MATT		Euro 553
● Nero G40		LGQ20040BSO
● Tortora G43		LGQ20043BSO
● Cemento G48		LGQ20048BSO
● Bianco G68		LGQ20068BSO
● Espresso G78		LGQ20078BSO

CLASSIC		Euro 553
● Avena G51		LGQ20051BSO
● Antracite G59		LGQ20059BSO
● Bianco Antico G62		LGQ20062BSO



Lavello Quadra 350 Sottotop Bianco G68 | Miscelatore Cloud Bianco G68



MAGGIORI
INFORMAZIONI
LINEA BEST



L'EFFICIENZA DELLE GEOMETRIE RAZIONALI

Best è la collezione di lavelli in composito dall'estetica razionale che permette il massimo dell'efficienza grazie al bordo salva goccia professional e allo scorrimento degli accessori lungo tutto il lavello. I lavelli Best dispongono di spartivasche maggiorato con area miscelatori integrata, per un utilizzo più completo.

PLUS BEST



ACCESSORI
ELEMENT



BORDO
SALVAGOCCIA



SPARTIVASCHE
MAGGIORATO



FLOW PRO

GRANITEK[®]
NATURAL GRANITE EFFECT

 **Titanium**
M73

 **Aluminium**
M79

 **Nero**
G40

 **Tortora**
G43

 **Cemento**
G48

 **Bianco**
G68

 **Espresso**
G78

 **Avena**
G51

 **Antracite**
G59

 **Bianco Antico**
G62

KERATEK[®]
CERAMIC NANOTECHNOLOGY CN6

 **Black**
K86

 **Dove Grey**
K93

 **Champagne**
K95

 **White**
K96

 **Light Grey**
K97

 **Dark Grey**
K99

I MODELLI BEST

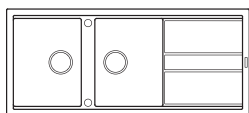

BEST **500**

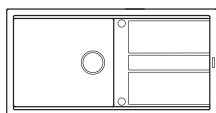

BEST **480**

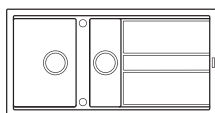

BEST **475**

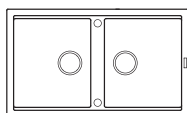

BEST **450**

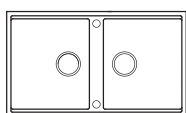

BEST **450 SOTTOTOP**

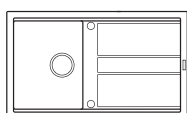

BEST **400**

Corredo del lavello: Sifone salvaspazio, piletta Flow Pro integrata, troppopieno rettangolare e ganci.

ACCESSORI CONSIGLIATI

89

**ELEMENT TAGLIERE
BEST LINE**
ATH0200L
Pag. **142**



Finiture

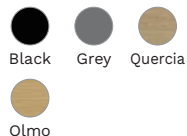

156

**ELEMENT DRAINER
FLEX 500**
ARS023BK
Pag. **144**



Finiture



5

COLANDER BEST

AVI03000
Pag. **150**



97

**ELEMENT POP-UP
PUSH CONTROL**
ASP13002BK
Pag. **147**



Finiture

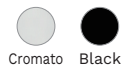

*Per ulteriori informazioni vai alla sezione accessori a pag. **140**

IL PERFETTO MATCH MISCELATORI



STREAM PLUS - Nero G40
MGKSTP40

Pag. **158**

Disponibile nelle colorazioni



OPTIONAL

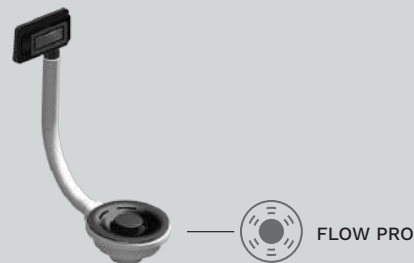

KIT ELEMENT
FLOW PRO + TROPPO PIENO BLACK
KITWPT-F-1VSL-L-BK

Pag. **146**

elleci | BEAUTY



Una linea di prodotti appositamente studiata per la cura dei lavelli in composito.

Scopri di più a pag. **200**

BEST 500



Dark Grey
K99

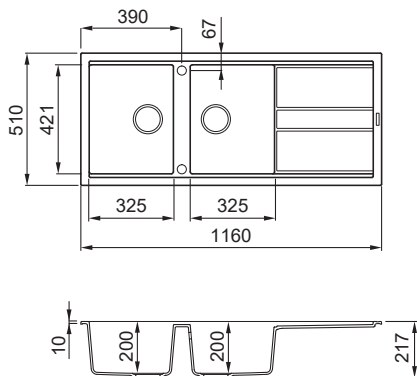

Lavello 2 vasche con gocciolatoio



CARATTERISTICHE

Dimensioni (mm) **1160 x 510**
 Base (mm) **800**
 Foro da incasso (mm) **1140 x 480**
 Profondità Vasca 1 (mm) **200**
 Profondità Vasca 2 (mm) **200**
 Installazione **Sopratop**
 Orientamento **Reversibile**

ACCESSORI CONSIGLIATI

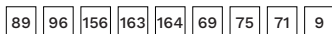

MATERIALI E COLORI

KERATEK GERMIC NANOTECHNOLOGY DMR		Euro 721
	Black K86	LKB50086
	Dove Grey K93	LKB50093
	Champagne K95	LKB50095
	White K96	LKB50096
	Light Grey K97	LKB50097
	Dark Grey K99	LKB50099

GRANITEK NATURAL GRANITE EFFECT		Euro 566
	Titanium M73	LMB50073
	Aluminium M79	LMB50079

MATT		Euro 538
	Nero G40	LGB50040
	Tortora G43	LGB50043
	Cemento G48	LGB50048
	Bianco G68	LGB50068
	Espresso G78	LGB50078

CLASSIC		Euro 538
	Avena G51	LGB50051
	Antracite G59	LGB50059
	Bianco Antico G62	LGB50062

BEST 480



Dark Grey
K99

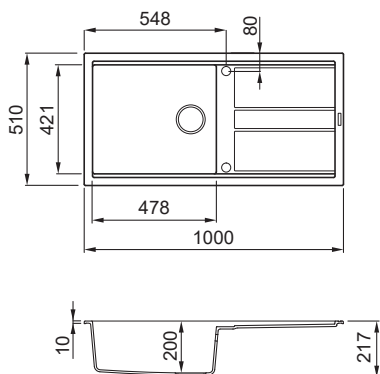

Lavello 1 vasca con gocciolatoio

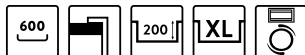

CARATTERISTICHE

Dimensioni (mm) **1000 x 510**
 Base (mm) **600**
 Foro da incasso (mm) **980 x 480**
 Profondità Vasca (mm) **200**
 Installazione **Sopratop**
 Orientamento **Reversibile**

ACCESSORI CONSIGLIATI

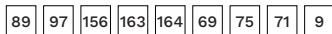

MATERIALI E COLORI

KERATEK GERMIC NANOTECHNOLOGY DMR		Euro 698
	Black K86	LKB48086
	Dove Grey K93	LKB48093
	Champagne K95	LKB48095
	White K96	LKB48096
	Light Grey K97	LKB48097
	Dark Grey K99	LKB48099

GRANITEK NATURAL GRANITE EFFECT		Euro 546
	Titanium M73	LMB48073
	Aluminium M79	LMB48079

MATT		Euro 524
	Nero G40	LGB48040
	Tortora G43	LGB48043
	Cemento G48	LGB48048
	Bianco G68	LGB48068
	Espresso G78	LGB48078

CLASSIC		Euro 524
	Avena G51	LGB48051
	Antracite G59	LGB48059
	Bianco Antico G62	LGB48062

BEST 475



White
K96

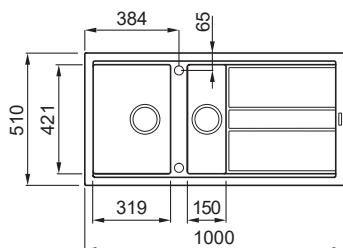

Lavello 1 vasca ½ con gocciolatoio



CARATTERISTICHE

Dimensioni (mm) **1000 x 510**
 Base (mm) **600**
 Foro da incasso (mm) **980 x 480**
 Profondità Vasca 1 (mm) **200**
 Profondità Vasca 2 (mm) **140**
 Installazione **Sopratop**
 Orientamento **Reversibile**

ACCESSORI CONSIGLIATI

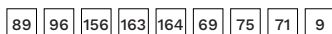

MATERIALI E COLORI

KERATEX GERAM: NANOTECHNOLOGY ONE		Euro 707
● Black K86		LKB47586
● Dove Grey K93		LKB47593
● Champagne K95		LKB47595
● White K96		LKB47596
● Light Grey K97		LKB47597
● Dark Grey K99		LKB47599

GRANITEK NATURAL GRANITE EFFECT		Euro 552
● Titanium M73		LMB47573
● Aluminium M79		LMB47579

METAL		
● Titanium M73		LMB47573
● Aluminium M79		LMB47579

MATT		Euro 527
● Nero G40		LGB47540
● Tortora G43		LGB47543
● Cemento G48		LGB47548
● Bianco G68		LGB47568
● Espresso G78		LGB47578

CLASSIC		Euro 527
● Avena G51		LGB47551
● Antracite G59		LGB47559
● Bianco Antico G62		LGB47562

BEST 400



White
K96

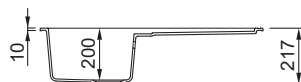
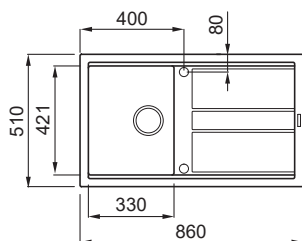

Lavello 1 vasca con gocciolatoio



CARATTERISTICHE

Dimensioni (mm) **860 x 510**
 Base (mm) **450**
 Foro da incasso (mm) **840 x 480**
 Profondità Vasca (mm) **200**
 Installazione **Sopratop**
 Orientamento **Reversibile**

ACCESSORI CONSIGLIATI

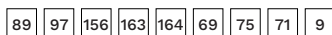

MATERIALI E COLORI

KERATEX GERAM: NANOTECHNOLOGY ONE		Euro 617
● Black K86		LKB40086
● Dove Grey K93		LKB40093
● Champagne K95		LKB40095
● White K96		LKB40096
● Light Grey K97		LKB40097
● Dark Grey K99		LKB40099

GRANITEK NATURAL GRANITE EFFECT		Euro 480
● Titanium M73		LMB40073
● Aluminium M79		LMB40079

METAL		
● Titanium M73		LMB40073
● Aluminium M79		LMB40079

MATT		Euro 454
● Nero G40		LGB40040
● Tortora G43		LGB40043
● Cemento G48		LGB40048
● Bianco G68		LGB40068
● Espresso G78		LGB40078

CLASSIC		Euro 454
● Avena G51		LGB40051
● Antracite G59		LGB40059
● Bianco Antico G62		LGB40062

BEST 450



Nero G40

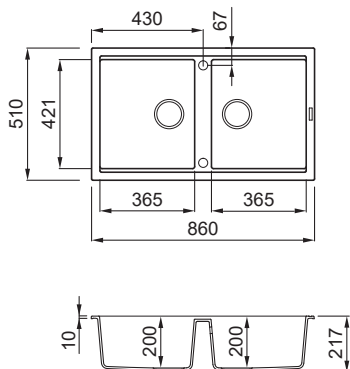

Lavello 2 vasche



CARATTERISTICHE

Dimensioni (mm) **860 x 510**
 Base (mm) **900**
 Foro da incasso (mm) **840 x 480**
 Profondità Vasca 1 (mm) **200**
 Profondità Vasca 2 (mm) **200**
 Installazione **Sopratop**
 Orientamento **Reversibile**

ACCESSORI CONSIGLIATI

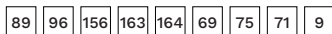

MATERIALI E COLORI

KERATEK GERMIC NANOTECHNOLOGY DNE		Euro 646
	Black K86	LKB45086
	Dove Grey K93	LKB45093
	Champagne K95	LKB45095
	White K96	LKB45096
	Light Grey K97	LKB45097
	Dark Grey K99	LKB45099

GRANITEK NATURAL GRANITE EFFECT		Euro 505
METAL	Titanium M73	LMB45073
	Aluminium M79	LMB45079

		Euro 483
MATT	Nero G40	LGB45040
	Tortora G43	LGB45043
	Cemento G48	LGB45048
	Bianco G68	LGB45068
	Espresso G78	LGB45078

		Euro 483
CLASSIC	Avena G51	LGB45051
	Antracite G59	LGB45059
	Bianco Antico G62	LGB45062

BEST 450 SOTTOTOP



Nero G40

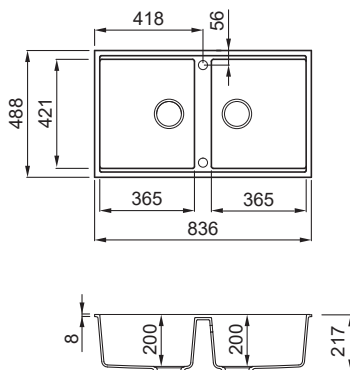

Lavello 2 vasche



CARATTERISTICHE

Dimensioni (mm) **836 x 488**
 Base (mm) **900**
 Foro da incasso (mm) **795 x 448 R6**
 Profondità Vasca 1 (mm) **200**
 Profondità Vasca 2 (mm) **200**
 Installazione **Sottotop**
 Orientamento **Reversibile**

ACCESSORI CONSIGLIATI

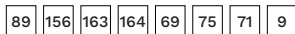

MATERIALI E COLORI

KERATEK GERMIC NANOTECHNOLOGY DNE		Euro 677
	Black K86	LKB45086BSO
	Dove Grey K93	LKB45093BSO
	Champagne K95	LKB45095BSO
	White K96	LKB45096BSO
	Light Grey K97	LKB45097BSO
	Dark Grey K99	LKB45099BSO

GRANITEK NATURAL GRANITE EFFECT		Euro 530
METAL	Titanium M73	LMB45073BSO
	Aluminium M79	LMB45079BSO

		Euro 507
MATT	Nero G40	LGB45040BSO
	Tortora G43	LGB45043BSO
	Cemento G48	LGB45048BSO
	Bianco G68	LGB45068BSO
	Espresso G78	LGB45078BSO

		Euro 507
CLASSIC	Avena G51	LGB45051BSO
	Antracite G59	LGB45059BSO
	Bianco Antico G62	LGB45062BSO



Lavello Best 480 Titanium M73 | Miscelatore Stream Cromato



MAGGIORI
INFORMAZIONI
LINEA UNICO



ELOGIO DELL'UNICITÀ

Unicità è una parola magica. Essere unici significa immaginare e creare prodotti e spazi che non c'erano, sentirsi meglio con sé stessi, provare strade mai percorse per tracciare una nuova rotta. La tua.

PLUS UNICO



VASCA XL





ACCESSORI
ELEMENT







AREA
ACCESSORI
INTEGRATA

GRANITEK® NATURAL GRANITE EFFECT

-  **Titanium**
M73
-  **Aluminium**
M79
-  **Nero**
G40
-  **Tortora**
G43
-  **Cemento**
G48
-  **Bianco**
G68
-  **Espresso**
G78

-  **Avena**
G51
-  **Antracite**
G59
-  **Bianco Antico**
G62

KERATEK® CERAMIC NANOTECHNOLOGY CN6

-  **Black**
K86
-  **Dove Grey**
K93
-  **White**
K96
-  **Light Grey**
K97

I MODELLI UNICO

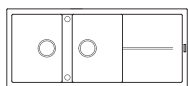

UNICO 500

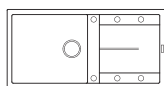

UNICO 480

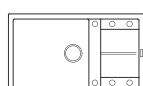

UNICO 410

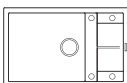

UNICO 310

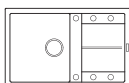

UNICO 300

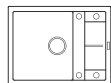

UNICO 125

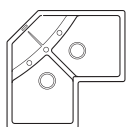

UNICO CORNER

Corredo del lavello: Sifone salvaspazio, troppopieno tondo, pilette e ganci.

ACCESSORI CONSIGLIATI

88

ELEMENT TAGLIERE SLIDING 50 CM

ATH010QU
Pag. 142



Finiture

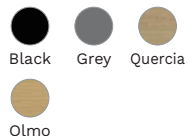

156

ELEMENT DRAINER FLEX 500

ARS023BK
Pag. 144



Finiture



97

ELEMENT POP-UP PUSH CONTROL

ASP13002BK
Pag. 147



Finiture



75

CESTELLO

ACI01307
Pag. 151



*Per ulteriori informazioni vai alla sezione accessori a pag. 140

IL PERFETTO MATCH MISCELATORI



TRAIL - Cemento G48

MGKTRA48

Pag. 159

Disponibile nelle colorazioni



OPTIONAL



KIT ELEMENT

ELEMENT POP UP PUSH CONTROL

ASP23002

Pag. 147

elleci | BEAUTY



Una linea di prodotti appositamente studiata per la cura dei lavelli in composito.

Scopri di più a pag. 200

UNICO 500



Titanium
M73

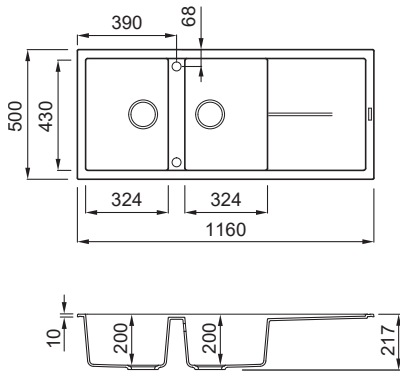

Lavello 2 vasche con gocciolatoio



CARATTERISTICHE

Dimensioni (mm) **1160 x 500**
 Base (mm) **800**
 Foro da incasso (mm) **1140 x 480**
 Profondità Vasca 1 (mm) **200**
 Profondità Vasca 2 (mm) **200**
 Installazione **Sopratop**
 Orientamento **Reversibile**

ACCESSORI CONSIGLIATI

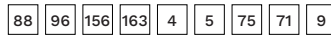

MATERIALI E COLORI

KERATEK GERMIC NANOTECHNOLOGY DNR		Euro 643
	Black K86	LKU50086
	Dove Grey K93	LKU50093
	White K96	LKU50096
	Light Grey K97	LKU50097

GRANITEK NATURAL GRANITE EFFECT		Euro 517
METAL		Titanium M73
		Aluminium M79

MATT		Nero G40	Euro 496	LGU50040
		Tortora G43	LGU50043	
		Cemento G48	LGU50048	
		Bianco G68	LGU50068	

CLASSIC		Espresso G78	LGU50078
		Avena G51	Euro 496 LGU50051
		Antracite G59	LGU50059

	Bianco Antico G62	LGU50062
--	-----------------------------	----------

UNICO 480



Titanium
M73

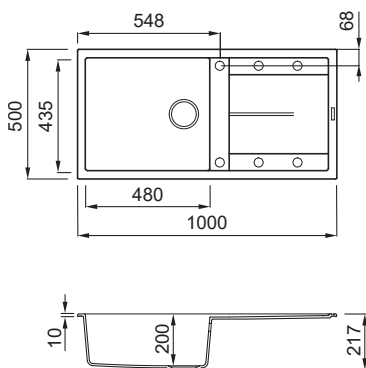

Lavello 1 vasca con gocciolatoio



CARATTERISTICHE

Dimensioni (mm) **1000 x 500**
 Base (mm) **600**
 Foro da incasso (mm) **980 x 480**
 Profondità Vasca (mm) **200**
 Installazione **Sopratop**
 Orientamento **Reversibile**

ACCESSORI CONSIGLIATI

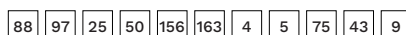

MATERIALI E COLORI

KERATEK GERMIC NANOTECHNOLOGY DNR		Euro 640
	Black K86	LKU48086
	Dove Grey K93	LKU48093
	White K96	LKU48096
	Light Grey K97	LKU48097

GRANITEK NATURAL GRANITE EFFECT		Euro 514
METAL		Titanium M73
		Aluminium M79

MATT		Nero G40	Euro 490	LGU48040
		Tortora G43	LGU48043	
		Cemento G48	LGU48048	
		Bianco G68	LGU48068	

CLASSIC		Espresso G78	LGU48078
		Avena G51	Euro 490 LGU48051
		Antracite G59	LGU48059

	Bianco Antico G62	LGU48062
--	-----------------------------	----------

UNICO 410



Aluminium
M79

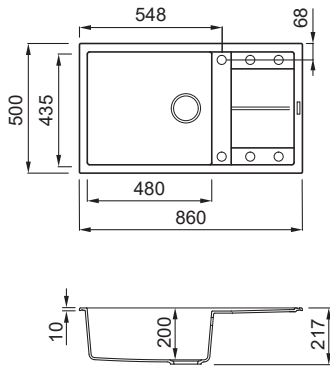

Lavello 1 vasca con gocciolatoio

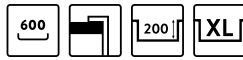

CARATTERISTICHE

Dimensioni (mm)	860 x 500
Base (mm)	600
Foro da incasso (mm)	840 x 480
Profondità Vasca (mm)	200
Installazione	Sopratop
Orientamento	Reversibile

ACCESSORI CONSIGLIATI

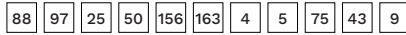

MATERIALI E COLORI

KERATEX <small>CERAMIC NANOTECHNOLOGY ONE</small>	Euro 567
Black K86	LKU41086
Dove Grey K93	LKU41093
White K96	LKU41096
Light Grey K97	LKU41097

GRANITEK <small>NATURAL GRANITE EFFECT</small>	Euro 454
METAL Titanium M73	LMU41073
Aluminium M79	LMU41079

MATT Nero G40	Euro 433 LGU41040
Tortora G43	LGU41043
Cemento G48	LGU41048
Bianco G68	LGU41068
Espresso G78	LGU41078

CLASSIC Avena G51	Euro 433 LGU41051
Antracite G59	LGU41059
Bianco Antico G62	LGU41062

UNICO 310



Aluminium
M79

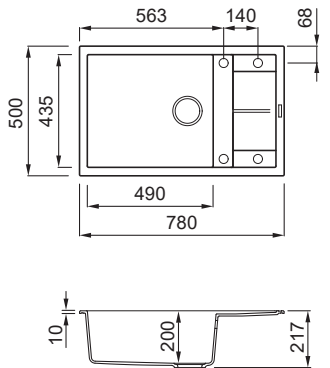

Lavello 1 vasca con gocciolatoio



CARATTERISTICHE

Dimensioni (mm)	780 x 500
Base (mm)	600 800 se inizio composizione
Foro da incasso (mm)	760 x 480
Profondità Vasca (mm)	200
Installazione	Sopratop
Orientamento	Reversibile

ACCESSORI CONSIGLIATI

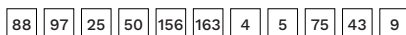

MATERIALI E COLORI

KERATEX <small>CERAMIC NANOTECHNOLOGY ONE</small>	Euro 567
Black K86	LKU31086
Dove Grey K93	LKU31093
White K96	LKU31096
Light Grey K97	LKU31097

GRANITEK <small>NATURAL GRANITE EFFECT</small>	Euro 454
METAL Titanium M73	LMU31073
Aluminium M79	LMU31079

MATT Nero G40	Euro 433 LGU31040
Tortora G43	LGU31043
Cemento G48	LGU31048
Bianco G68	LGU31068
Espresso G78	LGU31078

CLASSIC Avena G51	Euro 433 LGU31051
Antracite G59	LGU31059
Bianco Antico G62	LGU31062

UNICO 300



Nero G40

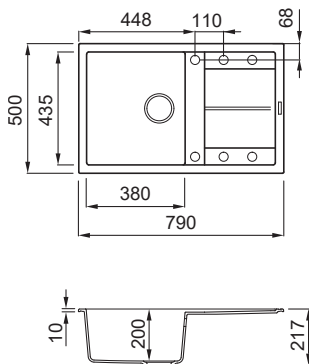

Lavello 1 vasca con gocciolatoio



CARATTERISTICHE

Dimensioni (mm) **790 x 500**
 Base (mm) **500**
 Foro da incasso (mm) **770 x 480**
 Profondità Vasca (mm) **200**
 Installazione **Sopratop**
 Orientamento **Reversibile**

ACCESSORI CONSIGLIATI

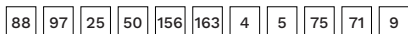

MATERIALI E COLORI

KERATEK GERAMIC NANOTECHNOLOGY DNR		Euro 554
	Black K86	LKU30086
	Dove Grey K93	LKU30093
	White K96	LKU30096
	Light Grey K97	LKU30097

GRANITEK NATURAL GRANITE EFFECT		Euro 444	
METAL		Titanium M73	LMU30073
		Aluminium M79	LMU30079

MATT		Nero G40	LGU30040
		Tortora G43	LGU30043
		Cemento G48	LGU30048
		Bianco G68	LGU30068

CLASSIC		Espresso G78	LGU30078
		Avena G51	LGU30051
		Antracite G59	LGU30059

		Bianco Antico G62	LGU30062
--	--	-----------------------------	----------

UNICO 125



Nero G40

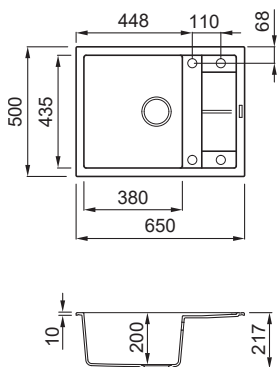

Lavello 1 vasca con gocciolatoio



CARATTERISTICHE

Dimensioni (mm) **650 x 500**
 Base (mm) **500**
 Foro da incasso (mm) **630 x 480**
 Profondità Vasca (mm) **200**
 Installazione **Sopratop**
 Orientamento **Reversibile**

ACCESSORI CONSIGLIATI

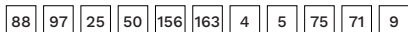

MATERIALI E COLORI

KERATEK GERAMIC NANOTECHNOLOGY DNR		Euro 512
	Black K86	LKU12586
	Dove Grey K93	LKU12593
	White K96	LKU12596
	Light Grey K97	LKU12597

GRANITEK NATURAL GRANITE EFFECT		Euro 411	
METAL		Titanium M73	LMU12573
		Aluminium M79	LMU12579

MATT		Nero G40	LGU12540
		Tortora G43	LGU12543
		Cemento G48	LGU12548
		Bianco G68	LGU12568

CLASSIC		Espresso G78	LGU12578
		Avena G51	LGU12551
		Antracite G59	LGU12559

		Bianco Antico G62	LGU12562
--	--	-----------------------------	----------

UNICO CORNER



Bianco
G68

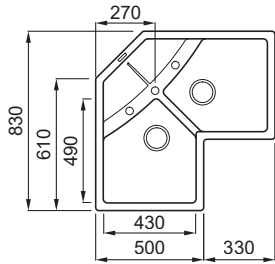

Lavello angolare 2 vasche con
gocciolatoio

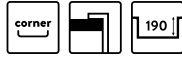

CARATTERISTICHE

Dimensioni (mm)	830 x 830
Base (mm)	Corner
Foro da incasso (mm)	Da dima*
Profondità Vasca 1 (mm)	190
Profondità Vasca 2 (mm)	190
Installazione	Sopratop
Orientamento	Reversibile

ACCESSORI CONSIGLIATI

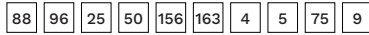

MATERIALI E COLORI

GRANITEK
NATURAL GRANITE EFFECT

METAL

- Titanium**
M73
- Aluminium**
M79

Euro **708**
LMUCOR73
LMUCOR79

MATT

- Nero**
G40
- Tortora**
G43
- Cemento**
G48
- Bianco**
G68
- Espresso**
G78

Euro **678**
LGUCOR40
LGUCOR43
LGUCOR48
LGUCOR68
LGUCOR78

CLASSIC

- Avena**
G51
- Antracite**
G59
- Bianco Antico**
G62

Euro **678**
LGUCOR51
LGUCOR59
LGUCOR62

*dima inclusa nella confezione o scaricabile dalla sezione download specifica del sito www.elleci.com/it



Lavello Unico Corner Nero G40 | Miscelatore Trail Plus Nero G40



MAGGIORI
INFORMAZIONI
LINEA EGO



DESIGN AVVOLGENTE

Una collezione di lavelli studiata per incontrare morbidi gusti. Le linee che la compongono sono molto leggere e formano delle curve che ne conferiscono un design avvolgente. Ogni modello è combinabile con numerosi accessori e molteplici colorazioni.

PLUS **EGO**



ACCESSORI
ELEMENT



DESIGN
AVVOLGENTE

GRANITEK[®]
NATURAL GRANITE EFFECT

- | | |
|---|---|
|  Titanium
M73 |  Avena
G51 |
|  Aluminium
M79 |  Antracite
G59 |
|  Nero
G40 |  Bianco Antico
G62 |
|  Tortora
G43 | |
|  Cemento
G48 | |
|  Bianco
G68 | |

I MODELLI EGO

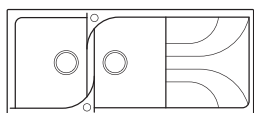

EGO 500

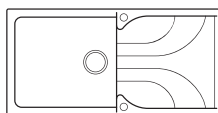

EGO 480

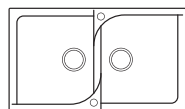

EGO 450

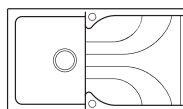

EGO 400

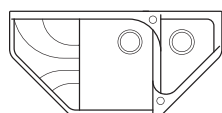

EGO ESA

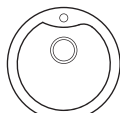

EGO ROUND

Corredo del lavello: Sifone salvaspazio, troppopieno tondo, pilette e ganci.

ACCESSORI CONSIGLIATI

88

ELEMENT TAGLIERE SLIDING 50 CM

ATH010QU
Pag. 142



Finiture

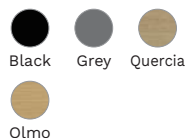

156

ELEMENT DRAINER FLEX 500

ARS023BK
Pag. 144



Finiture



96

ELEMENT POP-UP PUSH CONTROL 2 VIE

ASP23002
Pag. 147



Finiture

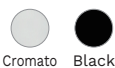

5

COLANDER

AVI03001
Pag. 150



*Per ulteriori informazioni vai alla sezione accessori a pag. 140

IL PERFETTO MATCH MISCELATORI



VOLTA - Titanium M73 MMKVTA73

Pag. 164

Disponibile nelle colorazioni



OPTIONAL



KIT ELEMENT ELEMENT POP UP PUSH CONTROL ASP23002

Pag. 147

elleci | BEAUTY



Una linea di prodotti appositamente studiata per la cura dei lavelli in composito.

Scopri di più a pag. 200

EGO 500



Nero G40

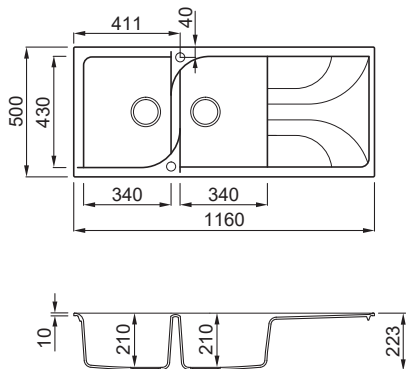

Lavello 2 vasche con gocciolatoio



CARATTERISTICHE

Dimensioni (mm) **1160 x 500**
 Base (mm) **800**
 Foro da incasso (mm) **1140 x 485**
 Profondità Vasca 1 (mm) **210**
 Profondità Vasca 2 (mm) **210**
 Installazione **Sopratop**
 Orientamento **Reversibile**

ACCESSORI CONSIGLIATI

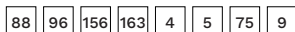

MATERIALI E COLORI

		GRANITEK NATURAL GRANITE EFFECT	Euro 496
METAL		Titanium M73	LME50073
		Aluminium M79	LME50079
			Euro 473
MATT		Nero G40	LGE50040
		Tortora G43	LGE50043
		Cemento G48	LGE50048
		Bianco G68	LGE50068
			Euro 473
CLASSIC		Avena G51	LGE50051
		Antracite G59	LGE50059
		Bianco Antico G62	LGE50062

EGO 480



Nero G40

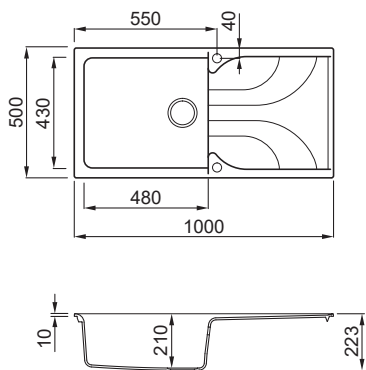

Lavello 1 vasca con gocciolatoio



CARATTERISTICHE

Dimensioni (mm) **1000 x 500**
 Base (mm) **600**
 Foro da incasso (mm) **980 x 485**
 Profondità Vasca (mm) **210**
 Installazione **Sopratop**
 Orientamento **Reversibile**

ACCESSORI CONSIGLIATI

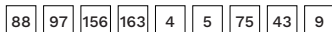

MATERIALI E COLORI

		GRANITEK NATURAL GRANITE EFFECT	Euro 490
METAL		Titanium M73	LME48073
		Aluminium M79	LME48079
			Euro 461
MATT		Nero G40	LGE48040
		Tortora G43	LGE48043
		Cemento G48	LGE48048
		Bianco G68	LGE48068
			Euro 461
CLASSIC		Avena G51	LGE48051
		Antracite G59	LGE48059
		Bianco Antico G62	LGE48062

EGO 400



Bianco
G68

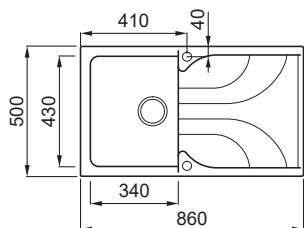

Lavello 1 vasca con gocciolatoio



CARATTERISTICHE

Dimensioni (mm)	860 x 500
Base (mm)	450
Foro da incasso (mm)	840 x 490
Profondità Vasca (mm)	210
Installazione	Sopratop
Orientamento	Reversibile

ACCESSORI CONSIGLIATI



MATERIALI E COLORI

GRANITEK
NATURAL GRANITE EFFECT

METAL

- Titanium M73
- Aluminium M79

Euro **424**
LME40073
LME40079

MATT

- Nero G40
- Tortora G43
- Cemento G48
- Bianco G68

Euro **406**
LGE40040
LGE40043
LGE40048
LGE40068

CLASSIC

- Avena G51
- Antracite G59
- Bianco Antico G62

Euro **406**
LGE40051
LGE40059
LGE40062

EGO 450



Bianco
G68

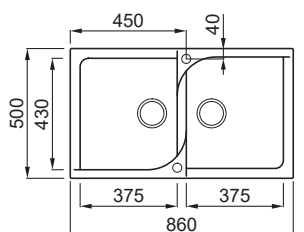

Lavello 2 vasche



CARATTERISTICHE

Dimensioni (mm)	860 x 500
Base (mm)	900
Foro da incasso (mm)	840 x 485
Profondità Vasca 1 (mm)	210
Profondità Vasca 2 (mm)	210
Installazione	Sopratop
Orientamento	Reversibile

ACCESSORI CONSIGLIATI

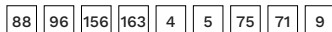

MATERIALI E COLORI

GRANITEK
NATURAL GRANITE EFFECT

METAL

- Titanium M73
- Aluminium M79

Euro **451**
LME45073
LME45079

MATT

- Nero G40
- Tortora G43
- Cemento G48
- Bianco G68

Euro **428**
LGE45040
LGE45043
LGE45048
LGE45068

CLASSIC

- Avena G51
- Antracite G59
- Bianco Antico G62

Euro **428**
LGE45051
LGE45059
LGE45062

EGO ROUND



Titanium M73

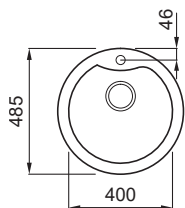

Lavello 1 vasca



CARATTERISTICHE

Dimensioni (mm)	Ø 485
Base (mm)	500
Foro da incasso (mm)	Ø 465
Profondità Vasca (mm)	210
Installazione	Sopratop
Orientamento	Non reversibile

ACCESSORI CONSIGLIATI



MATERIALI E COLORI

GRANITEK NATURAL GRANITE EFFECT		Euro 330
METAL	Titanium M73	LMEROU73
	Aluminium M79	LMEROU79
Euro 314		
MATT	Nero G40	LGEROU40
	Tortora G43	LGEROU43
	Bianco G68	LGEROU68
Euro 314		
CLASSIC	Avena G51	LGEROU51
	Antracite G59	LGEROU59
	Bianco Antico G62	LGEROU62

EGO ESA



Titanium M73

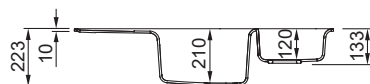
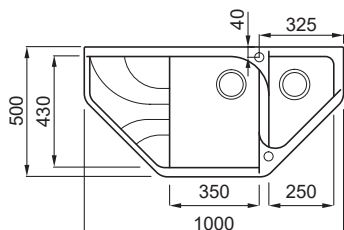

Lavello 2 vasche con gocciolatoio

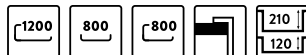

CARATTERISTICHE

Dimensioni (mm)	1000 x 500
Base (mm)	800 1200 se inizio composizione a sinistra 800 se inizio composizione a destra
Foro da incasso (mm)	Da dima*
Profondità Vasca 1 (mm)	210
Profondità Vasca 2 (mm)	120
Installazione	Sopratop
Orientamento	Non reversibile

ACCESSORI CONSIGLIATI

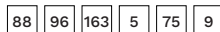

MATERIALI E COLORI

GRANITEK NATURAL GRANITE EFFECT		Euro 476
METAL	Titanium M73	LMEEA73
	Aluminium M79	LMEEA79
Euro 451		
MATT	Nero G40	LGEESA40
	Tortora G43	LGEESA43
	Bianco G68	LGEESA68
Euro 451		
CLASSIC	Avena G51	LGEESA51
	Antracite G59	LGEESA59
	Bianco Antico G62	LGEESA62

*dima inclusa nella confezione o scaricabile dalla sezione download specifica del sito www.elleci.com/it



Lavello Ego 450 Titanium M73 | Miscelatore Ares Titanium M73



MAGGIORI
INFORMAZIONI
LINEA EASY



L'ESSENZIALE SENZA TEMPO

Un prodotto unico dallo spiccato carattere innovativo che armonizza una funzionalità estrema con la capacità di poter "modellarsi" alle esigenze di chi lo utilizza fino a poter "scompare" del tutto.

PLUS **EASY**



VASCA XL



ACCESSORI
ELEMENT







PRISMA
CLEAN



DESIGN
ESSENZIALE

GRANITEK[®]
NATURAL GRANITE EFFECT

-  **Titanium**
M73
-  **Aluminium**
M79
-  **Nero**
G40
-  **Tortora**
G43
-  **Cemento**
G48
-  **Bianco**
G68
-  **Espresso**
G78

-  **Avena**
G51
-  **Antracite**
G59
-  **Bianco Antico**
G62

I MODELLI EASY

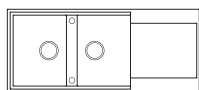

EASY 500

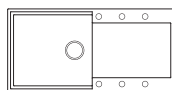

EASY 480

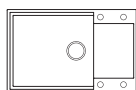

EASY 310

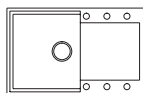

EASY 300

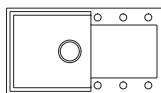

EASY 290

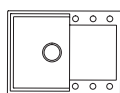

EASY 135

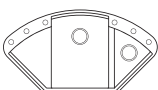

EASY CORNER

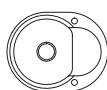

EASY 600 ROUND

Corredo del lavello: Sifone salvaspazio, troppopieno tondo, pilette e ganci.

ACCESSORI CONSIGLIATI

88

ELEMENT TAGLIERE SLIDING 50 CM

ATH010QU
Pag. 142



Finiture

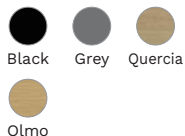

156

ELEMENT DRAINER FLEX 500

ARS023BK
Pag. 144



Finiture



97

ELEMENT POP-UP PUSH CONTROL

ASP13002BK
Pag. 147



Finiture



5

COLANDER

AVI03001
Pag. 150



*Per ulteriori informazioni vai alla sezione accessori a pag. 140

IL PERFETTO MATCH MISCELATORI



ATHENA - Tortora G43 MGKATH43

Pag. 161

Disponibile nelle colorazioni



OPTIONAL



KIT ELEMENT ELEMENT DISPENSER SAPONE TONDO ADIO2300

Pag. 145

elleci | BEAUTY



Una linea di prodotti appositamente studiata per la cura dei lavelli in composito.

Scopri di più a pag. 200

EASY 500



Nero G40

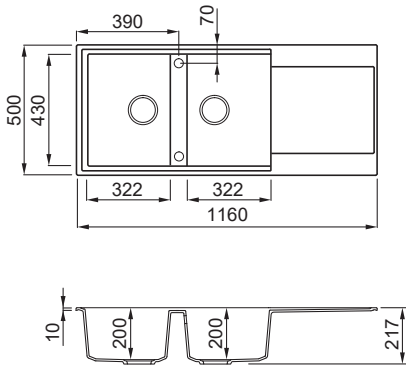

Lavello 2 vasche con gocciolatoio



CARATTERISTICHE

Dimensioni (mm)	1160 x 500
Base (mm)	800
Foro da incasso (mm)	1140 x 480
Profondità Vasca 1 (mm)	200
Profondità Vasca 2 (mm)	200
Installazione	Sopratop
Orientamento	Reversibile

ACCESSORI CONSIGLIATI

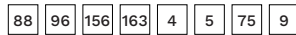

MATERIALI E COLORI

GRANITEK
NATURAL GRANITE EFFECT

METAL

- Titanium M73
- Aluminium M79

Euro **449**

LMY50073

LMY50079

MATT

- Nero G40
- Tortora G43
- Cemento G48
- Bianco G68
- Espresso G78

Euro **428**

LGY50040

LGY50043

LGY50048

LGY50068

LGY50078

CLASSIC

- Avena G51
- Antracite G59
- Bianco Antico G62

Euro **428**

LGY50051

LGY50059

LGY50062

EASY 480



Nero G40

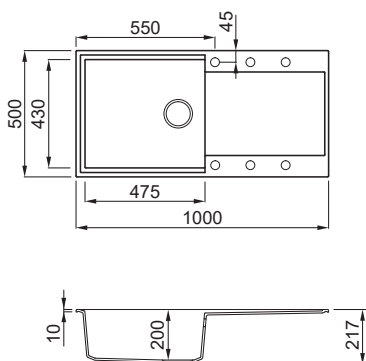

Lavello 1 vasca con gocciolatoio



CARATTERISTICHE

Dimensioni (mm)	1000 x 500
Base (mm)	600
Foro da incasso (mm)	980 x 480
Profondità Vasca (mm)	200
Installazione	Sopratop
Orientamento	Reversibile

ACCESSORI CONSIGLIATI

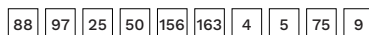

MATERIALI E COLORI

GRANITEK
NATURAL GRANITE EFFECT

METAL

- Titanium M73
- Aluminium M79

Euro **414**

LMY48073

LMY48079

MATT

- Nero G40
- Tortora G43
- Cemento G48
- Bianco G68
- Espresso G78

Euro **394**

LGY48040

LGY48043

LGY48048

LGY48068

LGY48078

CLASSIC

- Avena G51
- Antracite G59
- Bianco Antico G62

Euro **394**

LGY48051

LGY48059

LGY48062

EASY 310



Bianco
G68

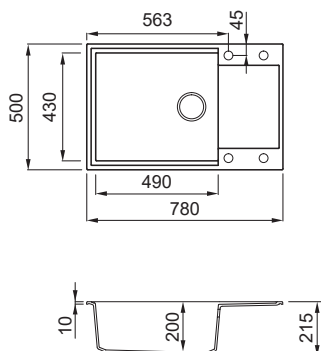

Lavello 1 vasca con gocciolatoio



CARATTERISTICHE

Dimensioni (mm)	780 x 500
Base (mm)	600 800 se inizio composizione
Foro da incasso (mm)	760 x 480
Profondità Vasca (mm)	200
Installazione	Sopratop
Orientamento	Reversibile

ACCESSORI CONSIGLIATI

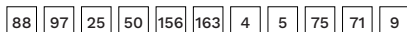

MATERIALI E COLORI

GRANITEK

NATURAL GRANITE EFFECT

METAL		Titanium M73	Euro 354 LMY31073
		Aluminium M79	LMY31079

MATT		Nero G40	Euro 337 LGY31040
		Tortora G43	LGY31043
		Cemento G48	LGY31048
		Bianco G68	LGY31068
		Espresso G78	LGY31078

CLASSIC		Avena G51	Euro 337 LGY31051
		Antracite G59	LGY31059
		Bianco Antico G62	LGY31062

EASY 300



Bianco
G68

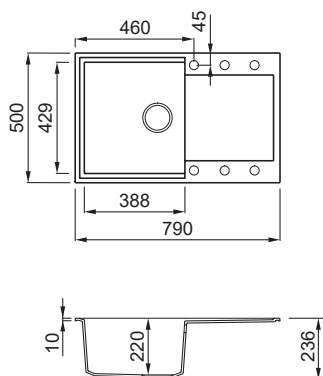

Lavello 1 vasca con gocciolatoio



CARATTERISTICHE

Dimensioni (mm)	790 x 500
Base (mm)	500 600 se inizio composizione
Foro da incasso (mm)	770 x 480
Profondità Vasca (mm)	220
Installazione	Sopratop
Orientamento	Reversibile

ACCESSORI CONSIGLIATI

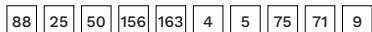

MATERIALI E COLORI

GRANITEK

NATURAL GRANITE EFFECT

METAL		Titanium M73	Euro 342 LMY30073
		Aluminium M79	LMY30079

MATT		Nero G40	Euro 326 LGY30040
		Tortora G43	LGY30043
		Cemento G48	LGY30048
		Bianco G68	LGY30068
		Espresso G78	LGY30078

CLASSIC		Avena G51	Euro 326 LGY30051
		Antracite G59	LGY30059
		Bianco Antico G62	LGY30062

EASY 290

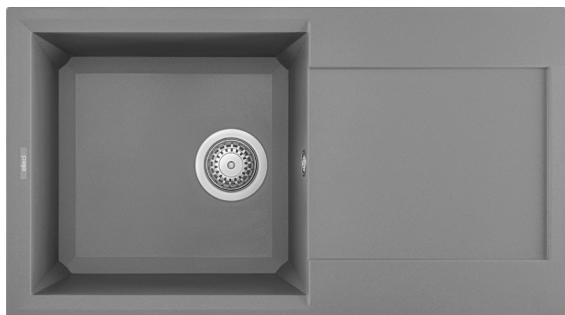

Titanium
M73

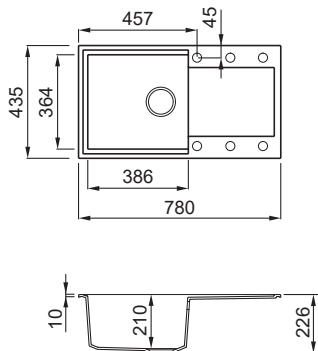

Lavello 1 vasca con gocciolatoio



CARATTERISTICHE

Dimensioni (mm) **780 x 435**
 Base (mm) **500 ||| 600 se inizio composizione**
 Foro da incasso (mm) **760 x 415**
 Profondità Vasca (mm) **210**
 Installazione **Sopratop**
 Orientamento **Reversibile**

ACCESSORI CONSIGLIATI

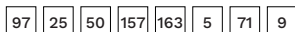

MATERIALI E COLORI



METAL

- Titanium**
M73
- Aluminium**
M79

Euro **342**
 LMY29073
 LMY29079

MATT

- Nero**
G40
- Tortora**
G43
- Cemento**
G48
- Bianco**
G68
- Espresso**
G78

Euro **326**
 LGY29040
 LGY29043
 LGY29048
 LGY29068
 LGY29078

CLASSIC

- Avena**
G51
- Antracite**
G59
- Bianco Antico**
G62

Euro **326**
 LGY29051
 LGY29059
 LGY29062

EASY 135

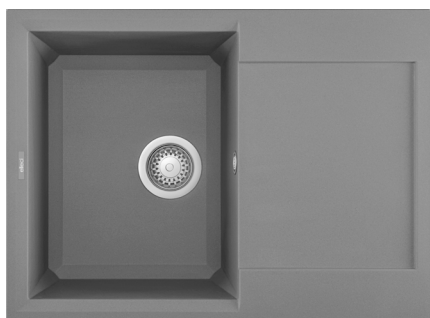

Titanium
M73

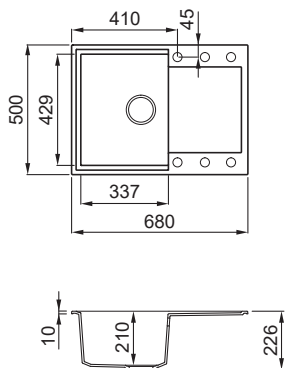

Lavello 1 vasca con gocciolatoio



CARATTERISTICHE

Dimensioni (mm) **680 x 500**
 Base (mm) **450 ||| 600 se inizio composizione**
 Foro da incasso (mm) **660 x 480**
 Profondità Vasca (mm) **210**
 Installazione **Sopratop**
 Orientamento **Reversibile**

ACCESSORI CONSIGLIATI

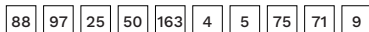

MATERIALI E COLORI



METAL

- Titanium**
M73
- Aluminium**
M79

Euro **291**
 LMY13573
 LMY13579

MATT

- Nero**
G40
- Tortora**
G43
- Cemento**
G48
- Bianco**
G68
- Espresso**
G78

Euro **277**
 LGY13540
 LGY13543
 LGY13548
 LGY13568
 LGY13578

CLASSIC

- Avena**
G51
- Antracite**
G59
- Bianco Antico**
G62

Euro **277**
 LGY13551
 LGY13559
 LGY13562

EASY CORNER



Aluminium M79

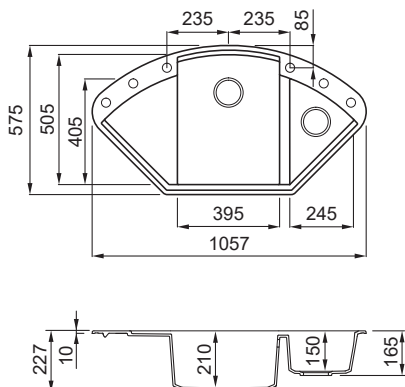

Lavello angolare 1 vasca ½ con gocciolatoio



CARATTERISTICHE

Dimensioni (mm)
Base (mm)

1057 x 575
Corner ||| 800 ||| 1200 se inizio comp. a sx || 800 se inizio comp. a dx (Top minimo 650 mm)
Da dima*
210
150
Sopratop
Non reversibile

Foro da incasso (mm)
Profondità Vasca 1 (mm)
Profondità Vasca 2 (mm)
Installazione
Orientamento

ACCESSORI CONSIGLIATI

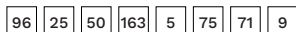

MATERIALI E COLORI

GRANITEK
NATURAL GRANITE EFFECT

METAL

- Titanium M73
- Aluminium M79

Euro **476**
LMYC0R73
LMYC0R79

MATT

- Nero G40
- Tortora G43
- Cemento G48
- Bianco G68
- Espresso G78

Euro **451**
LGYC0R40
LGYC0R43
LGYC0R48
LGYC0R68
LGYC0R78

CLASSIC

- Avena G51
- Antracite G59
- Bianco Antico G62

Euro **451**
LGYC0R51
LGYC0R59
LGYC0R62

*dima inclusa nella confezione o scaricabile dalla sezione download specifica del sito www.elleci.com/it

EASY 600 ROUND



Aluminium M79

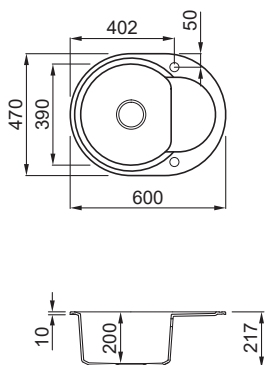

Lavello 1 vasca con gocciolatoio



CARATTERISTICHE

Dimensioni (mm)
Base (mm)
Foro da incasso (mm)
Profondità Vasca (mm)
Installazione
Orientamento

600 x 470
450
Da dima*
200
Sopratop
Reversibile

ACCESSORI CONSIGLIATI

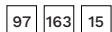

MATERIALI E COLORI

GRANITEK
NATURAL GRANITE EFFECT

METAL

- Titanium M73
- Aluminium M79

Euro **280**
LMYR6073
LMYR6079

MATT

- Nero G40
- Tortora G43
- Cemento G48
- Bianco G68
- Espresso G78

Euro **266**
LGYR6040
LGYR6043
LGYR6048
LGYR6068
LGYR6078

CLASSIC

- Avena G51
- Antracite G59
- Bianco Antico G62

Euro **266**
LGYR6051
LGYR6059
LGYR6062

*dima inclusa nella confezione o scaricabile dalla sezione download specifica del sito www.elleci.com/it



MAGGIORI
INFORMAZIONI
LINEA LIFE



EVERYDAY LIFE

Il classico incontra il moderno attraverso forme e linee discrete, morbide ed essenziali.
L'estetica mette al centro la propria essenza, funzionalità concreta di ciò che è importante nell'uso quotidiano.

PLUS **LIFE**



ACCESSORI
ELEMENT





VASCA CON
ANGOLI
ARROTONDATI



DESIGN
ESSENZIALE

GRANITEK[®]
NATURAL GRANITE EFFECT

-  **Titanium**
M73
-  **Aluminium**
M79
-  **Nero**
G40
-  **Tortora**
G43
-  **Cemento**
G48
-  **Bianco**
G68
-  **Espresso**
G78

-  **Avena**
G51
-  **Antracite**
G59
-  **Bianco Antico**
G62

I MODELLI LIFE

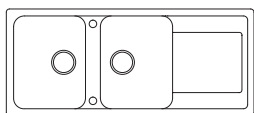

LIFE 500

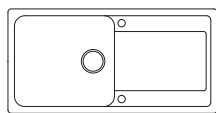

LIFE 480

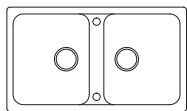

LIFE 450

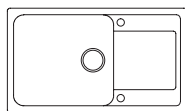

LIFE 410

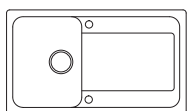

LIFE 400

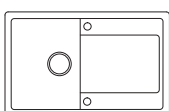

LIFE 300

Corredo del lavello: Sifone salvaspazio, troppopieno tondo, pilette e ganci.

ACCESSORI CONSIGLIATI

88

**ELEMENT TAGLIERE
SLIDING 50 CM**
ATH010BK
Pag. 142



Finiture

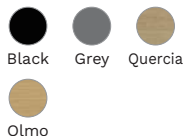

71

BOTTOM GRID S

AGB01306
Pag. 150



IL PERFETTO MATCH MISCELATORI



TRAIL PLUS - Cromato CR
MIKTRPCR

Pag. 159

Disponibile nelle colorazioni



OPTIONAL



KIT ELEMENT
ELEMENT DISPENSER SAPONE TONDO
ADIO2300

Pag. 145

elleci | BEAUTY



Una linea di prodotti appositamente studiata per la cura dei lavelli in composito.

Scopri di più a pag. 200

*Per ulteriori informazioni vai alla sezione accessori a pag. 140

LIFE 500 NEW



Bianco
G68

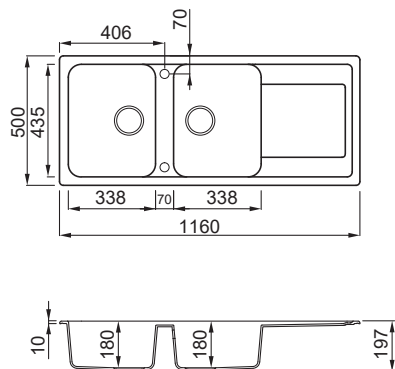

Lavello 2 vasche con gocciolatoio



CARATTERISTICHE

Dimensioni (mm) **1160 x 500**
 Base (mm) **800 ||| 900 se inizio composizione**
 Foro da incasso (mm) **1140 x 480**
 Profondità Vasca 1 (mm) **180**
 Profondità Vasca 2 (mm) **180**
 Installazione **Sopratop**
 Orientamento **Reversibile**

MATERIALI E COLORI

		GRANITEK <small>NATURAL GRANITE EFFECT</small>	Euro 413
METAL		Titanium M73	LM250073
		Aluminium M79	LM250079
			Euro 398
MATT		Nero G40	LG250040
		Tortora G43	LG250043
		Cemento G48	LG250048
		Bianco G68	LG250068
		Espresso G78	LG250078
			Euro 398
CLASSIC		Avena G51	LG250051
		Antracite G59	LG250059
		Bianco Antico G62	LG250062

LIFE 480 NEW



Bianco
G68

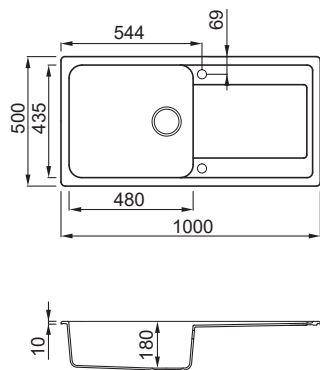

Lavello 1 vasca con gocciolatoio



CARATTERISTICHE

Dimensioni (mm) **1000 x 500**
 Base (mm) **600**
 Foro da incasso (mm) **980 x 480**
 Profondità Vasca (mm) **180**
 Installazione **Sopratop**
 Orientamento **Reversibile**

MATERIALI E COLORI

		GRANITEK <small>NATURAL GRANITE EFFECT</small>	Euro 411
METAL		Titanium M73	LM248073
		Aluminium M79	LM248079
			Euro 393
MATT		Nero G40	LG248040
		Tortora G43	LG248043
		Cemento G48	LG248048
		Bianco G68	LG248068
		Espresso G78	LG248078
			Euro 393
CLASSIC		Avena G51	LG248051
		Antracite G59	LG248059
		Bianco Antico G62	LG248062

LIFE 410 **NEW**



Cemento
G48

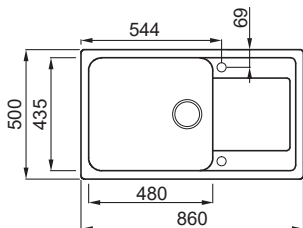

Lavello 1 vasca con gocciolatoio



CARATTERISTICHE

Dimensioni (mm)	860 x 500
Base (mm)	600
Foro da incasso (mm)	840 x 480
Profondità Vasca (mm)	180
Installazione	Sopratop
Orientamento	Reversibile

MATERIALI E COLORI

GRANITEK
NATURAL GRANITE EFFECT

METAL

- Titanium**
M73
- Aluminium**
M79

Euro **411**
LM241073
LM241079

MATT

- Nero**
G40
- Tortora**
G43
- Cemento**
G48
- Bianco**
G68
- Espresso**
G78

Euro **393**
LG241040
LG241043
LG241048
LG241068
LG241078

CLASSIC

- Avena**
G51
- Antracite**
G59
- Bianco Antico**
G62

Euro **393**
LG241051
LG241059
LG241062

LIFE 400 **NEW**



Cemento
G48

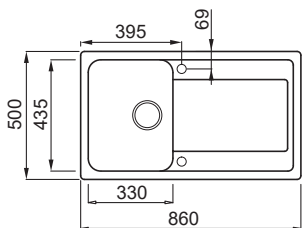

Lavello 1 vasca con gocciolatoio



CARATTERISTICHE

Dimensioni (mm)	860 x 500
Base (mm)	450
Foro da incasso (mm)	840 x 480
Profondità Vasca (mm)	180
Installazione	Sopratop
Orientamento	Reversibile

MATERIALI E COLORI

GRANITEK
NATURAL GRANITE EFFECT

METAL

- Titanium**
M73
- Aluminium**
M79

Euro **360**
LM240073
LM240079

MATT

- Nero**
G40
- Tortora**
G43
- Cemento**
G48
- Bianco**
G68
- Espresso**
G78

Euro **348**
LG240040
LG240043
LG240048
LG240068
LG240078

CLASSIC

- Avena**
G51
- Antracite**
G59
- Bianco Antico**
G62

Euro **348**
LG240051
LG240059
LG240062

LIFE 300 NEW



Tortora
G43

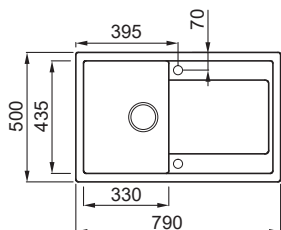

Lavello 1 vasca con gocciolatoio



CARATTERISTICHE

Dimensioni (mm) **790 x 500**
 Base (mm) **450**
 Foro da incasso (mm) **770 x 480**
 Profondità Vasca (mm) **180**
 Installazione **Sopratop**
 Orientamento **Reversibile**

MATERIALI E COLORI

GRANITEK
NATURAL GRANITE EFFECT

METAL

- Titanium**
M73
- Aluminium**
M79

Euro **360**
LM230073
LM230079

MATT

- Nero**
G40
- Tortora**
G43
- Cemento**
G48
- Bianco**
G68
- Espresso**
G78

Euro **348**
LG230040
LG230043
LG230048
LG230068
LG230078

CLASSIC

- Avena**
G51
- Antracite**
G59
- Bianco Antico**
G62

Euro **348**
LG230051
LG230059
LG230062

LIFE 450 NEW



Tortora
G43

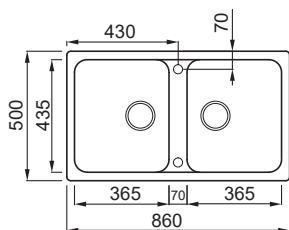

Lavello 2 vasche



CARATTERISTICHE

Dimensioni (mm) **860 x 500**
 Base (mm) **900**
 Foro da incasso (mm) **840 x 480**
 Profondità Vasca 1 (mm) **180**
 Profondità Vasca 2 (mm) **180**
 Installazione **Sopratop**
 Orientamento **Reversibile**

MATERIALI E COLORI

GRANITEK
NATURAL GRANITE EFFECT

METAL

- Titanium**
M73
- Aluminium**
M79

Euro **381**
LM245073
LM245079

MATT

- Nero**
G40
- Tortora**
G43
- Cemento**
G48
- Bianco**
G68
- Espresso**
G78

Euro **367**
LG245040
LG245043
LG245048
LG245068
LG245078

CLASSIC

- Avena**
G51
- Antracite**
G59
- Bianco Antico**
G62

Euro **367**
LG245051
LG245059
LG245062



Lavello Life 480 Espresso G78 | Miscelatore Trail Cromato



MAGGIORI
INFORMAZIONI
LINEA FOX



VERSATILITÀ E PRATICITÀ

Una collezione di lavelli molto versatile. Si adatta perfettamente ad ogni tipologia di spazio a disposizione sul top da cucina. Ogni modello è combinabile con numerosi accessori e molteplici colorazioni.

PLUS FOX



VASCA CON
ANGOLI
ARROTONDATI



ACCESSORI
ELEMENT

GRANITEK[®]
NATURAL GRANITE EFFECT

● **Titanium**
M73

● **Aluminium**
M79

● **Nero**
G40

○ **Bianco**
G68

● **Avena**
G51

● **Antracite**
G59

● **Bianco Antico**
G62

I MODELLI FOX

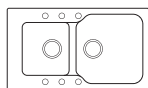

FOX 430

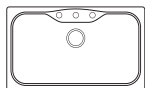

FOX 360

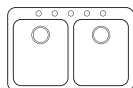

FOX 340

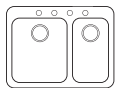

FOX 330



FOX 200

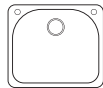

FOX 180



FOX ROUND

Corredo del lavello: Sifone salvaspazio, troppopieno tondo, pilette e ganci.

ACCESSORI CONSIGLIATI

88

ELEMENT TAGLIERE SLIDING 50 CM

ATH010QU
Pag. 142



Finiture

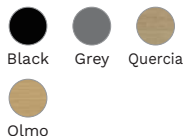

156

ELEMENT DRAINER FLEX 500

ARS023BK
Pag. 144



Finiture



155

ELEMENT TAGLIERE FOX 360

ATH130OL
Pag. 143



Finiture



11

CESTELLO FOX 360

ACI03300
Pag. 151



*Per ulteriori informazioni vai alla sezione accessori a pag. 140

IL PERFETTO MATCH MISCELATORI



CHEF - Cromato CR MIKCHECR

Pag. 156

Disponibile nelle colorazioni

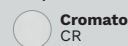

OPTIONAL



KIT ELEMENT

ELEMENT DISPENSER SAPONE TONDO ADIO2300

Pag. 145

elleci | BEAUTY



Una linea di prodotti appositamente studiata per la cura dei lavelli in composito.

Scopri di più a pag. 200

FOX 360



Avena
G51

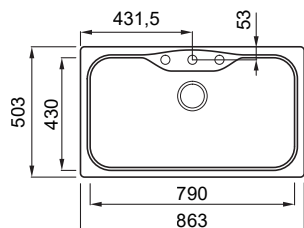

Lavello 1 vasca



CARATTERISTICHE

Dimensioni (mm)	863 x 503
Base (mm)	900
Foro da incasso (mm)	840 x 490
Profondità Vasca (mm)	225
Installazione	Sopratop
Orientamento	Non reversibile

ACCESSORI CONSIGLIATI

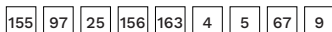

MATERIALI E COLORI

GRANITEK NATURAL GRANITE EFFECT		Euro 432
METAL	Titanium M73	LMF36073
	Aluminium M79	LMF36079
Euro 412		
MATT	Nero G40	LGF36040
	Bianco G68	LGF36068
Euro 412		
CLASSIC	Avena G51	LGF36051
	Antracite G59	LGF36059
	Bianco Antico G62	LGF36062

FOX 200



Bianco Antico
G62

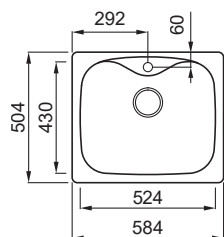

Lavello 1 vasca



CARATTERISTICHE

Dimensioni (mm)	584 x 504
Base (mm)	600
Foro da incasso (mm)	560 x 480 R32
Profondità Vasca (mm)	230
Installazione	Sopratop
Orientamento	Non reversibile

ACCESSORI CONSIGLIATI

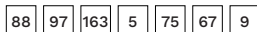

MATERIALI E COLORI

GRANITEK NATURAL GRANITE EFFECT		Euro 394
METAL	Titanium M73	LMF20073
	Aluminium M79	LMF20079
Euro 371		
MATT	Nero G40	LGF20040
	Bianco G68	LGF20068
Euro 371		
CLASSIC	Avena G51	LGF20051
	Antracite G59	LGF20059
	Bianco Antico G62	LGF20062

FOX 180

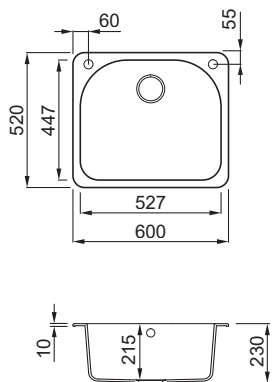
Avena
G51

Lavello 1 vasca

**CARATTERISTICHE**

Dimensioni (mm)	600 x 520
Base (mm)	600
Foro da incasso (mm)	580 x 510 R32
Profondità Vasca (mm)	215
Installazione	Sopratop
Orientamento	Non reversibile

ACCESSORI CONSIGLIATI**MATERIALI E COLORI****GRANITEK**
NATURAL GRANITE EFFECT

MATT

Euro **407**
LGF18040BTP
LGF18068BTP

CLASSIC

Euro **407**
LGF18051BTP
LGF18059BTP
LGF18062BTP

FOX ROUND

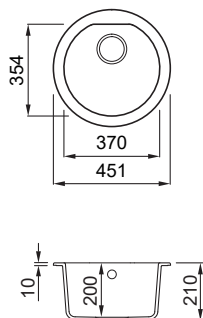
Avena
G51

Lavello 1 vasca

**CARATTERISTICHE**

Dimensioni (mm)	Ø 451
Base (mm)	450
Foro da incasso (mm)	Ø 430
Profondità Vasca (mm)	200
Installazione	Sopratop
Orientamento	Non reversibile

ACCESSORI CONSIGLIATI**MATERIALI E COLORI****GRANITEK**
NATURAL GRANITE EFFECT

MATT

Euro **302**
LGFROU40
LGFROU68

CLASSIC

Euro **302**
LGFROU51
LGFROU59
LGFROU62

FOX 430



Bianco
G68

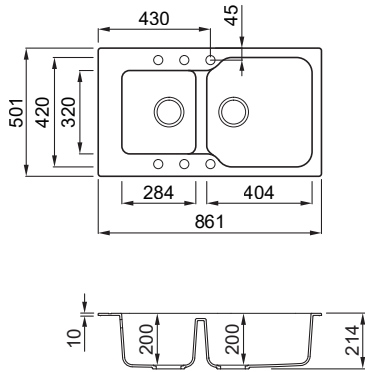

Lavello 2 vasche

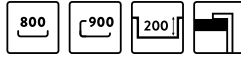

CARATTERISTICHE

Dimensioni (mm) **861 x 501**
 Base (mm) **800 ||| 900 se inizio composizione**
 Foro da incasso (mm) **840 x 490**
 Profondità Vasca 1 (mm) **200**
 Profondità Vasca 2 (mm) **200**
 Installazione **Sopratop**
 Orientamento **Reversibile**

ACCESSORI CONSIGLIATI

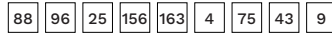

MATERIALI E COLORI

		GRANITEK <small>NATURAL GRANITE EFFECT</small>	Euro 407
MATT		Nero G40	LGF43040
		Bianco G68	LGF43068
			Euro 407
CLASSIC		Avena G51	LGF43051
		Antracite G59	LGF43059
		Bianco Antico G62	LGF43062

FOX 340



Bianco
G68

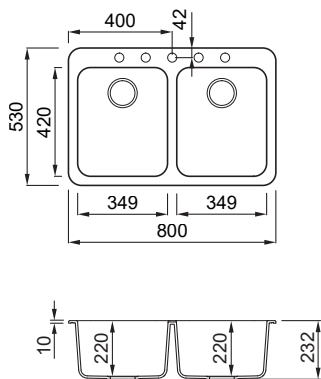

Lavello 2 vasche



CARATTERISTICHE

Dimensioni (mm) **800 x 530**
 Base (mm) **800 ||| 900 se inizio composizione**
 Foro da incasso (mm) **780 x 520 R32**
 Profondità Vasca 1 (mm) **220**
 Profondità Vasca 2 (mm) **220**
 Installazione **Sopratop**
 Orientamento **Non reversibile**

ACCESSORI CONSIGLIATI

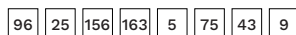

MATERIALI E COLORI

		GRANITEK <small>NATURAL GRANITE EFFECT</small>	Euro 394
MATT		Nero G40	LGF34040BTP
		Bianco G68	LGF34068BTP
			Euro 394
CLASSIC		Avena G51	LGF34051BTP
		Antracite G59	LGF34059BTP
		Bianco Antico G62	LGF34062BTP

FOX 330



Nero G40

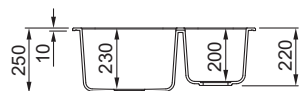
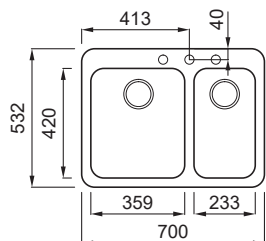

Lavello 2 vasche



CARATTERISTICHE

Dimensioni (mm)	700 x 532
Base (mm)	800
Foro da incasso (mm)	680 x 520 R32
Profondità Vasca 1 (mm)	230
Profondità Vasca 2 (mm)	200
Installazione	Sopratop
Orientamento	Non reversibile

ACCESSORI CONSIGLIATI



MATERIALI E COLORI

GRANITEK
NATURAL GRANITE EFFECT

MATT



Euro **376**
LGF33040BTP
LGF33068BTP

CLASSIC



Euro **376**
LGF33051BTP
LGF33059BTP
LGF33062BTP



Lavello Fox 360 Avena G51 | Miscelatore Reno Avena G51 | Tagliere Fox 360 Quercia



MAGGIORI
INFORMAZIONI
LINEA MASTER



LO STILE COUNTRY SENZA TEMPO

Una collezione di lavelli dal design country, perfetto per chi preferisce un ambiente caldo e classico ma con una forte personalità. Ogni modello è combinabile con numerosi accessori e molteplici colorazioni.

PLUS MASTER



VASCA CON
ANGOLI
ARROTONDATI



ACCESSORI
ELEMENT

GRANITEK[®]
NATURAL GRANITE EFFECT

● **Nero**
G40

○ **Bianco**
G68

● **Avena**
G51

● **Antracite**
G59

● **Bianco Antico**
G62

I MODELLI MASTER

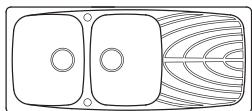

MASTER 500

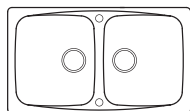

MASTER 450

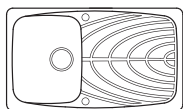

MASTER 400

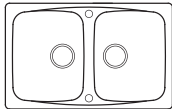

MASTER 350

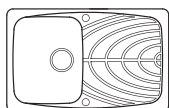

MASTER 300

Corredo del lavello: Sifone salvaspazio, troppopieno tondo, pilette e ganci.

ACCESSORI CONSIGLIATI

88

ELEMENT TAGLIERE SLIDING 50 CM

ATH010QU
Pag. 142



Finiture

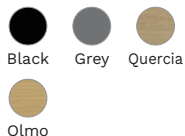

156

ELEMENT DRAINER FLEX 500

ARS023BK
Pag. 144



Finiture



5

COLANDER

AVI03001
Pag. 150



75

CESTELLO

ACI01307
Pag. 151



*Per ulteriori informazioni vai alla sezione accessori a pag. 140

IL PERFETTO MATCH MISCELATORI



DANUBIO - Bianco G68 MGKDAN68

Pag. 165

Disponibile nelle colorazioni



OPTIONAL



KIT ELEMENT ELEMENT POP UP PUSH CONTROL ASP23002

Pag. 147

elleci | BEAUTY



Una linea di prodotti appositamente studiata per la cura dei lavelli in composito.

Scopri di più a pag. 200

MASTER 500



Avena
G51

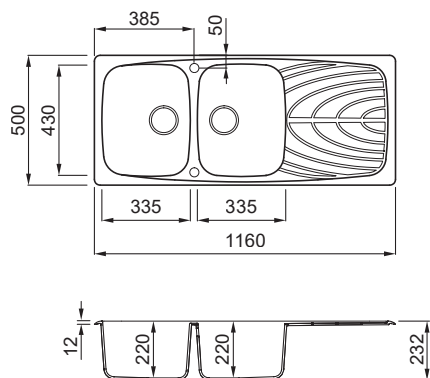

Lavello 2 vasche con gocciolatoio



CARATTERISTICHE

Dimensioni (mm)	1160 x 500
Base (mm)	800
Foro da incasso (mm)	1140 x 480
Profondità Vasca 1 (mm)	220
Profondità Vasca 2 (mm)	220
Installazione	Sopratop
Orientamento	Reversibile

ACCESSORI CONSIGLIATI

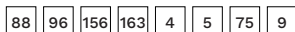

MATERIALI E COLORI

MATT	Nero G40	Euro 428 LGM50040
	Bianco G68	LGM50068
	Euro 428	
CLASSIC	Avena G51	LGM50051
	Antracite G59	LGM50059
	Bianco Antico G62	LGM50062

MASTER 400



Avena
G51

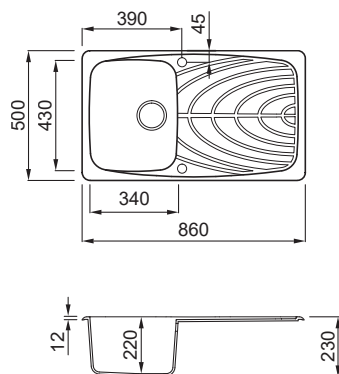

Lavello 1 vasca con gocciolatoio



CARATTERISTICHE

Dimensioni (mm)	860 x 500
Base (mm)	450
Foro da incasso (mm)	840 x 480
Profondità Vasca (mm)	220
Installazione	Sopratop
Orientamento	Reversibile

ACCESSORI CONSIGLIATI

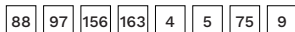

MATERIALI E COLORI

MATT	Nero G40	Euro 371 LGM40040
	Bianco G68	LGM40068
	Euro 371	
CLASSIC	Avena G51	LGM40051
	Antracite G59	LGM40059
	Bianco Antico G62	LGM40062

MASTER 300



Nero
G40

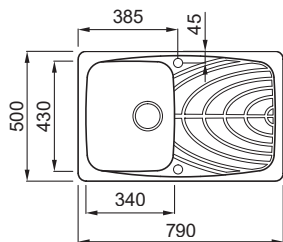

Lavello 1 vasca con gocciolatoio



CARATTERISTICHE

Dimensioni (mm)	790 x 500
Base (mm)	450
Foro da incasso (mm)	770 x 480
Profondità Vasca (mm)	220
Installazione	Sopratop
Orientamento	Reversibile

ACCESSORI CONSIGLIATI

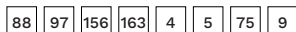

MATERIALI E COLORI

GRANITEK
NATURAL GRANITE EFFECT

MATT



Euro **371**
LGM30040
LGM30068

CLASSIC



Euro **371**
LGM30051
LGM30059
LGM30062

MASTER 450



Nero
G40

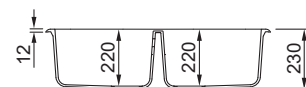
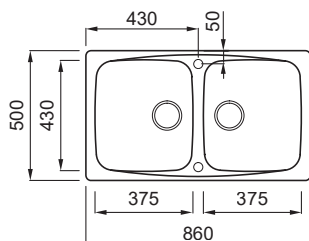

Lavello 2 vasche



CARATTERISTICHE

Dimensioni (mm)	860 x 500
Base (mm)	900
Foro da incasso (mm)	840 x 480
Profondità Vasca 1 (mm)	220
Profondità Vasca 2 (mm)	220
Installazione	Sopratop
Orientamento	Reversibile

ACCESSORI CONSIGLIATI

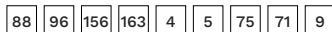

MATERIALI E COLORI

GRANITEK
NATURAL GRANITE EFFECT

MATT



Euro **394**
LGM45040
LGM45068

CLASSIC



Euro **394**
LGM45051
LGM45059
LGM45062

MASTER 350



Avena
G51

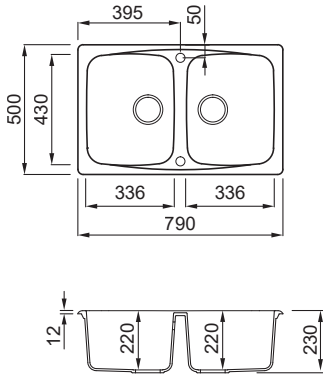

Lavello 2 vasche

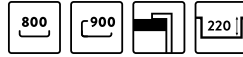

CARATTERISTICHE

Dimensioni (mm)	790 x 500
Base (mm)	800 900 se inizio composizione
Foro da incasso (mm)	770 x 480
Profondità Vasca 1 (mm)	220
Profondità Vasca 2 (mm)	220
Installazione	Sopratop
Orientamento	Reversibile

ACCESSORI CONSIGLIATI

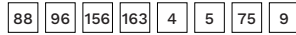

MATERIALI E COLORI

GRANITEK
NATURAL GRANITE EFFECT

MATT



Euro **394**

LGM35040

LGM35068

CLASSIC

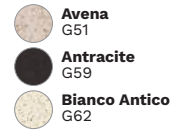

Euro **394**

LGM35051

LGM35059

LGM35062



Lavello Master 500 Avena G51 | Miscelatore Danubio Avena G51

COLLEZIONE
**LAVELLI
INOX**

**2 ANNI - YEARS
WARRANTY
GARANTITO**

CONFIGURA IL TUO LAVELLO INOX

Scegli tra collezione, tipologie e accessori per configurare il tuo lavello da cucina ideale.

SATINATA

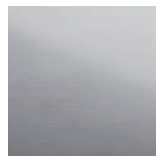

Opaco ma lucente, l'acciaio satinato conserva per anni, inalterati, i suoi valori di eleganza, igiene e resistenza all'usura dell'utilizzo quotidiano.



DISEGNI TECNICI
APPROFONDITI
GAMMA INOX

COLLEZIONE

COMPASS NEW

La linea Compass si caratterizza per il Banco Rubinetteria integrato e per le sue linee minimal. Vasche singole in diverse dimensioni, versatili e pratiche, apportano funzionalità in cucina. Collezione Compass in acciaio inox AISI 304 18/10.



FLAT



FILOTOP



PROFONDITÀ
VASCA
200 MM



MUNITO DI FORO
MISCELATORE

COLLEZIONE

ESPRIT NEW

Una serie di eleganti e funzionali vasche dal raggio interno minimo (12 mm), installabile in 3 modalità.

Semifilo: in appoggio sul piano di lavoro.

Filotop: con inserimento in un alloggiamento profondo 1 mm ricavato sul top.

Sottotop: sotto il piano di lavoro.

Collezione Esprit in acciaio inox AISI 304 18/10.



FLAT



FILOTOP



SOTTOTOP



PROFONDITÀ
VASCA
200 MM

COLLEZIONE

W-SQUARE

Vasche profonde ed alti spessori. Lavelli con raggio interno minimo (12 mm) e piletta quadrata dall'estetica ancora più accattivante.

Collezione W-Square con piletta quadrata, semifilo, filotop e sottotop in acciaio inox AISI 304 18/10.



FLAT



FILOTOP



SOTTOTOP



PROFONDITÀ
VASCA
200 MM



PILETTA
QUADRATA

COLLEZIONE

SKY

Per tutto il pianeta cucine. Design puro e semplice che trova posto in tutti i tipi di arredamento.

Collezione Sky da incasso in acciaio inox AISI 304 18/10.



SOPRATOP



PROFONDITÀ
VASCA
205 - 160 MM



MUNITO DI FORO
MISCELATORE

COMPASS 700 **NEW**



Satinato
ST

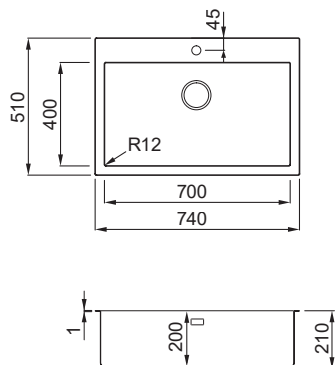

Lavello 1 vasca in acciaio inox satinato AISI 304 spessore 10/10



CARATTERISTICHE

Dimensioni (mm)	740 x 510
Raggio vasca (mm)	12
Base (mm)	800
Foro da incasso (mm)	730 x 495 R10 (Flat), 730 x 495 (Filotop)
Profondità Vasca (mm)	200
Installazione	Flat, Filotop
Orientamento	Non reversibile

Banco rubinetteria a bordo

ACCESSORI CONSIGLIATI

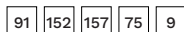

Corredo del lavello: Sifone salvaspazio, pilette, troppopieno e ganci fissaggio.

MATERIALI E COLORI

INOX



Euro **616**
LIM700SAC

COMPASS 500 **NEW**



Satinato
ST

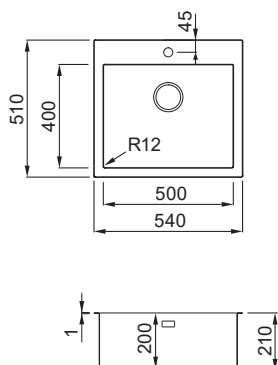

Lavello 1 vasca in acciaio inox satinato AISI 304 spessore 10/10



CARATTERISTICHE

Dimensioni (mm)	540 x 510
Raggio vasca (mm)	12
Base (mm)	600
Foro da incasso (mm)	530 x 495 R10 (Flat), 530 x 495 (Filotop)
Profondità Vasca (mm)	200
Installazione	Flat, Filotop
Orientamento	Non reversibile

Banco rubinetteria a bordo

ACCESSORI CONSIGLIATI

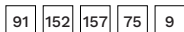

Corredo del lavello: Sifone salvaspazio, pilette, troppopieno e ganci fissaggio.

MATERIALI E COLORI

INOX



Euro **578**
LIM500SAC

COMPASS 400 NEW



Satinato
ST

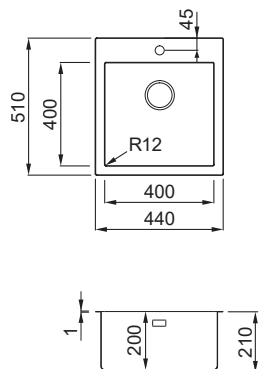

Lavello 1 vasca in acciaio inox satinato AISI 304 spessore 10/10



CARATTERISTICHE

Dimensioni (mm)	440 x 510
Raggio vasca (mm)	12
Base (mm)	450 (Flat), 600 (Filotop)
Foro da incasso (mm)	430 x 495 R10 (Flat), 430 x 495 (Filotop)
Profondità Vasca (mm)	200
Installazione	Flat, Filotop
Orientamento	Non reversibile

Banco rubinetteria a bordo

ACCESSORI CONSIGLIATI

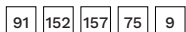

Corredo del lavello: Sifone salvaspazio, pilette, troppopieno e ganci fissaggio.

ACCESSORI LAVELLI INOX

COMPASS

91
**ELEMENT
TAGLIERE 420**
ATH040OL
Euro **128**
Pag. **143**



152
**ELEMENT
COLANDER 418**
AVP035BK
Euro **67**
Pag. **145**



157
**ELEMENT DRAINER
FLEX 440**
ARS013BK
Euro **83**
Pag. **144**



75
CESTELLO
ACI01307
Euro **105**
Pag. **151**



SKY (Escluso Sky Round 435)
88
**ELEMENT TAGLIERE
SLIDING 50 CM**
ATH010BK
Euro **153**
Pag. **142**



156
**ELEMENT DRAINER
FLEX 500**
ARS023BK
Euro **92**
Pag. **144**



ESPRIT **700** **NEW**



Satinato
ST

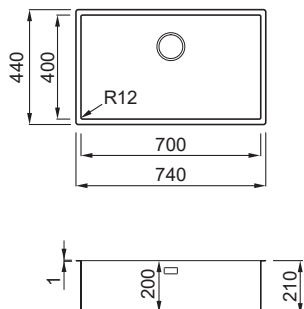

Lavello 1 vasca in acciaio inox satinato AISI 304 spessore 10/10



CARATTERISTICHE

Dimensioni (mm)	740 x 440
Raggio vasca (mm)	12
Base (mm)	800
Foro da incasso (mm)	730 x 430 R10 (Flat), 701 x 401 R13 (Sottotop), 730 x 430 (Filotop)
Profondità Vasca (mm)	200
Installazione	Flat, Filotop, Sottotop
Orientamento	Non reversibile

ACCESSORI CONSIGLIATI

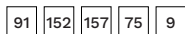

Corredo del lavello: Sifone salvaspazio, pilette, troppopieno e ganci fissaggio.

MATERIALI E COLORI

INOX



Euro **508**
LIE700SAC

ESPRIT **500** **NEW**



Satinato
ST

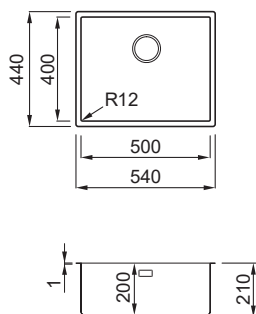

Lavello 1 vasca in acciaio inox satinato AISI 304 spessore 10/10



CARATTERISTICHE

Dimensioni (mm)	540 x 440
Raggio vasca (mm)	12
Base (mm)	600
Foro da incasso (mm)	530 x 430 R10 (Flat), 501 x 401 R13 (Sottotop), 530 x 430 (Filotop)
Profondità Vasca (mm)	200
Installazione	Flat, Filotop, Sottotop
Orientamento	Non reversibile

ACCESSORI CONSIGLIATI

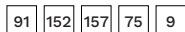

Corredo del lavello: Sifone salvaspazio, pilette, troppopieno e ganci fissaggio.

MATERIALI E COLORI

INOX



Euro **448**
LIE500SAC

ESPRIT 400 NEW



Satinato
ST

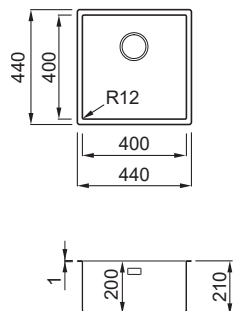

Lavello 1 vasca in acciaio inox satinato AISI 304 spessore 10/10



CARATTERISTICHE

Dimensioni (mm)	440 x 440
Raggio vasca (mm)	12
Base (mm)	450 (Flat, Sottotop), 600 (Filotop)
Foro da incasso (mm)	430 x 430 R10 (Flat), 401 x 401 R13 (Sottotop), 430 x 430 (Filotop)
Profondità Vasca (mm)	200
Installazione	Flat, Filotop, Sottotop
Orientamento	Non reversibile

ACCESSORI CONSIGLIATI

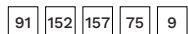

Corredo del lavello: Sifone salvaspazio, pilette, troppopieno e ganci fissaggio.

ACCESSORI LAVELLI INOX

ESPRIT

91
**ELEMENT
TAGLIERE 420**
ATH040OL
Euro **128**
Pag. **143**



152
**ELEMENT
COLANDER 418**
AVP035BK
Euro **67**
Pag. **145**



157
**ELEMENT DRAINER
FLEX 440**
ARS013BK
Euro **83**
Pag. **144**



75
CESTELLO
ACI01307
Euro **105**
Pag. **151**



SKY (Escluso Sky Round 435)

88
**ELEMENT TAGLIERE
SLIDING 50 CM**
ATH010QU
Euro **153**
Pag. **142**



156
**ELEMENT DRAINER
FLEX 500**
ARS023BK
Euro **92**
Pag. **144**



W-SQUARE 700



Satinato
ST

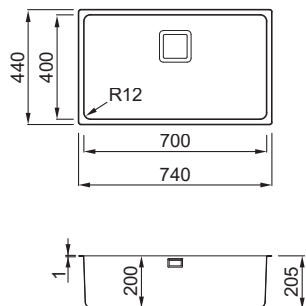

Lavello 1 vasca in acciaio inox satinato AISI 304 spessore 10/10



CARATTERISTICHE

Dimensioni (mm)	740 x 440
Raggio vasca (mm)	12
Base (mm)	800
Foro da incasso (mm)	730 x 430 R10 (Flat), 701 x 401 R13 (Sottotop), 730 x 430 (Filotop)
Profondità Vasca (mm)	200
Installazione	Flat, Filotop, Sottotop
Orientamento	Non reversibile

ACCESSORI CONSIGLIATI

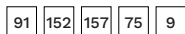

Corredo del lavello: Sifone salvaspazio, pilette, troppopieno e ganci fissaggio.

W-SQUARE 500



Satinato
ST

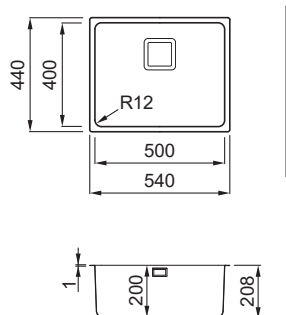

Lavello 1 vasca in acciaio inox satinato AISI 304 spessore 10/10



CARATTERISTICHE

Dimensioni (mm)	540 x 440
Raggio vasca (mm)	12
Base (mm)	600
Foro da incasso (mm)	530 x 430 R10 (Flat), 501 x 401 R13 (Sottotop), 530 x 430 (Filotop)
Profondità Vasca (mm)	200
Installazione	Flat, Filotop, Sottotop
Orientamento	Non reversibile

ACCESSORI CONSIGLIATI

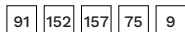

Corredo del lavello: Sifone salvaspazio, pilette, troppopieno e ganci fissaggio.

MATERIALI E COLORI

INOX

Euro **506**



LIW700SACMU

MATERIALI E COLORI

INOX

Euro **418**



LIW500SACMU

W-SQUARE 400



Satinato
ST

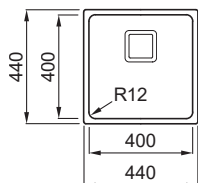

Lavello 1 vasca in acciaio inox satinato AISI 304 spessore 10/10



CARATTERISTICHE

Dimensioni (mm)	440 x 440
Raggio vasca (mm)	12
Base (mm)	450 (Flat, Sottotop), 600 (Filotop)
Foro da incasso (mm)	430 x 430 R10 (Flat), 401 x 401 R13 (Sottotop), 430 x 430 (Filotop)
Profondità Vasca (mm)	200
Installazione	Flat, Filotop, Sottotop
Orientamento	Non reversibile

ACCESSORI CONSIGLIATI

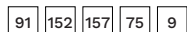

Corredo del lavello: Sifone salvaspazio, pilette, troppopieno e ganci fissaggio.

ACCESSORI LAVELLI INOX

W-SQUARE

91

ELEMENT TAGLIERE 420

ATH040OL
Euro **128**

Pag. **143**



152

ELEMENT COLANDER 418

AVP035BK
Euro **67**

Pag. **145**



157

ELEMENT DRAINER FLEX 440

ARS013BK
Euro **83**

Pag. **144**



75

CESTELLO

ACI01307
Euro **105**

Pag. **151**



SKY (Escluso Sky Round 435)

88

ELEMENT TAGLIERE SLIDING 50 CM

ATH010QU
Euro **153**

Pag. **142**



156

ELEMENT DRAINER FLEX 500

ARS023BK
Euro **92**

Pag. **144**



SKY 500



Satinato
ST

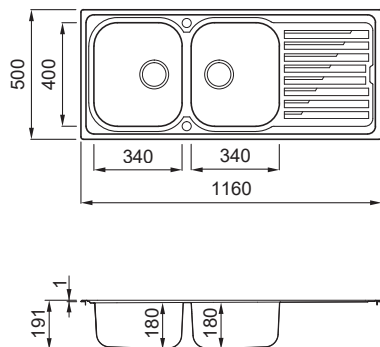

Lavello in acciaio inox satinato AISI 304 spessore 6/10 2 vasche con gocciolatoio



CARATTERISTICHE

Dimensioni (mm)	1160 x 500
Base (mm)	800
Foro da incasso (mm)	1140 x 480
Profondità Vasca 1 (mm)	180
Profondità Vasca 2 (mm)	180
Installazione	Sopratop
Orientamento	Non reversibile

Banco rubinetteria a bordo

ACCESSORI CONSIGLIATI



Corredo del lavello: Sifone salvaspazio, pilette, troppopieno e ganci fissaggio.

SKY 480



Satinato
ST

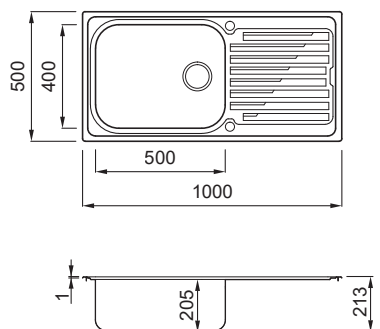

Lavello in acciaio inox satinato AISI 304 spessore 6/10 1 vasca con gocciolatoio



CARATTERISTICHE

Dimensioni (mm)	1000 x 500
Base (mm)	600
Foro da incasso (mm)	980 x 480
Profondità Vasca (mm)	205
Installazione	Sopratop
Orientamento	Non reversibile

Banco rubinetteria a bordo

ACCESSORI CONSIGLIATI



Corredo del lavello: Sifone salvaspazio, pilette, troppopieno e ganci fissaggio.

MATERIALI E COLORI

INOX



Euro **312**
LIK500SACDX
LIK500SACSX

MATERIALI E COLORI

INOX



Euro **304**
LIK480SACDX
LIK480SACSX

SKY 400



Satinato
ST

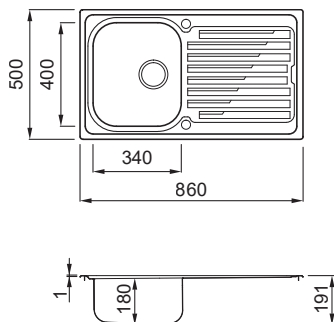

Lavello in acciaio inox satinato AISI 304
spessore 6/10 1 vasca con gocciolatoio



CARATTERISTICHE

Dimensioni (mm)	860 x 500
Base (mm)	450
Foro da incasso (mm)	840 x 480
Profondità Vasca (mm)	180
Installazione	Sopratop
Orientamento	Non reversibile

Banco rubinetteria a bordo

ACCESSORI CONSIGLIATI



Corredo del lavello: Sifone salvaspazio, pilette, troppopieno e ganci fissaggio.

SKY 125



Satinato
ST

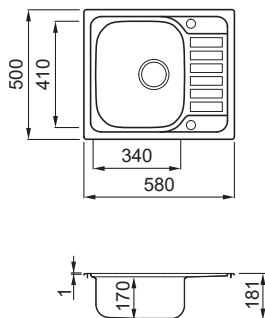

Lavello in acciaio inox satinato AISI 304
spessore 6/10 1 vasca con gocciolatoio



CARATTERISTICHE

Dimensioni (mm)	580 x 500
Base (mm)	450
Foro da incasso (mm)	560 x 480
Profondità Vasca (mm)	170
Installazione	Sopratop
Orientamento	Non reversibile

Banco rubinetteria a bordo

ACCESSORI CONSIGLIATI

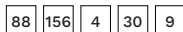

Corredo del lavello: Sifone salvaspazio, pilette, troppopieno e ganci fissaggio.

MATERIALI E COLORI

INOX



Euro **232**
LIK400SACDX
LIK400SACSX

MATERIALI E COLORI

INOX



Euro **126**
LIX125SACDX
LIX125SACSX

SKY 360



Satinato
ST

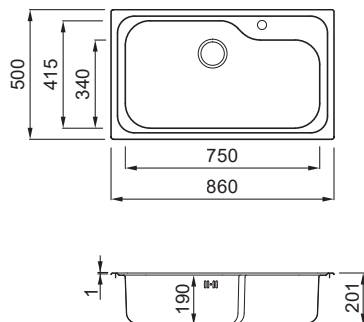

Lavello 1 vasca in acciaio inox satinato AISI 304 spessore 6/10



CARATTERISTICHE

Dimensioni (mm)	860 x 500
Base (mm)	900
Foro da incasso (mm)	840 x 480
Profondità Vasca (mm)	190
Installazione	Sopratop
Orientamento	Non reversibile

Banco rubinetteria a bordo

ACCESSORI CONSIGLIATI

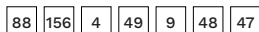

Corredo del lavello: Sifone salvaspazio, pilette, troppopieno e ganci fissaggio.

SKY 450



Satinato
ST

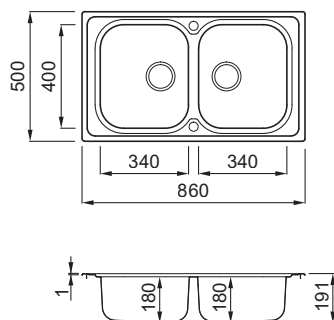

Lavello 2 vasche in acciaio inox satinato AISI 304 spessore 6/10



CARATTERISTICHE

Dimensioni (mm)	860 x 500
Base (mm)	800 900 se inizio composizione
Foro da incasso (mm)	840 x 480
Profondità Vasca 1 (mm)	180
Profondità Vasca 2 (mm)	180
Installazione	Sopratop
Orientamento	Reversibile

Banco rubinetteria a bordo

ACCESSORI CONSIGLIATI



Corredo del lavello: Sifone salvaspazio, pilette, troppopieno e ganci fissaggio.

MATERIALI E COLORI

INOX



Euro **377**
LIK360SAC

MATERIALI E COLORI

INOX



Euro **282**
LIK450SAC

SKY 435 ROUND



Satinato
ST

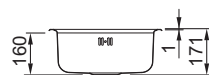
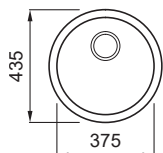

Lavello 1 vasca in acciaio inox satinato AISI 304 spessore 6/10



CARATTERISTICHE

Dimensioni (mm)	Ø 435
Base (mm)	450
Foro da incasso (mm)	Ø 415
Profondità Vasca (mm)	160
Installazione	Sopratop
Orientamento	Non reversibile

ACCESSORI CONSIGLIATI

15

Corredo del lavello: Sifone salvaspazio, pilette, troppopieno e ganci fissaggio.

MATERIALI E COLORI

INOX



Euro **117**
LIKROUSAC

SKY CORNER



Satinato
ST

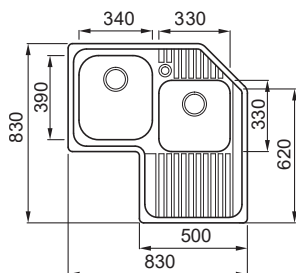

Lavello angolare in acciaio inox satinato AISI 304 spessore 6/10 2 vasche con gocciolatoio



CARATTERISTICHE

Dimensioni (mm)	830 x 830
Base (mm)	Corner
Foro da incasso (mm)	Da dima*
Profondità Vasca 1 (mm)	210
Profondità Vasca 2 (mm)	200
Installazione	Sopratop
Orientamento	Non reversibile

ACCESSORI CONSIGLIATI

88 156 4 30 9

Corredo del lavello: Sifone salvaspazio, pilette, troppopieno e ganci fissaggio.

*dima inclusa nella confezione o scaricabile dalla sezione download specifica del sito www.elleci.com/it

MATERIALI E COLORI

INOX



Euro **782**
LIKORSACDX



LIKORSACSX

ACCESSORI LAVELLI INOX

SKY

91
**ELEMENT
 TAGLIERE 420**
 ATH040OL
 Euro **128**
 Pag. **143**



152
**ELEMENT
 COLANDER 418**
 AVP035BK
 Euro **67**
 Pag. **145**



157
**ELEMENT DRAINER
 FLEX 440**
 ARS013BK
 Euro **83**
 Pag. **144**



75
CESTELLO
 ACI01307
 Euro **105**
 Pag. **151**



SKY (Escluso Sky Round 435)

88
**ELEMENT TAGLIERE
 SLIDING 50 CM**
 ATH010QU
 Euro **153**
 Pag. **142**



156
**ELEMENT DRAINER
 FLEX 500**
 ARS023BK
 Euro **92**
 Pag. **144**



LAVELLI INOX



Compass 700 | Miscelatore Flux Cromato | Element Drainer flex 500 | Piano induzione Urban 80

COLLEZIONE
ACCESSORI



THE IDEAL PARTNER FOR EVERY MOMENT

Accessori Elleci: i perfetti alleati in cucina; ottimizzano lo spazio nell'area preparazione con soluzioni tecniche e funzionali che possono caratterizzare e rendere unico lo stile della cucina.

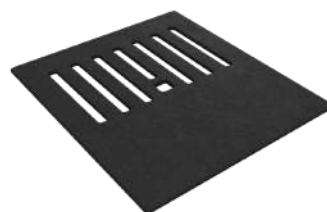

TAGLIERE ELEMENT BEST WORKSTATION

Uno speciale tagliere che grazie al suo design diviene sistema multifunzione salvaspazio in quanto utilizzabile sia a bordo lavello che all'interno della vasca.

- BLACK
- GREY
- WOOD
- QUERCIA
- OLMO



COLANDER ELEMENT BEST WORKSTATION

L'accessorio ideale per organizzare e scolare.



- BLACK
- CR CROMATO

**ELEMENT DISPENSER
SAPONE TONDO**

Un utile accessorio integrato che crea spazio aggiuntivo nel lavello.



DRAINER FLEX 500

Dall'utilizzo versatile è comodissimo sia come scolapiatti (posizionato sopra il lavello) che come tappetino appoggiato sul top cucina.



- BLACK
- INOX
- GOLD

**KIT ELEMENT
OPEN UP FLOW PRO**

Il suo stile semplice ma elegante e la semplicità di utilizzo lo rendono un kit moderno e adeguato per ogni stile.

193 ELEMENT TAGLIERE SPAZIO

Tagliere multifunzione in HPL

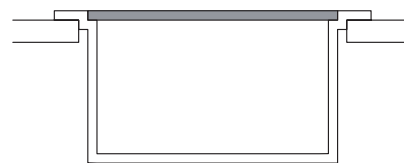
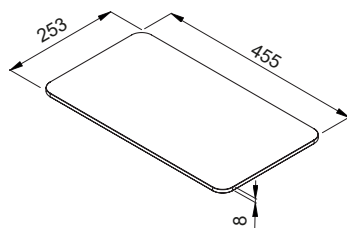

COLORI DISPONIBILI

- Black**
ATH123BK Euro **112**
- Wood**
ATH123WD Euro **112**

COMPATIBILITÀ COLLEZIONE

SPAZIO



88 ELEMENT TAGLIERE SLIDING 50

Tagliere multifunzione in HPL

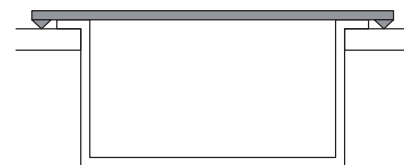
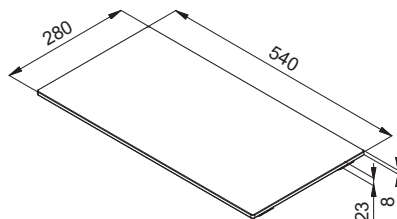

COLORI DISPONIBILI

- Black**
ATH010BK Euro **153**
- Grey**
ATH010GR Euro **153**
- Quercia**
ATH010QU Euro **153**
- Olmo**
ATH010OL Euro **153**

COMPATIBILITÀ COLLEZIONE

UNICO
MASTER
KARISMA
FOX
EGO
EASY
SKY



89 ELEMENT TAGLIERE BEST LINE

Tagliere multifunzione in HPL

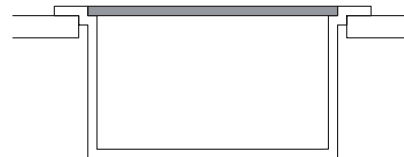
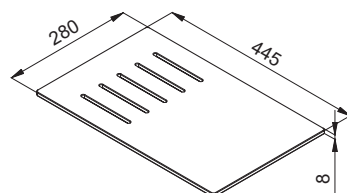

COLORI DISPONIBILI

- Black**
ATH020BK Euro **128**
- Grey**
ATH020GR Euro **128**
- Quercia**
ATH020QU Euro **128**
- Olmo**
ATH020OL Euro **128**

COMPATIBILITÀ COLLEZIONE

BEST



91 **ELEMENT TAGLIERE 420**

Tagliere multifunzione in HPL

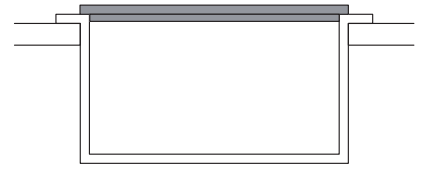
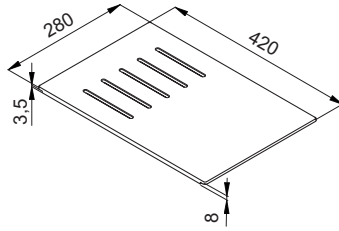

COLORI DISPONIBILI

● Black	ATH040BK	Euro 128
● Grey	ATH040GR	Euro 128
● Quercia	ATH040QU	Euro 128
● Olmo	ATH040OL	Euro 128
● Wood	ATH040WD	Euro 128

COMPATIBILITÀ COLLEZIONE

ZEN
QUADRA
INTEGRA
W-SQUARE
COMPASS
ESPRIT
ZEN-F



155 **ELEMENT TAGLIERE FOX 360**

Tagliere multifunzione in HPL con vaschetta

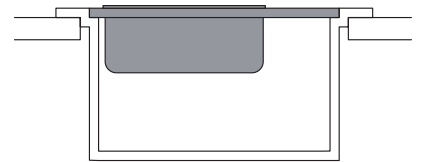
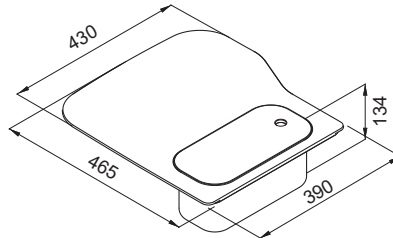

COLORI DISPONIBILI

● Quercia	ATH130QU	Euro 187
● Olmo	ATH130OL	Euro 187

COMPATIBILITÀ COLLEZIONE

FOX



93 **ELEMENT TAGLIERE BEST WORKSTATION**

Tagliere multifunzione in HPL

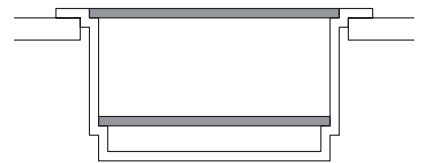
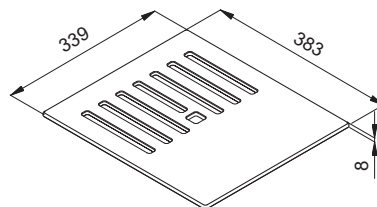

COLORI DISPONIBILI

● Black	ATH073BK	Euro 132
● Grey	ATH073GR	Euro 132
● Quercia	ATH073QU	Euro 132
● Olmo	ATH073OL	Euro 132
● Wood	ATH073WD	Euro 132

COMPATIBILITÀ COLLEZIONE

BEST WORKSTATION



157 ELEMENT DRAINER FLEX 440

Drainer Flex in silicone

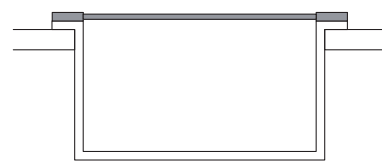
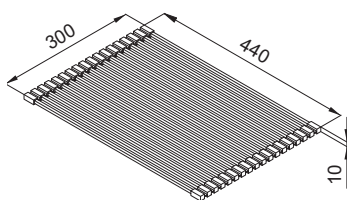

COLORI DISPONIBILI

● **Black**
ARS013BK Euro **83**

COMPATIBILITÀ COLLEZIONE

GLOBE
ZEN
QUADRA
QUADRA SOTTOTOP
KARISMA
INTEGRA
EASY
W-SQUARE
COMPASS
ESPRIT
ZEN-F



156 ELEMENT DRAINER FLEX 500

Drainer Flex in silicone

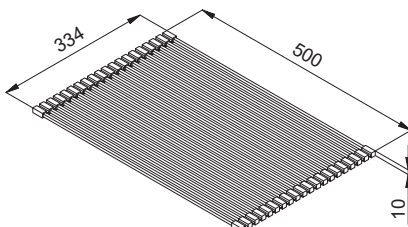

COLORI DISPONIBILI

● **Black**
ARS023BK Euro **92**

COMPATIBILITÀ COLLEZIONE

UNICO
QUADRA
QUADRA SOTTOTOP
MASTER
FOX
EGO
EASY
BEST
BEST WORKSTATION
SKY

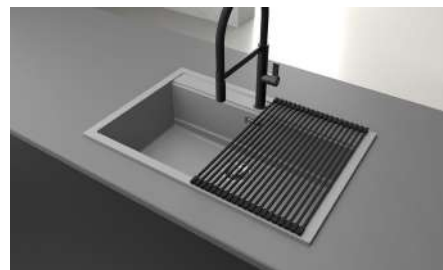

153 ELEMENT COLANDER BEST WORKSTATION

Colander in Polipropilene

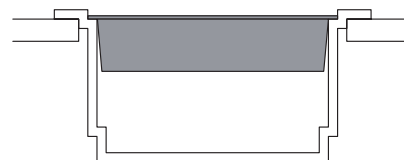
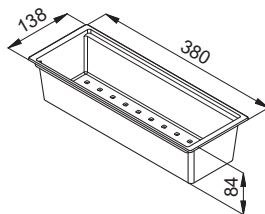

COLORI DISPONIBILI

● **Black**
AVP034BK Euro **67**

COMPATIBILITÀ COLLEZIONE

BEST WORKSTATION



152 **ELEMENT COLANDER** 418

Colander in Polipropilene

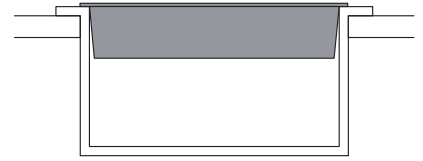
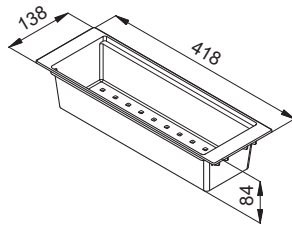

COLORI DISPONIBILI

● **Black**
AVP035BK Euro **67**

COMPATIBILITÀ COLLEZIONE

ZEN
QUADRA
QUADRA SOTTOTOP
INTEGRA
SKY
W-SQUARE
COMPASS
ESPRIT
ZEN-F



25 **ELEMENT DISPENSER SAPONE TONDO**

Dispenser sapone

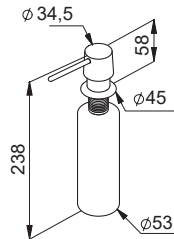

COLORI DISPONIBILI

● **Cromato**
ADI02300 Euro **44**
● **Black**
ADI02300BK Euro **67**

COMPATIBILITÀ COLLEZIONE

UNICO
QUADRA
QUADRA SOTTOTOP
FOX
EASY
BEST WORKSTATION



50 **ELEMENT DISPENSER SAPONE QUADRATO**

Dispenser sapone

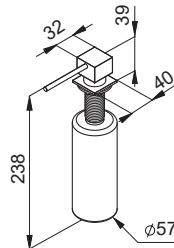

COLORI DISPONIBILI

● **Cromato**
ADI02301 Euro **106**

COMPATIBILITÀ COLLEZIONE

UNICO
QUADRA
QUADRA SOTTOTOP
KARISMA
EASY
BEST WORKSTATION



163 ELEMENT COVER PILETTA MATERICA

Cover piletta materica

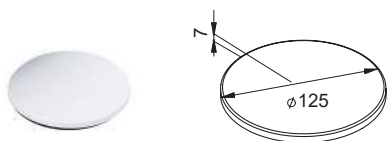











COMPATIBILITÀ COLLEZIONE

ZEN
UNICO
QUADRA
QUADRA SOTTOTOP
MASTER
INTEGRA
FOX
EGO
EASY
BEST
BEST WORKSTATION



COLORI DISPONIBILI

 Black AKCP1286 Euro 44	 Dark Grey AKCP1299 Euro 44
 Dove Grey AKCP1293 Euro 44	 Nero AGCP1240 Euro 44
 Champagne AKCP1295 Euro 44	 Tortora AGCP1243 Euro 44
 White AKCP1296 Euro 44	 Cemento AGCP1248 Euro 44
 Light Grey AKCP1297 Euro 44	 Bianco AGCP1268 Euro 44



88 KIT PILETTA E TROPPOPIENO

Kit Piletta e Troppopieno

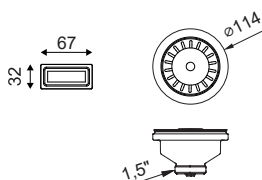

COLORI DISPONIBILI

 Black COMPP90CTPLUXABK Euro 77

COMPATIBILITÀ COLLEZIONE

ZEN
INTEGRA
BEST
BEST WORKSTATION



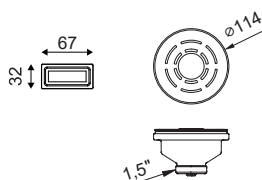

164 ELEMENT KIT FLOW PRO E TROPPO PIENO

Kit Piletta Flow Pro e Troppopieno



COLORI DISPONIBILI

 Black Matt KITWPT-F-1VSELL-BK Euro 115
 Gold KITWPT-F-1VSELL-GD Euro 95

COMPATIBILITÀ COLLEZIONE

SPAZIO
BEST WORKSTATION
ZEN
ZEN F
INTEGRA
BEST



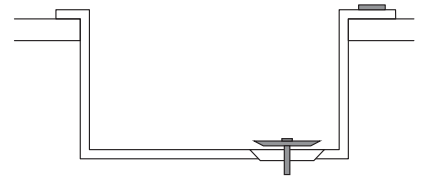
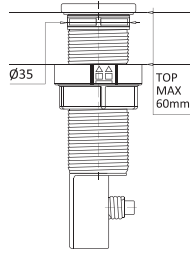

100 **ELEMENT OPEN-UP** PUSH CONTROL

Sistema di scarico 1 via via Flow Pro con comando remoto Open Up



COLORI DISPONIBILI

-  **Inox**
ASP13004 Euro **66**
-  **Gold**
ASP13004GD Euro **146**
-  **Black**
ASP13004BK Euro **146**

COMPATIBILITÀ COLLEZIONE

SPAZIO
BEST WORKSTATION
ZEN
ZEN F
INTEGRA
BEST



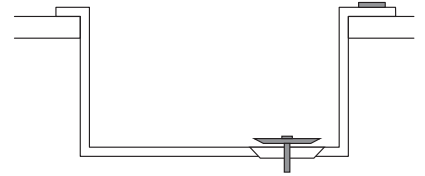
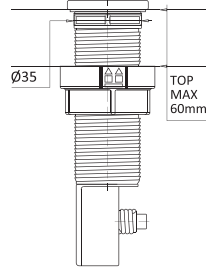

97 **ELEMENT POP-UP** PUSH CONTROL

Kit piletta automatica a 1 via



COLORI DISPONIBILI

-  **Cromato**
ASP13002 Euro **38**
-  **Black**
ASP13002BK Euro **100**

COMPATIBILITÀ COLLEZIONE

UNICO
QUADRA
MASTER
FOX
EGO
EASY
BEST
BEST WORKSTATION



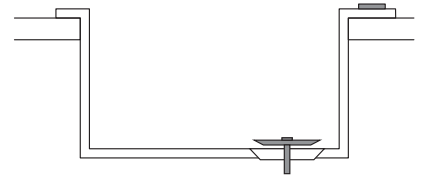
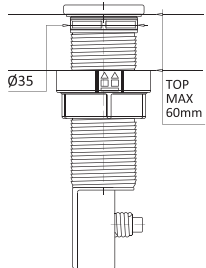

96 **ELEMENT POP-UP** PUSH CONTROL 2 VIE

Kit piletta automatica a 2 vie



COLORI DISPONIBILI

-  **Cromato**
ASP23002 Euro **74**
-  **Black**
ASP23002BK Euro **135**

COMPATIBILITÀ COLLEZIONE

UNICO
QUADRA
QUADRA SOTTOTOP
MASTER
FOX
EGO
EASY
BEST



97 ELEMENT POP-UP PUSH CONTROL

Kit piletta quadrata automatica a 1 via

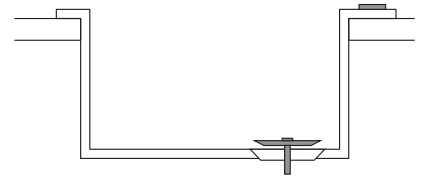
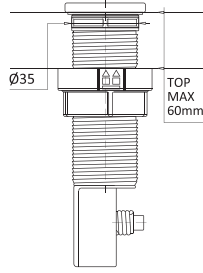

COLORI DISPONIBILI

● Cromato
ASP16302

Euro 62

COMPATIBILITÀ COLLEZIONE

KARISMA





ACCESSORI

TAGLIERI

4 TAGLIERE SCORREVOLE IN LEGNO



CARATTERISTICHE
 Dimensione (mm) 540 x 300
 Codice ATL01000
 Euro 104

10 TAGLIERE IN LEGNO EGO ROUND



CARATTERISTICHE
 Dimensione (mm) Ø435
 Codice ATL02300
 Euro 98

16 TAGLIERE IN LEGNO FOX ROUND / SKY ROUND 435



CARATTERISTICHE
 Dimensione (mm) Ø395
 Codice ATL02301
 Euro 98

46 TAGLIERE SKY 360



CARATTERISTICHE
 Dimensione (mm) 375 x 435
 Codice ATL01303
 Euro 90

COLANDER

5 COLANDER



CARATTERISTICHE
 Dimensione (mm) 322 x 195 x 95
 Codice AVI03001
 Euro 131

63 COLANDER EASY CORNER



CARATTERISTICHE
 Dimensione (mm) 400 x 284 x 8
 Codice AVI03307
 Euro 121

61 COLANDER STD L



CARATTERISTICHE
 Dimensione (mm) 462 x 134 x 72
 Codice AVI03305
 Euro 131

70 COLANDER BEST LINE



CARATTERISTICHE
 Dimensione (mm) 444 x 142 x 103
 Codice AVI03000
 Euro 114

BOTTOM GRID

43 BOTTOM GRID



CARATTERISTICHE
 Dimensione (mm) 277 x 348
 Codice AGB01300
 Euro 78

67 BOTTOM GRID M

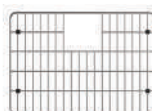

CARATTERISTICHE
 Dimensione (mm) 445 x 310
 Codice AGB01304
 Euro 110

68 BOTTOM GRID L



CARATTERISTICHE
 Dimensione (mm) 590 x 334
 Codice AGB01303
 Euro 110

71 BOTTOM GRID S



CARATTERISTICHE
 Dimensione (mm) 285 x 300
 Codice AGB01306
 Euro 120

CESTELLI

8 CESTELLO EGO ROUND



CARATTERISTICHE

Dimensione (mm) Ø 345
Codice ACI02300
Euro 54

11 CESTELLO FOX 360



CARATTERISTICHE

Dimensione (mm) 405 x 312 x 195
Codice ACI03300
Euro 108

15 CESTELLO FOX ROUND / EASY ROUND / SKY ROUND 435



CARATTERISTICHE

Dimensione (mm) Ø 320
Codice ACI02301
Euro 74

69 CESTELLO BEST LINE



CARATTERISTICHE

Dimensione (mm) 444 x 292 x 82
Codice ACI01306
Euro 93

30 CESTELLO SKY



CARATTERISTICHE

Dimensione (mm) 348 x 324 x 112
Codice ACI01304
Euro 96

75 CESTELLO



CARATTERISTICHE

Dimensione (mm) 385 x 270 x 180
Codice ACI01307
Euro 105

49 CESTELLO SKY 360



CARATTERISTICHE

Dimensione (mm) 375 x 250 x 190
Codice ACI01305
Euro 130

ALTRI ACCESSORI

9 SCOLAPIATTI



CARATTERISTICHE

Dimensione (mm) 300 x 185 x 82
Codice ADI01300
Euro 50

48 VASCHETTA IN POLICARBONATO SKY 360



CARATTERISTICHE

Dimensione (mm) 270 x 137 x 60
Codice AVP01302
Euro 23

47 VASCHETTA SKY 360



CARATTERISTICHE

Dimensione (mm) 274 x 148 x 63
Codice AVI03002
Euro 62

COLLEZIONE MISCELATORI

Pensati per caratterizzare gli ambienti e per soddisfare le esigenze di ogni tipo di cucina, uniscono estetica e funzionalità. Una linea di miscelatori di design in diverse finiture e stili; moderni, utili ed al tempo stesso rispettosi dell'ambiente.



FULL COLOR

Miscelatori verniciati in ogni parte e componente del colore del lavello per un abbinamento perfetto ed una sensazione di continuità totale.

METAL FINISHINGS

Finiture eleganti e raffinate. Una Family line studiata per il perfect match con le componenti del lavello e con il mondo della cottura Elleci.



BLACK MATT

Una speciale finitura che incarna uno dei principali trend del design e si adatta anche alla perfezione a quasi qualsiasi stile offrendo infinite possibilità di personalizzazione.

ENERGY SAVE CARTRIDGE

Tecnologia che consente di erogare solo acqua fredda con la leva in posizione centrale, risparmiando energia e rispettando l'ambiente.

PROFESSIONAL



NEW **ARCADIA** *
PAG. 154

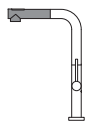

FLUX *
PAG. 155

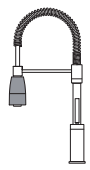

CHEF *
PAG. 156

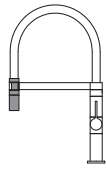

WAVE *
PAG. 154

CANNA L

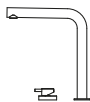

NEW **KENT**
PAG. 155

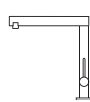

TEMA
PAG. 156

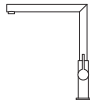

ARES
PAG. 157

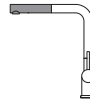

STREAM PLUS *
PAG. 158

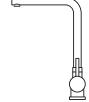

DANUBIO
PAG. 165

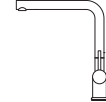

STREAM
PAG. 158



TRAIL PLUS *
PAG. 159

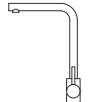

TRAIL
PAG. 159

FILTRANTE

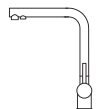

TOURMALINE
PAG. 160

CANNA A PONTE

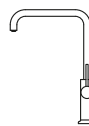

NEW **HYPE**
PAG. 162

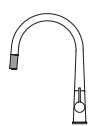

NEW **ATHENA PLUS** *
PAG. 161

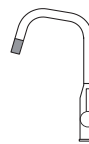

DORA PLUS *
PAG. 162

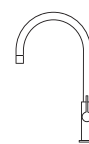

VOLTA
PAG. 164

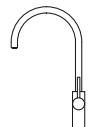

NEW **CLUB**
PAG. 163



NEVA *
PAG. 165

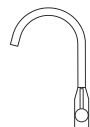

ADIGE
PAG. 162



ATHENA
PAG. 161



BRIDGE
PAG. 163



CLOUD
PAG. 164

TRADITIONAL

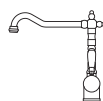

RIO
PAG. 169

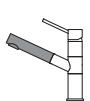

RENO *
PAG. 166

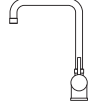

SENNA
PAG. 167

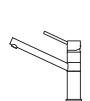

SAVA
PAG. 166

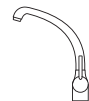

PO
PAG. 167



VENERE *
PAG. 168



MINERVA
PAG. 168

FUNZIONI
MISCELATORI



CANNA GIREVOLE

*



DOCCETTA



CAMBIO GETTO



FILTRANTE



SOTTO FINESTRA



FULL COLOR



SAVE ENERGY CARTRIDGE

MISCELATORI
ARCADIA **NEW**



Miscelatore monocomando con canna alta girevole e doccetta estraibile doppio getto

CARATTERISTICHE

Base (mm) **47**
Rotazione canna **360°**
Tipologia flessibile **Inox 3/8"**
Lunghezza flessibile **390 mm**
Cartuccia (ø mm) **25**
Foro top (mm) **35**

FINITURE Euro **390**

 **Cromato CR** MIKARCCR

COLORE * Euro **480**

 **Black BK** MOKARCBK

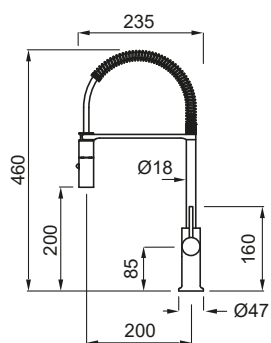

CR Cromato

WAVE



Miscelatore monocomando con canna alta girevole in silicone e doccetta estraibile

CARATTERISTICHE

Base (mm) **50**
Rotazione canna **360°**
Tipologia flessibile **Inox 3/8"**
Lunghezza flessibile **400 mm**
Cartuccia (ø mm) **25**
Foro top (mm) **35**

FINITURE Euro **315**

 **Cromato CR** MIKWAVCR

COLORE * Euro **357**

 **Black BK** MOKWAVBK

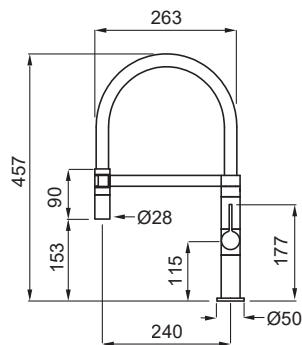

CR Cromato

* Colori abbinabili ai materiali Keratek e Granitek

KENT NEW



Miscelatore monocomando con canna girevole e comando remoto

CARATTERISTICHE

Base (mm) **46 (canna) - 52 (comando)**
 Rotazione canna **360°**
 Tipologia flessibile **Inox 3/8"**
 Lunghezza flessibile **490 mm**
 Cartuccia (ø mm) **25**
 Foro top (mm) **35 (canna) - 35 (comando)**

FINITURE Euro **520**

 **Cr. Spazzolato CS** MIKKENCS

Euro **650**

 **Gold GD** MOKKENG

COLORE * Euro **460**

 **Black BK** MOKKENBK

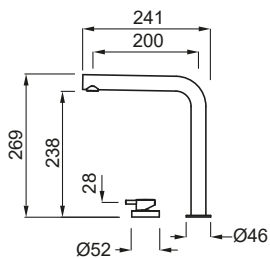

CS Cr. Spazzolato

FLUX



Miscelatore monocomando con canna girevole e doccetta estraibile doppio getto

CARATTERISTICHE

Base (mm) **50**
 Rotazione canna **360°**
 Tipologia flessibile **Inox 3/8"**
 Lunghezza flessibile **550 mm**
 Cartuccia (ø mm) **25**
 Foro top (mm) **35**

FINITURE Euro **428**

 **Cromato CR** MIKFLUCR

COLORE * Euro **473**

 **Black BK** MOKFLUBK

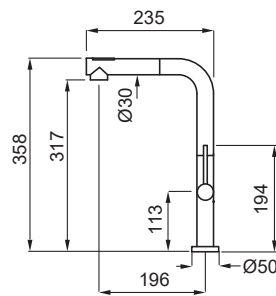

CR Cromato

* Colori abbinabili ai materiali Keratek e Granitek

MISCELATORI

MISCELATORI CHEF



Black
K86

Miscelatore monocomando con canna alta girevole e doccia a doppio getto

CARATTERISTICHE

Base (mm) **50**
 Rotazione canna **360°**
 Tipologia flessibile **Inox 3/8"**
 Lunghezza flessibile **350 mm**
 Cartuccia (ø mm) **35**
 Foro top (mm) **35**

FINITURE Euro 360

 **Cromato CR** MIKCHECR

COLORE * Euro 398

 **Black K86** MKKCHE86
 **Nero G40** MGKCHE40

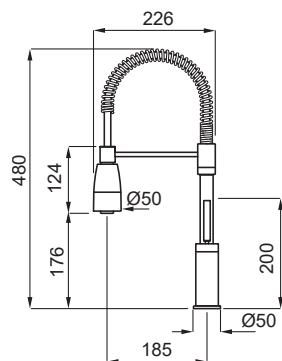

CR Cromato

TEMA



Light Grey
K97

Miscelatore monocomando con canna girevole





CARATTERISTICHE

Base (mm) **50**
 Rotazione canna **360°**
 Tipologia flessibile **Inox 3/8"**
 Lunghezza flessibile **700 mm**
 Cartuccia (ø mm) **25**
 Foro top (mm) **35**

FINITURE Euro 518

 **Cromato CR** MIKTEMCR

COLORE * Euro 574

 **Black K86** MKKTEM86
 **Dove Grey K93** MKKTEM93
 **Champagne K95** MKKTEM95
 **White K96** MKKTEM96
 **Light Grey K97** MKKTEM97
 **Dark Grey K99** MKKTEM99

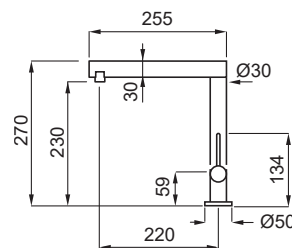

CR Cromato

* Colori abbinabili ai materiali Keratek e Granitek

HYPE NEW





Miscelatore monocomando con canna girevole

CARATTERISTICHE

Base (mm) **47**
 Rotazione canna **360°**
 Tipologia flessibile **Inox 3/8"**
 Lunghezza flessibile **390 mm**
 Cartuccia (ø mm) **25**
 Foro top (mm) **35**

FINITURE Euro **398**

 **Cr. Spazzolato** MIKHYP
 CS
 **Gold** MOKHYPGD
 GD

COLORE * Euro **318**

 **Black** MOKHYPBK
 BK

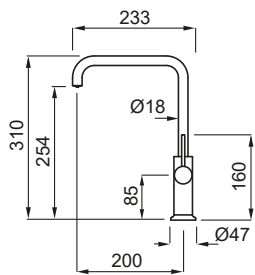

CS Cr. Spazzolato

ARES



Miscelatore monocomando con canna girevole









CARATTERISTICHE

Base (mm) **45**
 Rotazione canna **360°**
 Tipologia flessibile **Inox 3/8"**
 Lunghezza flessibile **350 mm**
 Cartuccia (ø mm) **25**
 Foro top (mm) **35**

FINITURE Euro **345**

 **Cromato** MIKARECR
 CR

COLORE * Euro **430**

 **Black** MKKARE86
 K86
 **White** MKKARE96
 K96
 **Titanium** MMKARE73
 M73
 **Aluminium** MMKARE79
 M79
 **Nero** MGKARE40
 G40
 **Tortora** MGKARE43
 G43
 **Cemento** MGKARE48
 G48
 **Bianco** MGKARE68
 G68

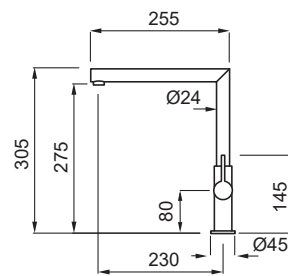

CR Cromato

* Colori abbinabili ai materiali Keratek e Granitek

MISCELATORI

MISCELATORI STREAM



Tortora
G43

Miscelatore monocomando con canna girevole

CARATTERISTICHE

Base (mm) **50**
 Rotazione canna **360°**
 Tipologia flessibile **Inox 3/8"**
 Lunghezza flessibile **350 mm**
 Cartuccia (ø mm) **35**
 Foro top (mm) **35**











FINITURE

Euro **315**

 **Cromato** **CR** **MIKSTRCR**

COLORE *

Euro **360**

-  **Black** **K86** **MKKSTR86**
-  **White** **K96** **MKKSTR96**
-  **Dark Grey** **K99** **MKKSTR99**
-  **Titanium** **M73** **MMKSTR73**
-  **Aluminium** **M79** **MMKSTR79**
-  **Nero** **G40** **MGKSTR40**
-  **Tortora** **G43** **MGKSTR43**
-  **Cemento** **G48** **MGKSTR48**
-  **Bianco** **G68** **MGKSTR68**
-  **Espresso** **G78** **MGKSTR78**
-  **Avena** **G51** **MGKSTR51**

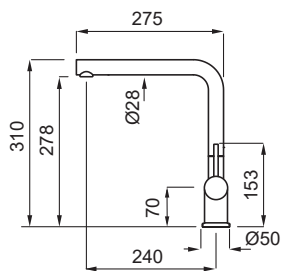

CR Cromato

STREAM PLUS



Black
K86

Miscelatore monocomando con canna girevole e doccetta estraibile

CARATTERISTICHE

Base (mm) **50**
 Rotazione canna **360°**
 Tipologia flessibile **Inox 3/8"**
 Lunghezza flessibile **350 mm**
 Cartuccia (ø mm) **35**
 Foro top (mm) **35**















FINITURE

Euro **364**

 **Cromato** **CR** **MIKSTPCR**

COLORE *

Euro **413**

-  **Black** **K86** **MKKSTP86**
-  **Dove Grey** **K93** **MKKSTP93**
-  **Champagne** **K95** **MKKSTP95**
-  **White** **K96** **MKKSTP96**
-  **Light Grey** **K97** **MKKSTP97**
-  **Dark Grey** **K99** **MKKSTP99**
-  **Titanium** **M73** **MMKSTP73**
-  **Aluminium** **M79** **MMKSTP79**
-  **Nero** **G40** **MGKSTP40**
-  **Tortora** **G43** **MGKSTP43**
-  **Cemento** **G48** **MGKSTP48**
-  **Bianco** **G68** **MGKSTP68**
-  **Espresso** **G78** **MGKSTP78**
-  **Avena** **G51** **MGKSTP51**

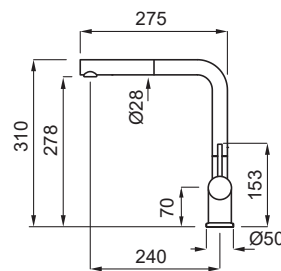

CR Cromato

* Colori abbinabili ai materiali Keratek e Granitek

TRAIL



Nero
G40

Miscelatore monocomando con canna girevole

CARATTERISTICHE

Base (mm) **50**
 Rotazione canna **360°**
 Tipologia flessibile **Inox 3/8"**
 Lunghezza flessibile **350 mm**
 Cartuccia (ø mm) **35**
 Foro top (mm) **35**

FINITURE

Cromato CR MIKTRACR **Euro 216**

COLORE *

- | | | |
|--|--------------------------|----------|
| | Black K86 | MKKTRA86 |
| | Dove Grey K93 | MKKTRA93 |
| | Champagne K95 | MKKTRA95 |
| | White K96 | MKKTRA96 |
| | Light Grey K97 | MKKTRA97 |
| | Dark Grey K99 | MKKTRA99 |
| | Titanium M73 | MMKTRA73 |
| | Aluminium M79 | MMKTRA79 |
| | Nero G40 | MGKTRA40 |
| | Tortora G43 | MGKTRA43 |
| | Cemento G48 | MGKTRA48 |
| | Bianco G68 | MGKTRA68 |
| | Espresso G78 | MGKTRA78 |
| | Avena G51 | MGKTRA51 |
| | Antracite G59 | MGKTRA59 |
| | Bianco Antico G62 | MGKTRA62 |

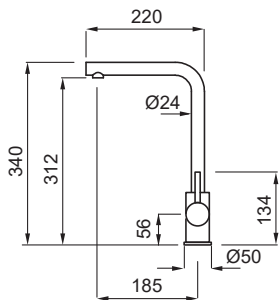

CR Cromato

TRAIL PLUS



Bianco
G68

Miscelatore monocomando con canna girevole e doccetta estraibile

CARATTERISTICHE

Base (mm) **50**
 Rotazione canna **360°**
 Tipologia flessibile **Inox 3/8"**
 Lunghezza flessibile **400 mm**
 Cartuccia (ø mm) **35**
 Foro top (mm) **35**

FINITURE

Cromato CR MIKTRPCR **Euro 292**

COLORE *

- | | | |
|--|--------------------------|----------|
| | Black K86 | MKKTRP86 |
| | White K96 | MKKTRP96 |
| | Titanium M73 | MMKTRP73 |
| | Aluminium M79 | MMKTRP79 |
| | Nero G40 | MGKTRP40 |
| | Tortora G43 | MGKTRP43 |
| | Cemento G48 | MGKTRP48 |
| | Bianco G68 | MGKTRP68 |
| | Espresso G78 | MGKTRP78 |
| | Avena G51 | MGKTRP51 |
| | Antracite G59 | MGKTRP59 |
| | Bianco Antico G62 | MGKTRP62 |

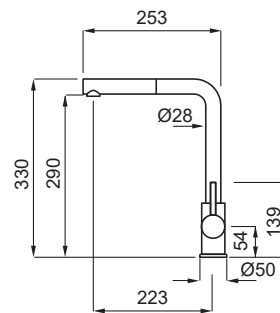

CR Cromato

* Colori abbinabili ai materiali Keratek e Granitek

MISCELATORI

MISCELATORI TOURMALINE



Miscelatore filtrante monocomando con canna girevole

CARATTERISTICHE

Base (mm)	50
Rotazione canna	360°
Tipologia flessibile	Inox 3/8"
Lunghezza flessibile	400 mm
Cartuccia (ø mm)	35
Foro top (mm)	35





FINITURE

Euro **311**

	Inox IN	MIKTOUIN
---	----------------	----------

COLORE *

Euro **311**

	Black K86	MKKTOU86
	White K96	MKKTOU96
	Nero G40	MGKTOU40
	Bianco G68	MGKTOU68
	Avena G51	MGKTOU51

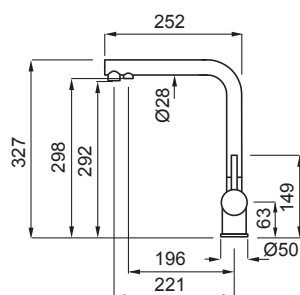

SISTEMA DI FILTRAGGIO

Il sistema filtrante Elleci trasforma il rubinetto della tua cucina in una sorgente d'acqua fresca e depurata. Un miscelatore con sistema filtrante riduce il contenuto di metalli pesanti, cloro e calcare presenti nell'acqua del rubinetto ed è pratico da utilizzare poiché il filtro è collegato direttamente al rubinetto dell'impianto idrico di casa e fornisce in tal modo acqua filtrata ogni volta che serve.

La cartuccia di ricambio del filtro assicura una capacità filtrante di 4.000 litri (consigliata la sostituzione almeno a cadenza annuale):

- Durata fino a 4.000 litri / 6 mesi

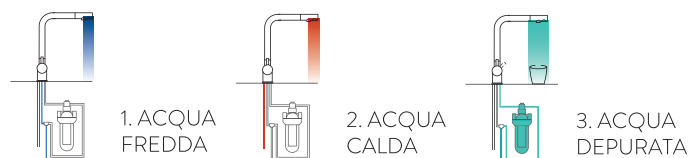

ACCESSORI



Kit Filtraggio
AF101300
Euro **160**



Ricambio Filtro
RFP01300
Euro **83**

* Colori abbinabili ai materiali Keratek e Granitek

ATHENA

ATHENA PLUS NEW



Miscelatore monocomando con canna girevole

Miscelatore monocomando con canna girevole e doccetta estraibile

CARATTERISTICHE

Base (mm) **35**
 Rotazione canna **360°**
 Tipologia flessibile **Inox 3/8"**
 Lunghezza flessibile **500 mm**
 Cartuccia (ø mm) **25**
 Foro top (mm) **48**

FINITURE Euro 290

Cromato CR MIKATHCR

COLORE * Euro 363

- Titanium M73** MMKATH73
- Aluminium M79** MMKATH79
- Nero G40** MGKATH40
- Tortora G43** MGKATH43
- Cemento G48** MGKATH48
- Bianco G68** MGKATH68

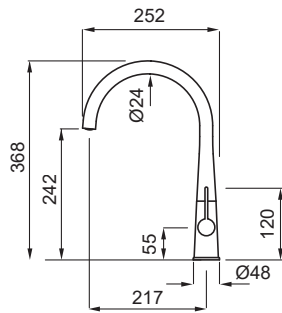

CR Cromato

CARATTERISTICHE

Base (mm) **35**
 Rotazione canna **360°**
 Tipologia flessibile **Inox 3/8"**
 Lunghezza flessibile **500 mm**
 Cartuccia (ø mm) **25**
 Foro top (mm) **48**

FINITURE Euro 320

Cromato CR MIKATPCR

COLORE * Euro 390

- Titanium M73** MMKATP73
- Aluminium M79** MMKATP79
- Nero G40** MGKATP40
- Tortora G43** MGKATP43
- Cemento G48** MGKATP48
- Bianco G68** MGKATP68

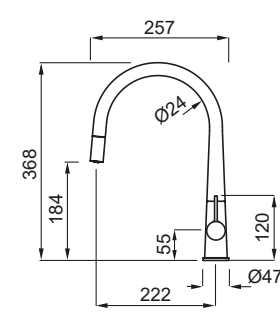

CR Cromato

* Colori abbinabili ai materiali Keratek e Granitek

MISCELATORI

MISCELATORI ADIGE



White
K96

Miscelatore monocomando con canna girevole

CARATTERISTICHE

Base (mm) **50**
 Rotazione canna **360°**
 Tipologia flessibile **Inox 3/8"**
 Lunghezza flessibile **400 mm**
 Cartuccia (ø mm) **35**
 Foro top (mm) **35**

FINITURE Euro 317

Inox IN MIKADIIN

COLORE * Euro 317

Black K86 MKKADI86
White K96 MKKADI96
Nero G40 MGKADI40
Bianco G68 MGKADI68

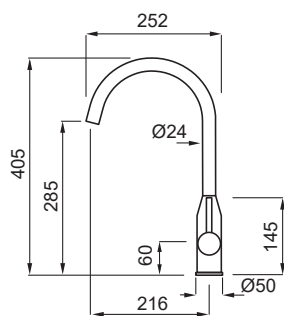

DORA PLUS



Inox
IN

Miscelatore monocomando con canna girevole e doccetta estraibile

CARATTERISTICHE

Base (mm) **50**
 Rotazione canna **360°**
 Tipologia flessibile **Inox 3/8"**
 Lunghezza flessibile **400 mm**
 Cartuccia (ø mm) **35**
 Foro top (mm) **35**

FINITURE Euro 386

Inox IN MIKDRPIN

COLORE * Euro 386

Black K86 MKKDRP86
White K96 MKKDRP96
Nero G40 MGKDRP40
Bianco G68 MGKDRP68

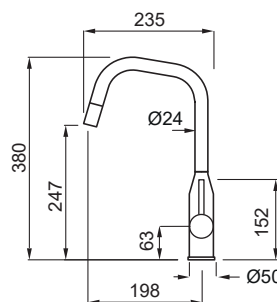

* Colori abbinabili ai materiali Keratek e Granitek

CLUB NEW





Gold
GD

Miscelatore monocomando con canna girevole

CARATTERISTICHE

Base (mm) **47**
 Rotazione canna **360°**
 Tipologia flessibile **Inox 3/8"**
 Lunghezza flessibile **390 mm**
 Cartuccia (ø mm) **25**
 Foro top (mm) **35**

FINITURE Euro **398**

 **Cr. Spazzolato** MIKCLUCS
 CS
 **Gold** MOKCLUGD
 GD

COLORE * Euro **318**

 **Black** MOKCLUBK
 BK

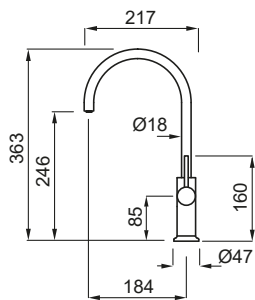

CS Cr. Spazzolato

BRIDGE



Nero
G40

Miscelatore monocomando con canna girevole



CARATTERISTICHE

Base (mm) **50**
 Rotazione canna **360°**
 Tipologia flessibile **Inox 3/8"**
 Lunghezza flessibile **350 mm**
 Cartuccia (ø mm) **35**
 Foro top (mm) **35**

FINITURE Euro **234**

 **Cromato** MIKBRICR
 CR

COLORE * Euro **281**

 **Black** MKKBRI86
 K86
 **White** MKKBRI96
 K96
 **Titanium** MMKBRI73
 M73
 **Aluminium** MMKBRI79
 M79
 **Nero** MGKBRI40
 G40
 **Tortora** MGKBRI43
 G43
 **Cemento** MGKBRI48
 G48
 **Bianco** MGKBRI68
 G68
 **Avena** MGKBRI51
 G51

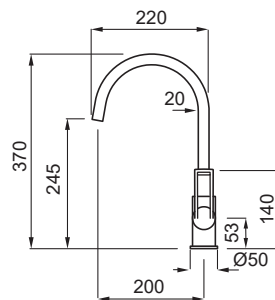

CR Cromato

* Colori abbinabili ai materiali Keratek e Granitek

MISCELATORI VOLTA



Miscelatore monocomando con canna girevole

CARATTERISTICHE

Base (mm) **45**
 Rotazione canna **360°**
 Tipologia flessibile **Inox 3/8"**
 Lunghezza flessibile **350 mm**
 Cartuccia (ø mm) **35**
 Foro top (mm) **35**









FINITURE

Euro **287**

 **Cromato** **CR** MIKVTA CR

COLORE *

Euro **356**

 **Black** **K86** MKKVTA86
 **White** **K96** MKKVTA96
 **Titanium** **M73** MMKVTA73
 **Aluminium** **M79** MMKVTA79
 **Nero** **G40** MGKVTA40
 **Tortora** **G43** MGKVTA43
 **Cemento** **G48** MGKVTA48
 **Bianco** **G68** MGKVTA68

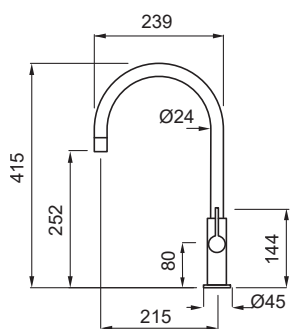

CR Cromato

CLOUD



Miscelatore monocomando con canna girevole

CARATTERISTICHE

Base (mm) **48**
 Rotazione canna **360°**
 Tipologia flessibile **Inox 3/8"**
 Lunghezza flessibile **390 mm**
 Cartuccia (ø mm) **35**
 Foro top (mm) **35**

















FINITURE

Euro **198**

 **Cromato** **CR** MIKCLO CR

COLORE *

Euro **254**

 **Black** **K86** MKKCLO86
 **Dove Grey** **K93** MKKCLO93
 **Champagne** **K95** MKKCLO95
 **White** **K96** MKKCLO96
 **Light Grey** **K97** MKKCLO97
 **Dark Grey** **K99** MKKCLO99
 **Titanium** **M73** MMKCLO73
 **Aluminium** **M79** MMKCLO79
 **Nero** **G40** MGKCLO40
 **Tortora** **G43** MGKCLO43
 **Cemento** **G48** MGKCLO48
 **Bianco** **G68** MGKCLO68
 **Espresso** **G78** MGKCLO78
 **Avena** **G51** MGKCLO51
 **Antracite** **G59** MGKCLO59
 **Bianco Antico** **G62** MGKCLO62

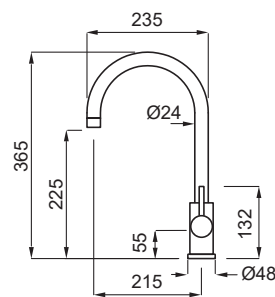

CR Cromato

* Colori abbinabili ai materiali Keratek e Granitek

NEVA



Miscelatore monocomando con canna girevole e doccetta estraibile

CARATTERISTICHE

Base (mm) **50**
 Rotazione canna **360°**
 Tipologia flessibile **Inox 3/8"**
 Lunghezza flessibile **400 mm**
 Cartuccia (ø mm) **35**
 Foro top (mm) **35**

FINITURE

Inox IN MIKNEVIN Euro **318**

COLORE *

Nero G40 MGKNEV40 Euro **318**
Bianco G68 MGKNEV68
Avena G51 MGKNEV51
Antracite G59 MGKNEV59
Bianco Antico G62 MGKNEV62

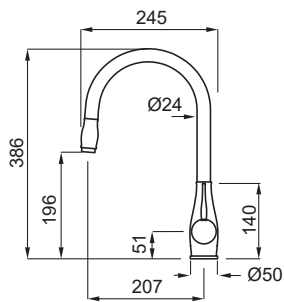

DANUBIO



Miscelatore monocomando reclinabile con canna girevole

CARATTERISTICHE

Base (mm) **50**
 Rotazione canna **360°**
 Tipologia flessibile **Inox 3/8"**
 Lunghezza flessibile **350 mm**
 Cartuccia (ø mm) **40**
 Foro top (mm) **35**

FINITURE

Cromato CR MIKDANCR Euro **370**

COLORE *

Nero G40 MGKDAN40 Euro **412**
Bianco G68 MGKDAN68
Avena G51 MGKDAN51

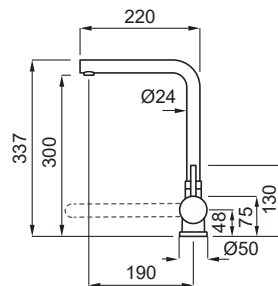

CR Cromato

* Colori abbinabili ai materiali Keratek e Granitek

MISCELATORI

MISCELATORI SAVA

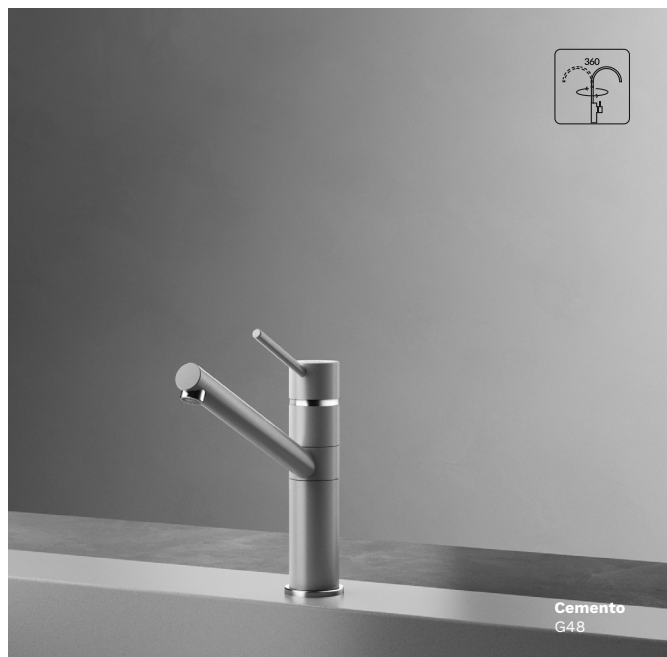

Miscelatore monocomando con canna girevole

CARATTERISTICHE

Base (mm) **50**
 Rotazione canna **360°**
 Tipologia flessibile **Inox 3/8"**
 Lunghezza flessibile **350 mm**
 Cartuccia (ø mm) **35**
 Foro top (mm) **35**

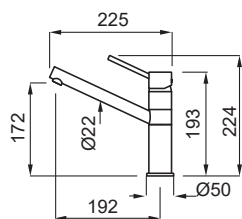

CR Cromato

FINITURE Euro 221

Cromato MKKSAVCR
 CR

COLORE * Euro 270

- Black** MKKSAV86
K86
- White** MKKSAV96
K96
- Titanium** MMKSAV73
M73
- Aluminium** MMKSAV79
M79
- Nero** MGKSAV40
G40
- Tortora** MGKSAV43
G43
- Cemento** MGKSAV48
G48
- Bianco** MGKSAV68
G68
- Espresso** MGKSAV78
G78
- Avena** MGKSAV51
G51
- Antracite** MGKSAV59
G59
- Bianco Antico** MGKSAV62
G62

RENO



Miscelatore monocomando con canna girevole e doccetta estraibile

CARATTERISTICHE

Base (mm) **50**
 Rotazione canna **360°**
 Tipologia flessibile **Inox 3/8"**
 Lunghezza flessibile **350 mm**
 Cartuccia (ø mm) **35**
 Foro top (mm) **35**

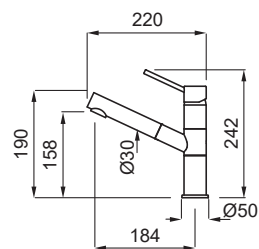

CR Cromato

FINITURE Euro 276

Cromato MIKRENCR
 CR

COLORE * Euro 328

- Black** MKKREN86
K86
- White** MKKREN96
K96
- Titanium** MMKREN73
M73
- Aluminium** MMKREN79
M79
- Nero** MGKREN40
G40
- Tortora** MGKREN43
G43
- Cemento** MGKREN48
G48
- Bianco** MGKREN68
G68
- Espresso** MGKREN78
G78
- Avena** MGKREN51
G51
- Antracite** MGKREN59
G59
- Bianco Antico** MGKREN62
G62

* Colori abbinabili ai materiali Keratek e Granitek

SENNA



Miscelatore monocomando con canna girevole

CARATTERISTICHE

Base (mm) **54**
 Rotazione canna **360°**
 Tipologia flessibile **Inox 3/8"**
 Lunghezza flessibile **350 mm**
 Cartuccia (ø mm) **35**
 Foro top (mm) **35**

FINITURE

Euro 174

 **Cromato** MIKSENCR

COLORE *

Euro 222

 **Nero** MGKSEN40

 **Bianco** MGKSEN68

 **Avena** MGKSEN51

 **Antracite** MGKSEN59

 **Bianco Antico** MGKSEN62

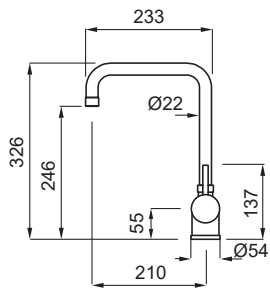

CR Cromato

PO



Miscelatore monocomando con canna girevole

CARATTERISTICHE

Base (mm) **51**
 Rotazione canna **360°**
 Tipologia flessibile **Inox 3/8"**
 Lunghezza flessibile **330 mm**
 Cartuccia (ø mm) **35**
 Foro top (mm) **35**

FINITURE

Euro 190

 **Cromato** MIKPOCR

COLORE *

Euro 213

 **Titanium** MMKPO73

 **Aluminium** MMKPO79

 **Nero** MGKPO40

 **Bianco** MGKPO68

 **Avena** MGKPO51

 **Antracite** MGKPO59

 **Bianco Antico** MGKPO62

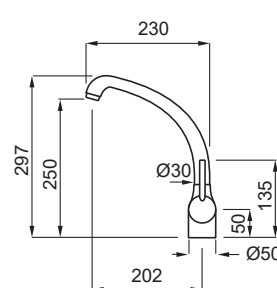

CR Cromato

* Colori abbinabili ai materiali Keratek e Granitek

MISCELATORI

MISCELATORI MINERVA



Miscelatore monocomando con canna girevole

CARATTERISTICHE

Base (mm)	50
Rotazione canna	360°
Tipologia flessibile	Inox 3/8"
Lunghezza flessibile	400 mm
Cartuccia (ø mm)	40
Foro top (mm)	35

FINITURE

Euro **105**

	Cromato CR	MIKMINCR
---	----------------------	----------

COLORE *

Euro **146**

	Titanium M73	MMKMIN73
	Aluminium M79	MMKMIN79
	Nero G40	MGKMIN40
	Bianco G68	MGKMIN68
	Avena G51	MGKMIN51
	Antracite G59	MGKMIN59
	Bianco Antico G62	MGKMIN62

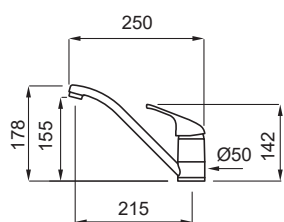

CR Cromato

VENERE

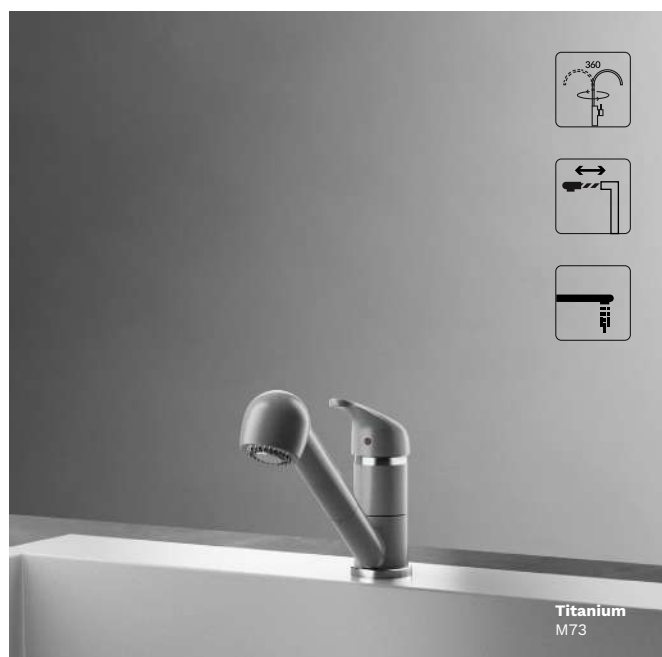

Miscelatore monocomando con canna girevole e doccetta estraibile doppio getto

CARATTERISTICHE

Base (mm)	55
Rotazione canna	360°
Tipologia flessibile	Inox 3/8"
Lunghezza flessibile	350 mm
Cartuccia (ø mm)	35
Foro top (mm)	35







FINITURE

Euro **152**

	Cromato CR	MIKVENCR
---	----------------------	----------

COLORE *

Euro **190**

	Titanium M73	MMKVEN73
	Aluminium M79	MMKVEN79
	Bianco G68	MGKVEN68
	Avena G51	MGKVEN51
	Antracite G59	MGKVEN59
	Bianco Antico G62	MGKVEN62

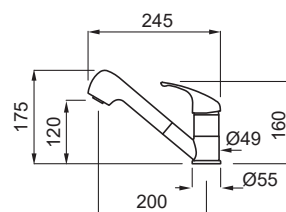

CR Cromato

* Colori abbinabili ai materiali Keratek e Granitek

RIO



Bianco Antico
G62

Miscelatore monocomando con canna girevole

CARATTERISTICHE

Base (mm)	54
Rotazione canna	360°
Tipologia flessibile	Inox 3/8"
Lunghezza flessibile	350 mm
Cartuccia (ø mm)	35
Foro top (mm)	35

FINITURE

	Cromato CR	Euro 315 MIKRIOCR
---	----------------------	-----------------------------

	Rame RA	Euro 336 MIKRIORA
---	-------------------	-----------------------------

COLORE *

	Avena G51	Euro 336 MGKRIO51
	Antracite G59	MGKRIO59
	Bianco Antico G62	MGKRIO62

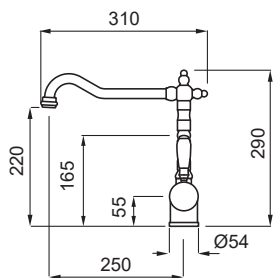

CR Cromato

* Colori abbinabili ai materiali Keratek e Granitek



MISCELATORI

COLLEZIONE
ELDOM
URBAN



**URBAN
GAS ON GLASS 75**

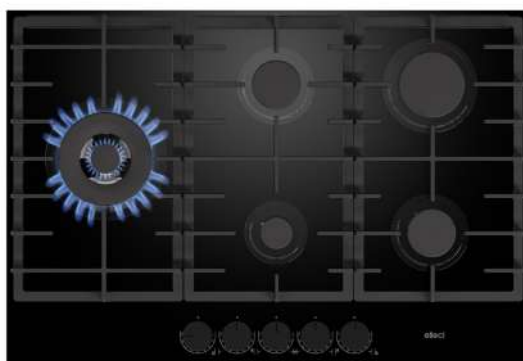

TOTAL BLACK GLASS

Una combinazione profonda e brillante allo stesso tempo. La famiglia di prodotti Urban è caratterizzata dall'unione del materiale vetro e il colore nero per un risultato elegante, lineare e pulito.



FULL COLOR MATCHING

Abbinamento totale.

Piano cottura, lavello, miscelatore e forno uniti da un unico colore.

Il lavello e il miscelatore sono verniciati in ogni loro parte del colore di riferimento, il forno si abbinerà attraverso la cornice laterale, mentre il piano cottura attraverso la base di appoggio.



PLANO 75



Piano cottura a induzione in vetroceramica da 80 cm

CARATTERISTICHE

4 zone cottura con funzione **Bridge**

- 2 * - 210 mm
- 3.0 kW + Ø 250 mm
- 2.3 kW + Ø 145 mm
- 1.4 kW

Comando **Stop-Go** di sospensione e riavvio cottura.

Led bianchi.

Comandi slider.

Fino a 9 livelli di potenza.

Limitatore di potenza programmabile su 8 livelli (1.0 - 1.5 - 2.8 - 3.5 - 3.7 - 4.5 - 6.0 - 7.4 kW).

Potenza massima 7.4 kW.

Programmazione digitale del tempo di cottura indipendente per ciascuna zona.

Funzione timer con allarme acustico.

Spegnimento automatico.

Rilevazione presenza pentola.

FINITURE

Black
K86

Euro 1.940

PVIU801BK

SICUREZZA

Indicatore calore residuo.

Blocco di sicurezza bambini.

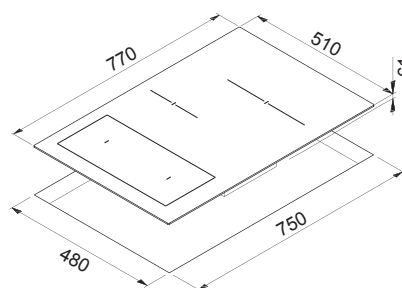

PLUS

1 kW LIMITATORE DI POTENZA

+ BRIDGE ZONE

↔ SLIDING TOUCH CONTROL

>|| STOP GO

LED WHITE LED

PLUS



URBAN 60 **NEW**

60



Piano cottura a induzione in vetroceramica da 60 cm

CARATTERISTICHE

4 zone cottura con funzione **Bridge**

- 2 * - 210 mm
- 3.0 kW + Ø 200 mm
- 2.3 kW + Ø 145 mm
- 1.4 kW

Comando **Stop-Go** di sospensione e riavvio cottura.

Led bianchi.

Comandi slider.

Fino a 9 livelli di potenza.

Limitatore di potenza programmabile su 8 livelli (1.0 - 1.5 - 2.8 - 3.5 - 3.7 - 4.5 - 6.0 - 7.4 kW).

Potenza massima 7.4 kW.

Programmazione digitale del tempo di cottura indipendente per ciascuna zona.

Funzione timer con allarme acustico.

Spegnimento automatico.

Rilevazione presenza pentola.

FINITURE



Euro 1.825

PVIU601BK

SICUREZZA

Indicatore calore residuo.

Blocco di sicurezza bambini.

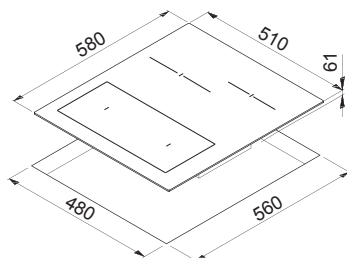

PLUS



URBAN 30 **NEW**

30



Piano cottura a induzione in vetroceramica da 30 cm

CARATTERISTICHE

2 zone cottura con funzione **Bridge**

- 2 * - 210 mm
- Comando **Stop-Go** di sospensione e riavvio cottura.

Led bianchi.

Comandi slider.

Fino a 9 livelli di potenza.

Limitatore di potenza programmabile su 8 livelli (1.0 - 1.5 - 2.8 - 3.5 - 3.7 kW).

Potenza massima 3.7 kW.

Programmazione digitale del tempo di cottura indipendente per ciascuna zona.

Funzione timer con allarme acustico.

Spegnimento automatico.

Rilevazione presenza pentola.

FINITURE



Euro 1.230

PVIU301BK

SICUREZZA

Indicatore calore residuo.

Blocco di sicurezza bambini.

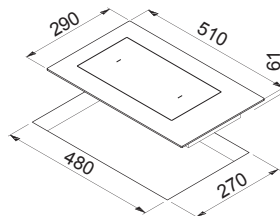

PLUS



COLLEZIONE
PIANI
GAS ON GLASS

URBAN 90 **NEW**

90



Piano cottura a gas in cristallo temperato da 90 cm

CARATTERISTICHE

5 Bruciatori a gas

- 1 Ausiliario 1 kW
- 2 Semirapido 1,75 kW
- 1 Rapido 2 kW

• **1 Bruciatore Wok 4 kW posizione laterale sinistra**

Griglie d'appoggio e copri-spartifiamma in ghisa per una migliore trasmissione del calore senza sprechi e dispersioni. Manopole nere soft touch per una migliore piacevolezza d'uso.

Step Flame Control: 9 livelli di potenza per il minimo spreco energetico.

Accensione elettrica sottomanopola. Kit ugelli GPL in dotazione.

FINITURE

Black
K86

Euro 1.050

PVGU901BK

SICUREZZA

Termovalvola di sicurezza.

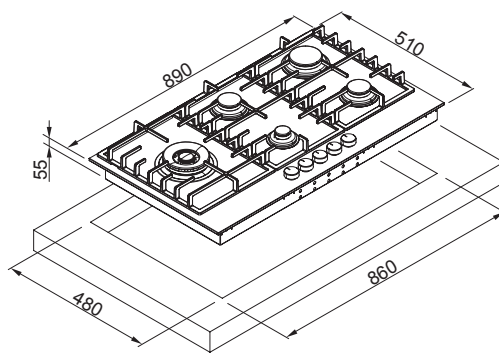

PLUS



**GRIGLIE
IN GHISA**



**STEP FLAME
CONTROL**



**MANOPOLE NERE
SOFT TOUCH**



**BRUCIATORE
WOK**

PLUS



URBAN 75 NEW

75



Piano cottura a gas in cristallo temperato da 75 cm

CARATTERISTICHE

- 5 Bruciatori a gas
- 1 Ausiliario 1 kW
- 2 Semirapido 1,75 kW
- 1 Rapido 2 kW
- **1 Bruciatore Wok 4 kW posizione laterale sinistra**

Griglie d'appoggio e copri-spartifiamma in ghisa per una migliore trasmissione del calore senza sprechi e dispersioni. Manopole nere soft touch per una migliore piacevolezza d'uso.

Step Flame Control: 9 livelli di potenza per il minimo spreco energetico. Accensione elettrica sottomanopola. Kit ugelli GPL in dotazione.

FINITURE



Black
K86

Euro 998

PVGU751BK

SICUREZZA

Termovalvola di sicurezza.

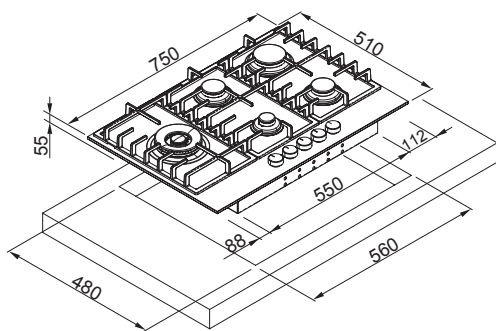

PLUS



URBAN 60 NEW

60



Piano cottura a gas in cristallo temperato da 60 cm

CARATTERISTICHE

- 4 Bruciatori a gas
- 1 Ausiliario 1 kW
- 2 Semirapido 1,75 kW
- 1 Rapido 3 Kw

Griglie d'appoggio e copri-spartifiamma in ghisa per una migliore trasmissione del calore senza sprechi e dispersioni. Manopole nere soft touch per una migliore piacevolezza d'uso.

Step Flame Control: 9 livelli di potenza per il minimo spreco energetico. Accensione elettrica sottomanopola. Kit ugelli GPL in dotazione.

FINITURE



Black
K86

Euro 775

PVGU601BK

SICUREZZA

Termovalvola di sicurezza.

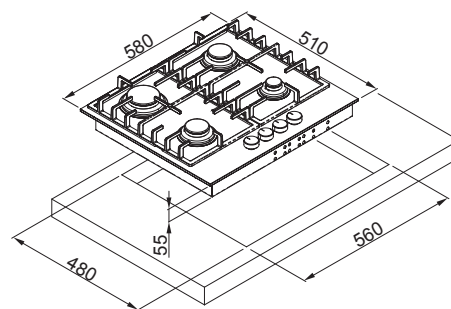

PLUS



PLANO PLUS 75

75



Piano cottura a gas smaltato da 75 cm

CARATTERISTICHE

5 Bruciatori a gas

- 1 Ausiliario 1 kW
- 2 Semirapido 1,75 kW
- 1 Rapido 3 kW

• **1 Bruciatore Wok 4 kW posizione centrale**

Griglie d'appoggio e copri-spartifiamma in ghisa per una migliore trasmissione del calore senza sprechi e dispersioni.

Manopole nere soft touch per una migliore piacevolezza d'uso.

Step Flame Control: 9 livelli di potenza per il minimo spreco energetico.

FLAT BURNER FULL BLACK.

Accensione elettrica integrata sottomanopola.

Kit ugelli GPL in dotazione.

SICUREZZA

Termovalvola di sicurezza.

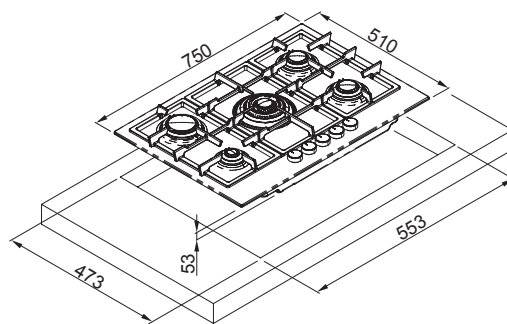

PLUS



COLORI*



Euro 1.030

● **Light Grey** PKPP75197CS
K97



Euro 1.030

○ **White** PKPP75196CS
K96



Euro 1.030

● **Dove Grey** PKPP75193CS
K93



Euro 1.030

● **Black** PKPP75186CS
K86



Euro 1.030

○ **Bianco** PGPP75168CS
G68



Euro 1.030

● **Nero** PGPP75140CS
G40

PLUS



GRIGLIE IN GHISA



STEP FLAME CONTROL



FLAT BURNER



ACCENSIONE INTEGRATA SOTTOMANOPOLA



CORONA WOK

Bruciatore doppia corona Wok



Manopole nere soft touch



*Colori abbinabili ai materiali Keratek e Granitek

PLANO 90

90

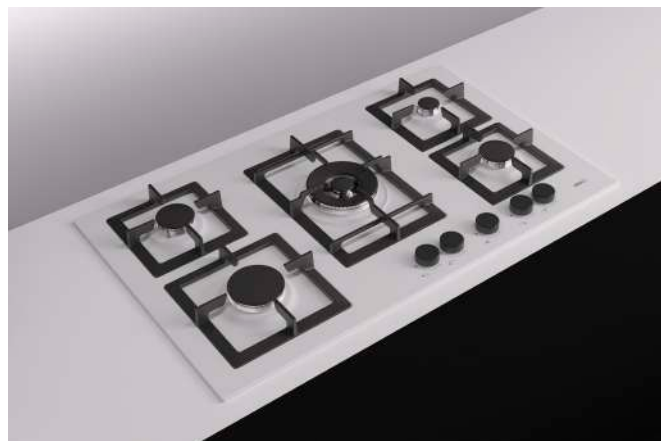

Piano cottura a gas smaltato da 90 cm

CARATTERISTICHE

5 Bruciatori a gas

- 1 Ausiliario 1 kW
- 2 Semirapido 1,75 kW
- 1 Rapido 3 kW

- **1 Bruciatore Wok 4 kW posizione centrale**

Griglie d'appoggio e copri-spartifiamma in ghisa per una migliore trasmissione del calore senza sprechi e dispersioni.

Manopole nere soft touch per una migliore piacevolezza d'uso.

Accensione elettrica integrata sottomanopola.

Kit ugelli GPL in dotazione.

SICUREZZA

Termovalvola di sicurezza.

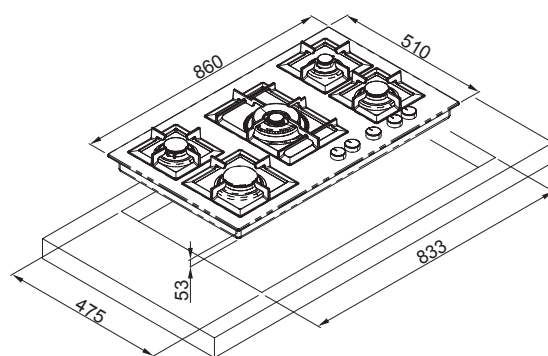

PLUS



COLORI*



Euro 748

Bianco
G68

PGSP90168CS



Euro 748

Nero
G40

PGSP90140CS

PLUS



**GRIGLIE IN
GHISA**



**ACCENSIONE INTEGRATA
SOTTOMANOPIOLA**



**CORONA
WOK**

Griglie in ghisa



Manopole nere soft touch



*Colori abbinabili ai materiali Keratek e Granitek

PLANO 75

75



Piano cottura a gas smaltato da 75 cm

CARATTERISTICHE

5 Bruciatori a gas

- 1 Ausiliario 1 kW
- 2 Semirapido 1,75 kW
- 1 Rapido 3 kW

• **1 Bruciatore Wok 4 kW posizione centrale**

Accensione sottomanopola

Griglie d'appoggio e copri-spartifiamma in ghisa per una migliore trasmissione del calore senza sprechi e dispersioni.

Manopole nere soft touch per una migliore piacevolezza d'uso.

Accensione elettrica integrata sottomanopola.

Kit ugelli GPL in dotazione.

SICUREZZA

Termovalvola di sicurezza.

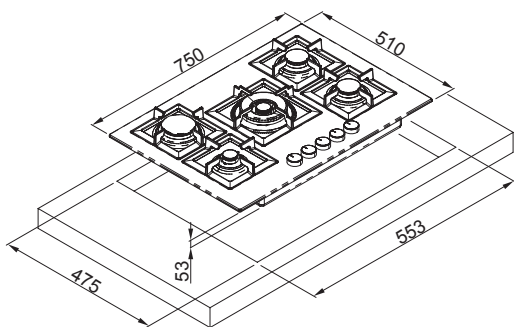

PLUS



COLORI*

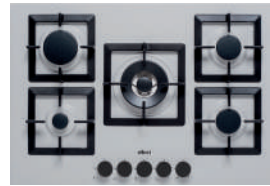

Euro 690

Aluminium PMSP75179CS
M79



Euro 690

Titanium PMSP75173CS
M73



Euro 674

Bianco PGSP75168CS
G68



Euro 674

Avena PGSP75151CS
G51



Euro 674

Tortora PGSP75143CS
G43



Euro 674

Nero PGSP75140CS
G40

FINITURE



Euro 680

Inox PIAP751INCS
IN

*Colori abbinabili ai materiali Granitek

PLANO 60

60

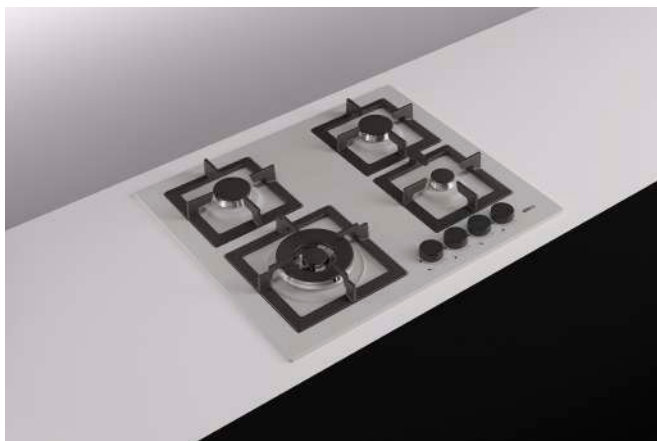

Piano cottura a gas smaltato da 60 cm

CARATTERISTICHE

4 Bruciatori a gas

- 1 Ausiliario 1 kW
- 2 Semirapido 1,75 kW

• **1 Bruciatore Wok 3.1 kW posizione laterale sinistra**

Griglie d'appoggio e copri-spartifiamma in ghisa per una migliore trasmissione del calore senza sprechi e dispersioni.

Manopole nere soft touch per una migliore piacevolezza d'uso.

Accensione elettrica sottomanopola.

Kit ugelli GPL in dotazione.

SICUREZZA

Termovalvola di sicurezza.

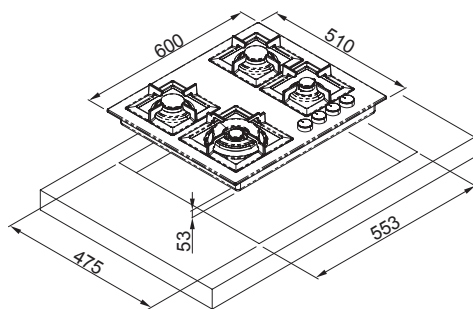

PLUS



COLORI*



Euro 617

Aluminium PMSP60179WS
M79



Euro 617

Titanium PMSP60173WS
M73



Euro 602

Bianco PGSP60168WS
G68



Euro 602

Avena PGSP60151WS
G51

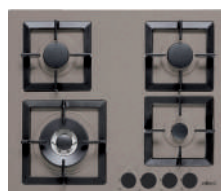

Euro 602

Tortora PGSP60143WS
G43



Euro 602

Nero PGSP60140WS
G40

FINITURE



Euro 608

Inox PIAP601INWS
IN

*Colori abbinabili ai materiali Granitek

STYLE 75

75



Piano cottura a gas smaltato da 75 cm

CARATTERISTICHE

5 Bruciatori a gas

- 1 Ausiliario 1 kW
- 2 Semirapido 1,75 kW
- 1 Rapido 3 kW

- **1 Bruciatore Wok 4 kW posizione centrale.**

Griglie lamellari.

Manopole nere soft touch per una migliore piacevolezza d'uso.

Accensione elettrica integrata sottomanopola.
Kit ugelli GPL in dotazione.

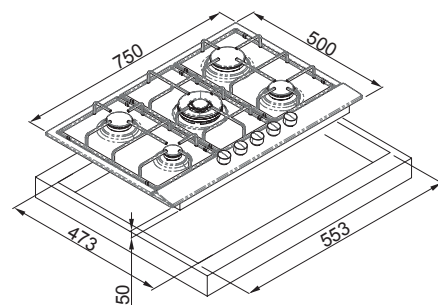

SICUREZZA

Termovalvola di sicurezza.

COLORI*



Euro 626

 **Bianco** PGSS75368CB
G68



Euro 626

 **Antracite** PGSS75359CB
G59



Euro 626

 **Avena** PGSS75351CB
G51



Euro 626

 **Cemento** PGSS75348CB
G48

PLUS



* Colori abbinabili ai materiali Granitek

STYLE 60

60



Piano cottura a gas smaltato da 60 cm

CARATTERISTICHE

- 4 Bruciatori a gas
 - 1 Ausiliario 1 kW
 - 2 Semirapido 1,75 kW
 - 1 Rapido 3 kW
- Griglie lamellari.
Manopole nere soft touch per una migliore piacevolezza d'uso.
Accensione elettrica integrata sottomanopola.
Kit ugelli GPL in dotazione.

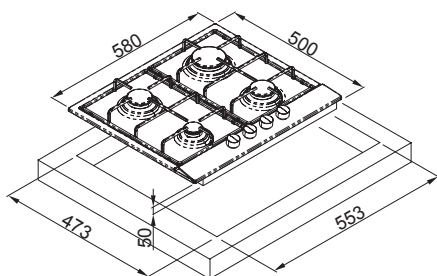

SICUREZZA

Termovalvola di sicurezza.

COLORI*

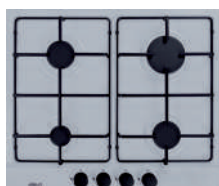

Euro 495

● **Bianco** PGSS60268WB
G68



Euro 495

● **Antracite** PGSS60259WB
G59



Euro 495

● **Avena** PGSS60251WB
G51



Euro 495

● **Cemento** PGSS60248WB
G48

PLUS



*Colori abbinabili ai materiali Granittek

PLUS



ACCENSIONE INTEGRATA SOTTOMANOPOLA



VALVOLA DI SICUREZZA



CORONA WOK

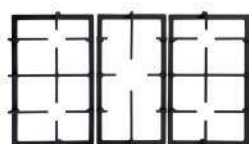

Griglie in ghisa Style 75

Euro 214

AKG03303

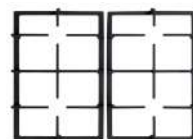

Griglie in ghisa Style 60

Euro 146

AKG01304



Piano cottura a gas smaltato da 90 cm

CARATTERISTICHE

- 5 Bruciatori a gas
- 1 Ausiliario 1 kW
- 2 Semirapido 1,75 kW
- 1 Rapido 3 kW
- **1 Bruciatore Wok 4 kW posizione centrale**

Griglie d'appoggio e copri-spartifiamma in ghisa per una migliore trasmissione del calore senza sprechi e dispersioni. Manopole nere soft touch per una migliore piacevolezza d'uso. Accensione elettrica sottomanopola. Kit ugelli GPL in dotazione.

COLORI*

 **Avena**
G51

Euro 710

PGCO90151WS

SICUREZZA

Termovalvola di sicurezza.

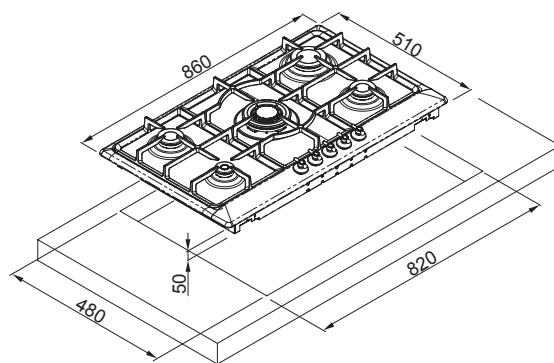

PLUS



* Colori abbinabili ai materiali Granitek

COUNTRY 75 NEW

75



Piano cottura a gas smaltato da 75cm

CARATTERISTICHE

- 5 Bruciatori a gas
- 1 Ausiliario 1 kW
- 2 Semirapido 1,75 kW
- 1 Rapido 3 kW

- **1 Bruciatore Wok 4 kW posizione laterale sinistra**

Griglie d'appoggio e copri-spartifiamma in ghisa per una migliore trasmissione del calore senza sprechi e dispersioni. Manopole nere soft touch per una migliore piacevolezza d'uso. Accensione elettrica sottomanopola. Kit ugelli GPL in dotazione.

COLORI*



Euro 698

PGCO75151WS

SICUREZZA

Termovalvola di sicurezza.

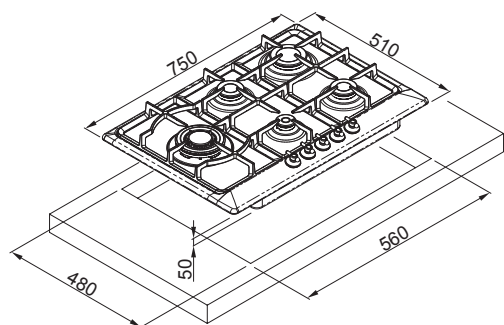

PLUS



*Colori abbinabili ai materiali Granitek

PLUS



GRIGLIE IN GHISA



ACCENSIONE INTEGRATA SOTTOMANOPOLA



CORONA WOK



Forno elettrico termoventilato 9 funzioni total black glass

CARATTERISTICHE

Classe energetica A.
Funzione **Steam Cleaning** pulizia a vapore.
Programmazione digitale 6 tasti led bianchi.
2 manopole nere soft touch per una migliore piacevolezza d'uso.
Maniglia total black.
Cavità XXL Black 80 litri easy to clean.
6 livelli di cottura.
1 griglia + 1 leccarda.
Luce forno.
Guide cromate laterali.
Porta interna removibile.

COLORI*

Black
BK

Euro 892

FVUP601BKNB

SICUREZZA

Porta fredda con triplo vetro.
Ventilazione tangenziale di raffreddamento.

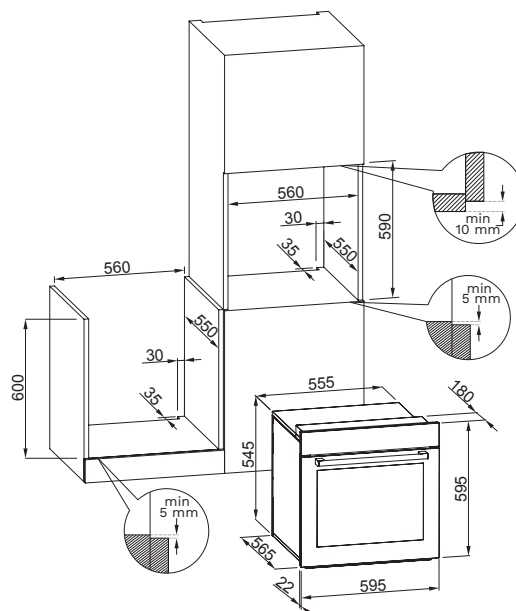

FUNZIONI



PLUS



PLUS



PORTA FREDDA



VETRO PORTA REMOVIBILE



CAVITÀ XXL



DISPLAY LED BIANCHI



MANOPOLE SOFT TOUCH



TOTAL BLACK GLASS



MULTI FUNCTION



TOUCH CONTROL

URBAN NEW



Forno elettrico multifunzione 8 funzioni total black glass

CARATTERISTICHE

Classe energetica A.
 Timer meccanico.
 3 manopole nere soft touch per una migliore piacevolezza d'uso.
 Maniglia total black.
Cavità XXL Black 80 litri easy to clean.
 6 livelli di cottura.
 1 griglia + 1 leccarda.
 Luce forno.
 Guide cromate laterali.
 Porta interna removibile.

COLORI* Euro 711

Black FVUR601BKNB
 BK

SICUREZZA

Porta fredda con triplo vetro.
 Ventilazione tangenziale di raffreddamento.

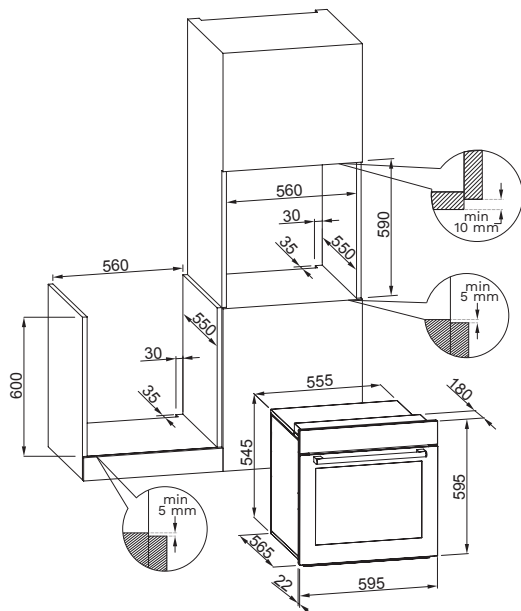

FUNZIONI

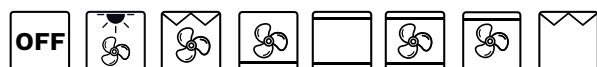

PLUS



URBAN MW NEW



Forno microonde multifunzione total black glass

CARATTERISTICHE

Capacità 28 L.
 Apertura porta a Sinistra.
 Programmatore elettronico con display digitale led bianchi.
 Cottura grill/combinata.
 Scongelo automatico in base a tempo e peso.
 Pulsante di avvio rapido.
 Piatto in vetro.
 Piatto girevole diametro 288 mm.
 Blocco di sicurezza.
 Griglia microonde.
 Touch Control.

COLORI* Euro 768

Black FVUR281BKWS
 BK

SICUREZZA

Funzione blocco bambini.

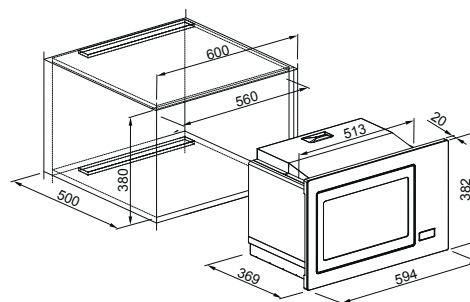

FUNZIONI



PLUS



FORNI



PLANO PLUS NEW



Forno elettrico termoventilato 9 funzioni

CARATTERISTICHE

Classe energetica A.

Funzione **Steam Cleaning** pulizia a vapore.
Programmazione digitale 6 tasti led bianchi.

2 manopole nere soft touch per una migliore piacevolezza d'uso.
Maniglia total black.

Cavità XXL Black 80 litri easy to clean.
6 livelli di cottura.

1 griglia + 1 leccarda.

Luce forno.

Guide cromate laterali.

Porta interna removibile.

Cornice frontale forno in colore.

SICUREZZA

Porta fredda con triplo vetro.

Ventilazione tangenziale di raffreddamento.

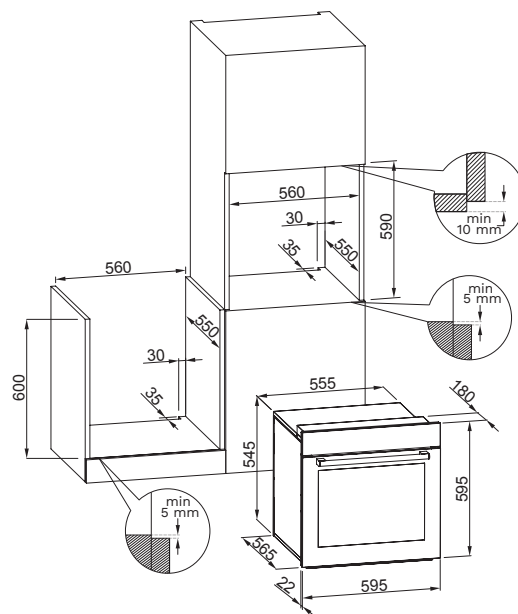

FUNZIONI



PLUS



COLORI*



Euro 972

● **Light Grey** FKPP60297NS
K97



Euro 972

○ **White** FKPP60296NS
K96



Euro 972

● **Dove Grey** FKPP60293NS
K93



Euro 972

● **Black** FKPP60286NS
K86



Euro 972

● **Aluminium** FMPP60279NS
M79



Euro 972

● **Titanium** FMPP60273NS
M73



Euro 972

○ **Bianco** FGPP60268NS
G68



Euro 972

● **Avena** FGPP60251NS
G51



Euro 972

● **Tortora** FGPP60243NS
G43



Euro 972

● **Nero** FGPP60240NS
G40

FINITURE



Euro 926

● **Inox** FIPP602INNS
IN

*Colori abbinabili ai materiali Keratek e Granitek

PLUS



PORTA FREDDA



VETRO PORTA REMOVIBILE



CAVITÀ XXL



DISPLAY LED BIANCHI



MANOPOLE SOFT TOUCH

COLLEZIONE
FORNI
 PLANO



PLANO NEW



Forno elettrico multifunzione 8 funzioni

CARATTERISTICHE

- Classe energetica A.
- Timer meccanico.
- 3 manopole nere soft touch per una migliore piacevolezza d'uso.
- Maniglia total black.
- Cavità XXL** Black 80 litri easy to clean.
- 6 livelli di cottura.
- 1 griglia + 1 leccarda.
- Luce forno.
- Guide cromate laterali.
- Porta interna removibile.
- Cornice frontale forno in colore.

SICUREZZA

- Porta fredda con triplo vetro.
- Ventilazione tangenziale di raffreddamento.

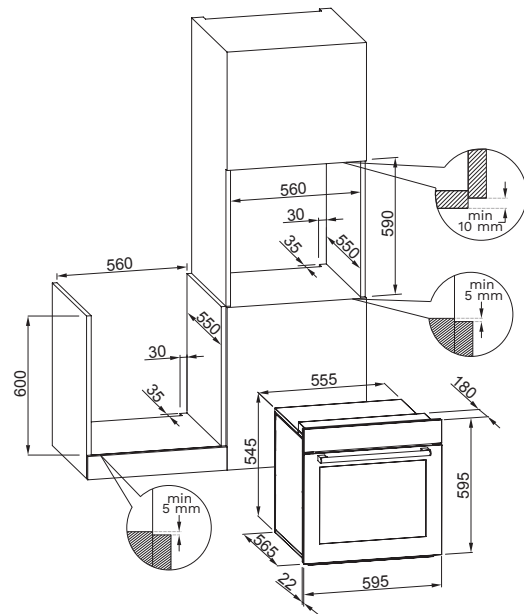

FUNZIONI



PLUS



COLORI*



euro 791

Aluminium FMSP60279NS
M79



euro 791

Titanium FMSP60273NS
M73



euro 791

Bianco FGSP60268NS
G68



euro 791

Avena FGSP60251NS
G51



euro 791

Tortora FGSP60243NS
G43



euro 791

Nero FGSP60240NS
G40

FINITURE



euro 740

Inox FIAP602INNS
IN

*Colori abbinabili ai materiali Granitek

PLUS



PORTA FREDDA



VETRO PORTA REMOVIBILE



CAVITÀ XXL



MANOPOLE SOFT TOUCH



PLUS

LED DISPLAY
LED BIANCHI

10 PROGRAMMI

PLANO MW



Forno microonde multifunzione 10 funzioni

CARATTERISTICHE

Capacità 28 L.
Apertura porta a Sinistra.
Programmatore elettronico con display digitale led bianchi.
Cottura grill/combinata.
Scongelo automatico in base a tempo e peso.
Pulsante di avvio rapido.
Piatto in vetro.
Piatto girevole diametro 315 mm.
Blocco di sicurezza.
Griglia microonde.
Cornice frontale forno in colore.

SICUREZZA

Funzione blocco bambini.

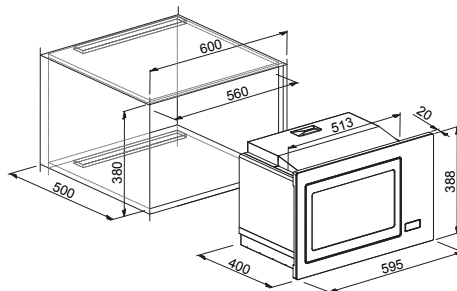

FUNZIONI



PLUS



28
LITRI

COLORI*



euro 768

● **Light Grey** FKSP28197WS
K97



euro 768

○ **White** FKSP28196WS
K96



euro 768

● **Dove Grey** FKSP28193WS
K93



euro 768

● **Black** FKSP28186WS
K86



euro 768

● **Aluminium** FMSP28179WS
M79



euro 768

● **Titanium** FMSP28173WS
M73



euro 768

○ **Bianco** FGSP28168WS
G68



euro 768

● **Avena** FGSP28151WS
G51



euro 768

● **Antracite** FGSP28159WS
G59



euro 768

● **Cemento** FGSP28148WS
G48



euro 768

● **Tortora** FGSP28143WS
G43



euro 768

● **Nero** FGSP28140WS
G40

FINITURE



euro 657

● **Inox** FIAP281INWS
IN

*Colori abbinabili ai materiali Keratek e Granitek

COLLEZIONE
FORNI
COUNTRY



PLUS



PORTA FREDDA



VETRO PORTA REMOVIBILE



CAVITÀ XXL



MANOPOLE E MANIGLIE OTTONATE

COUNTRY **NEW**



Forno elettrico multifunzione 8 funzioni

CARATTERISTICHE

Classe energetica A.
Timer analogico.
Maniglia finitura ottone antico.
Cavità XXL Black 80 litri easy to clean.
6 livelli di cottura.
1 griglia + 1 leccarda.
Luce forno.
Guide cromate laterali.
Porta interna removibile.

COLORI*

Euro 785

Avena
G51

FGC060151NS

SICUREZZA

Porta fredda con triplo vetro.
Ventilazione tangenziale di raffreddamento.

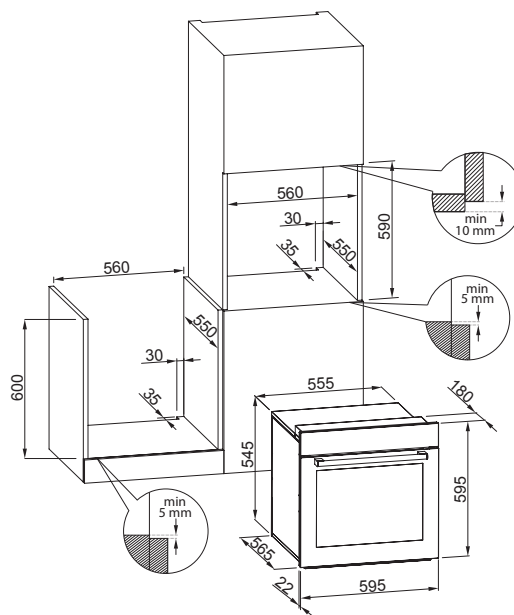

FUNZIONI



PLUS



*Colori abbinabili ai materiali Granitek



FORNI

COLLEZIONE
CAPPE



BRIO



Cappa aspirante smaltata

CARATTERISTICHE

Dimensioni (mm)	782 x 372 x 490
Comandi	Slider
Numero Velocità	3
Portata Massima	368 m3/h
Pressione	218 Pa
Rumorosità Massima	58 dbA
Bocca Uscita	120
Classe Energetica	D

COLORI* Euro 841

 Nero G40	KGPB8040M
--	-----------

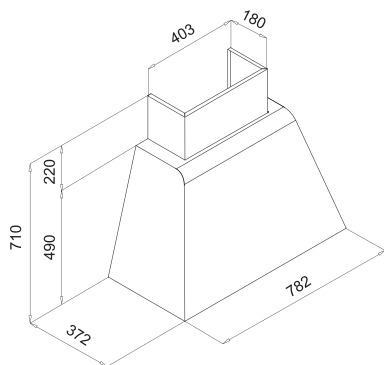

Accessorio filtro carbone Euro 90

AFC01304

URBAN



Cappa aspirante smaltata

CARATTERISTICHE

Dimensioni (mm)	Ø 493 x h 406
Comandi	Slider
Numero Velocità	3
Portata Massima	520 m3/h
Pressione	151 Pa
Rumorosità Massima	65 dbA
Bocca Uscita	120
Classe Energetica	D

COLORI* Euro 723

 Nero G40	KGPUR040M
--	-----------

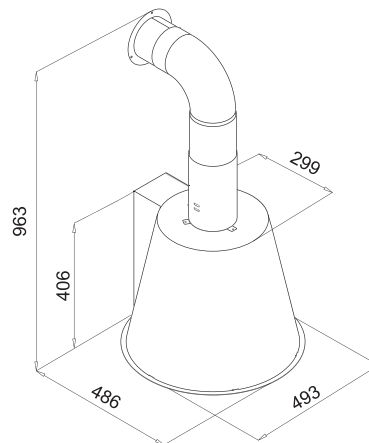

Accessorio filtro carbone Euro 90

AFC01305

*Colori abbinabili ai materiali Granitek

COLLEZIONE
DISSIPATORI

**2 ANNI - YEARS
WARRANTY
GARANTITO**

Il dissipatore di rifiuti alimentari (DRA) è un moderno elettrodomestico essenziale che ci libera dai rifiuti organici e rende la nostra vita più facile in cucina. È sufficiente premere un solo pulsante e il cibo verrà triturato e smaltito. Facile da installare, non ingombrante, silenzioso e sicuro. I rifiuti vengono ridotti in piccole particelle e scaricati nel sistema fognario attraverso l'acqua.

VANTAGGI

Niente più cattivi odori
Risparmio economico
Riduzione dei rifiuti da smaltire
Ambiente più sano
Riduzione CO2

PIÙ SILENZIOSO DEL 40%

Tutti i dissipatori Elleci sono progettati per ridurre al minimo il coefficiente di vibrazione e la rumorosità. Con la combinazione di questi due fattori i dissipatori Elleci sono più silenziosi del 40% rispetto ai prodotti tradizionali.

GRANDE CAMERA DI DISSIPAZIONE

Una cavità volumetrica maggiore comporta un minor rischio di intasamento e una migliore triturazione.

ATTRAVERSO QUESTO ELETTRODOMESTICO È POSSIBILE SMALTIRE RIFIUTI ORGANICI QUALI: FRUTTA, VERDURA, LISCE DI PESCE, GUSCI, OSSA DI POLLO E MOLTI ALTRI.

Non è possibile smaltire cibi fibrosi quali: carciofi, finocchi, ananas, ecc.

STAINLESS STEEL HIGH QUALITY PARTS

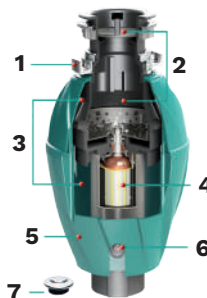

- 1 Installazione facile e veloce
- 2 Protezione Antibatterica e Sistema Antiodore
- 3 Componenti in acciaio inox
- 4 Motore a corrente diretta ad elevata potenza
- 5 Innovativo Design Italiano
- 6 Sistema Reset di Sicurezza
- 7 Interruttore pneumatico ad aria incluso

1000 TOP

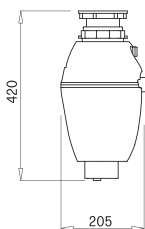

4.8
KG

CARATTERISTICHE

Dimensioni (mm)
205 X 420
Deluxe 1 Hp
TDH01000
Euro **510**

Potenza Watt: 750
Tensione VAC: 220/240
Assorbimento: 3,4
r/min.: 2800
Peso: 4,8
Capacità: 1070 ml.

ACCESSORI INCLUSI



GOMITO DI FISSAGGIO



GOMMA PARASPRUZZI
REMOVIBILE E LAVABILE
(ANCHE IN LAVASTOVIGLIE)



SPINGITORE RIFIUTI



TAPPO
STANDARD



AIR SWITCH:
ATTUATORE PNEUMATICO
(PULSANTE DI ACCENSIONE
AD ARIA, NON ELETTRONICO)

ACCESSORI CONSIGLIATI



FLANGIA DISSIPATORE
PER PILETTA QUADRATA
Pag. 203



RADIOCOMANDO
ACCENSIONE
Pag. 203

750 TOP

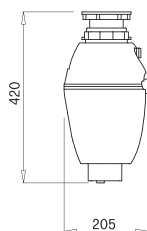

4.7
KG

CARATTERISTICHE

Dimensioni (mm)
205 X 420
3/4 HP
TDH00750
Euro **456**

Potenza Watt: 550
Tensione VAC: 220/240
Assorbimento: 2,5
r/min.: 2800
Peso: 4,7
Capacità: 1070 ml.

750

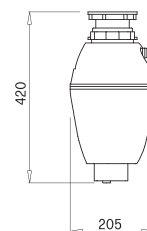

4.5
KG

CARATTERISTICHE

Dimensioni (mm)
205 X 420
3/4 HP
TDM00750
Euro **425**

Potenza Watt: 550
Tensione VAC: 220/240
Assorbimento: 2,5
r/min.: 2800
Peso: 4,5
Capacità: 860 ml.

500 TOP

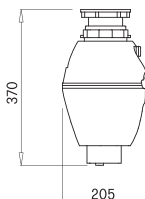

4.5
KG

CARATTERISTICHE

Dimensioni (mm)
205 X 370
1/2 HP
TDM00500
Euro **374**

Potenza Watt: 375
Tensione VAC: 220/240
Assorbimento: 1,7
r/min.: 2800
Peso: 4,5
Capacità: 1070 ml.

500

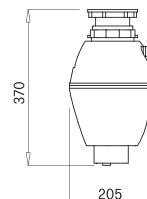

4.3
KG

CARATTERISTICHE

Dimensioni (mm)
205 X 370
1/2 HP
TDM00500
Euro **352**

Potenza Watt: 375
Tensione VAC: 220/240
Assorbimento: 1,7
r/min.: 2800
Peso: 4,3
Capacità: 860 ml.



Una linea di prodotti, con specifiche caratteristiche, realizzati per facilitare le operazioni quotidiane di pulizia e cura delle superfici per mantenere nel tempo la bellezza dei prodotti Elleci.

elleci | BEAUTY



SCORPI DI PIÙ



DLL01602
28 Euro
0,2 LT/KG **NEW**

DAILY CLEANER – SGRASSANTE
Detergente spray sgrassante, rimuove tracce di sporco, germi e batteri rispettando le superfici. È indicato per la pulizia periodica dei lavelli in composito Elleci.



DLC01603
38 Euro
0,2 LT/KG **NEW**

DEEP CLEANER – EXTRA ACTION
Detergente in crema con azione smacchiante, rimuove le macchie più ostiche su tutti i lavelli Elleci in composito di colore chiaro.



DLA01603
28 Euro
0,2 LT/KG **NEW**

DAILY CLEANER – ANTICALCARE
Detergente spray anticalcare, scioglie le incrostazioni rispettando le superfici. È indicato per una pulizia periodica dei lavelli Elleci in composito.



DLP01601
30 Euro
0,1 LT/KG **NEW**

BEAUTY PROTECTOR
Detergente spray protettivo, salvaguarda da sporco, residui calcarei e mantiene la bellezza del prodotto nel tempo ravvivando la colorazione e aumentandone l'idrorepellenza.



ESPOSITORE DA BANCO PRODOTTI PER LA PULIZIA
Un comodo box impilabile in cartone disponibile su richiesta.



DLA01602
30 Euro
0,25 LT/KG

DAILY CLEANER – CLEAN POWER
Detergente spray di pulizia specifico per superfici colorate e smaltate. È indicato per una pulizia quotidiana dei miscelatori e degli elettrodomestici colorati Elleci.



DKP01000
18 Euro

FAST CLEAN – KIT SPUGNE
Kit composto da 3 spugne antigraffio dotate di doppio strato utile a rimuovere lo sporco, anche il più intenso. La parte bianca agisce senza graffiare le superfici delicate, mentre la parte blu più morbida, ha un potere assorbente.



DKP01001
24 Euro

FAST CLEAN – PANNI IN MICROFIBRA
Kit composto da 2 panni in microfibra con speciale motivo a scacchiera ad alta assorbenza per lasciare asciutto il lavello e togliere ogni residuo lasciando inalterata la superficie.

CURA E MANUTENZIONE



Mantenere nel tempo l'estetica e la funzionalità del prodotto è estremamente semplice. È sufficiente pulire ed asciugare quotidianamente utilizzando detergenti neutri o specifici della linea **Elleci Beauty** senza lasciare che depositi e residui agiscano a lungo sulle superfici.



ULTERIORI
AVVERTENZE
E CONSIGLI



Rimuovere eventuali macchie utilizzando una spugna morbida e un detergente neutro per i piatti o un prodotto specifico della linea Elleci Beauty.



Risciacquare abbondantemente le superfici utilizzando acqua tiepida.



















Asciugare con cura la superficie con un panno morbido o in microfibra per impedire la formazione di depositi di calcare.



Per prevenire la formazione delle macchie di calcare sulla superficie, si raccomanda di eseguire una pulizia più approfondita una o due volte alla settimana utilizzando un detergente anticalcare disincrostante come lo spray anticalcare Daily Clean della linea Elleci Beauty.

SPARE PARTS

	SET PILETTA FLOW PRO INOX, UNA VIA SCARICO PILETTA UNA VIA DA 3-1/2" CON TAPPO CESTELLO FLOW PRO INOX E TUBO CORRUGATO, SENZA TROPPOPIENO	CODICE WPT90CTPLUXF	EURO 35,00
	SET TROPPOPIENO RETTANGOLARE TROPPOPIENO CON USCITA RETTANGOLARE SLIM E COVER INOX, COMPLETO DI ATTACCHI	CODICE KTSMELL	EURO 10,00
	SET PILETTA FLOW PRO CON TROPPOPIENO SLIM NERO SCARICO PILETTA UNA VIA DA 3-1/2" CON TAPPO CESTELLO FLOW PRO NERO E TUBO CORRUGATO CON TROPPOPIENO SLIM "ELLECI" NERO	CODICE KITWPT-F-1VSELL-BK	EURO 115,00
	SET PILETTA FLOW PRO CON TROPPOPIENO SLIM GOLD SCARICO PILETTA UNA VIA DA 3,1/2" CON TAPPO CESTELLO FLOW PRO GOLD E TUBO CORRUGATO CONTROPPOPIENO SLIM "ELLECI" GOLD	CODICE KITWPT-F-1VSELL-GD	EURO 95,00
	TAPPO SCARICO FLOW PRO INOX TAPPO CESTELLO FLOW PRO INOX SPAZZOLATO	CODICE TAPF01IN	EURO 25,00
	TAPPO SCARICO FLOW PRO NERO TAPPO CESTELLO FLOW PRO NERO	CODICE TAPF01BK	EURO 95,00
	TAPPO SCARICO FLOW PRO GOLD TAPPO CESTELLO FLOW PRO GOLD	CODICE TAPF01GD	EURO 70,00
	SET PILETTA UNA VIA INOX SCARICO PILETTA UNA VIA DA 3-1/2" CON TAPPO CESTELLO E TUBO CORRUGATO, SENZA TROPPOPIENO	CODICE WBB90CTPLUXR	EURO 10,00
	SET PILETTA CHIUSA INOX SCARICO PILETTA 3-1/2" CHIUSA CON TAPPO CESTELLO	CODICE WBB90STPLUXR	EURO 10,00
	SET PILETTA UNA VIA, SCARICO QUADRATO SCARICO PILETTA QUADRATA UNA VIA CON TUBO CORRUGATO, SENZA TROPPOPIENO	CODICE WPT90CTPLUXQ	EURO 40,00
	SET PILETTA SCARICO PILETTA CHIUSA DA 70mm, CON TAPPO CESTELLO, SET ESCLUSIVO PER LAVELLI EASY 325 e EASY 425	CODICE WPT70STPLUXA	EURO 12,00
	SET TROPPOPIENO TONDO TROPPOPIENO CON USCITA TONDA E COVER INOX, COMPLETO DI ATTACCHI	CODICE KTTMELL	EURO 8,00
	SET SIFONERIA UNA VIA SIFONE ISPEZIONABILE SALVASPAZIO A UNA VIA PER LAVELLI UNA VASCA	CODICE COMPSIF1V	EURO 8,00
	SET SIFONERIA DUE VIE SIFONE ISPEZIONABILE SALVASPAZIO A DUE VIE PER LAVELLI DUE VASCHE	CODICE COMPSIF2V	EURO 10,00
	SET SIFONERIA DUE VIE SFASATE SIFONE ISPEZIONABILE SALVASPAZIO A DUE VIE SFASATE, PER LAVELLI CON DUE VASCHE	CODICE COMPSIF2VU	EURO 10,00
	SET GANCI SOPRATOP N°6 GANCI FISSAGGIO AD INCLINAZIONE 23° CON VITI PREMONTATE E SPESSORI IN PLASTICA, PER FISSAGGIO LAVELLO COMPOSITO	CODICE BOXGAN06	EURO 12,00

LAVELLI IN COMPOSITO

	SET GANCI SOPRATOP N°6 GANCI FISSAGGIO AD INCLINAZIONE 90° CON VITI PREMONTATE E SPESSORI IN PLASTICA, PER FISSAGGIO LAVELLO COMPOSITO	CODICE BOXGAN06S	EURO 12,00	LAVELLI IN COMPOSITO
	SET GANCI SOTTOTOP N°6 GANCI FISSAGGIO CON VITI PER LAVELLO COMPOSITO AD INSTALLAZIONE SOTTOTOP	CODICE AKS01301	EURO 18,00	
	FRESA PER FORATURA FRESA A TAZZA DIAMANTATA, DIAMETRO 35mm PER EFFETTUARE FORO MISCELATORE SU LAVELLO COMPOSITO	CODICE FRES17	EURO 18,00	
	ESPOSITORE DA BANCO PRODOTTI PER LA PULIZIA BOX CARTONE SET PRODOTTI PER LA PULIZIA	SU RICHIESTA		
	SET PILETTA QUADRATA UNA VIA CON TROPPOPIENO RETTANGOLARE SCARICO PILETTA QUADRATO CON TUBO CORRUGATO E TROPPOPIENO RETTANGOLARE SLIM	CODICE COMPP90CTPLUXW	EURO 40,00	LAVELLI INOX
	SET PILETTA UNA VIA CON TROPPOPIENO RETTANGOLARE SCARICO PILETTA 3-1/2" CON TUBO CORRUGATO E TROPPOPIENO RETTANGOLARE SLIM	CODICE COMPP90CTPLUXC	EURO 12,00	
	TAPPO TAPPO DISSIPATORE TONDO	CODICE IKT90004	EURO 15,00	DISSIPATORI
	SET FLANGIA RACCORDO FLANGIA DI RACCORDO PER DISSIPATORE ELLECI CON GUARNIZIONI, PARASCHIZZI IN GOMMA, ANELLO E GHIERA DI FISSAGGIO	CODICE IKT90001	EURO 20,00	
	FLANGIA DI RACCORDO QUADRATA PER DISSIPATORE ELLECI PER LAVELLI CON SCARICO QUADRATO	CODICE ATQ01300	EURO 38,00	
	FLANGIA MAGGIORATA FLANGIA DI RACCORDO CON FILETTATURA AUMENTATA, PER INSTALLAZIONE DISSIPATORE SU SUPERFICI CON SPESSORE MAGGIORATO	CODICE MLT90007	EURO 65,00	
	SET GOMITO FISSAGGIO GOMITO DI FISSAGGIO CON GUARNIZIONI	CODICE IKT90003	EURO 18,00	
	SET PULSANTE PNEUMATICO PULSANTE PNEUMATICO CON TUBO IN GOMMA E DADO DI FISSAGGIO, PER L'ACCENSIONE DEL DISSIPATORE	CODICE IKT90002	EURO 30,00	
	PARASCHIZZI PARASCHIZZI IN GOMMA CON ALETTE	CODICE PPT90010	EURO 10,00	
	RADICOMANDO RADIOCOMANDO ACCENSIONE DISSIPATORE	CODICE ARP01300	EURO 84,00	
	SPINGITORE RIFIUTI SPINGITORE RIFIUTI IN PLASTICA	CODICE PPT90000	EURO 18,00	
	MANOPOLA SILVER MANOPOLA SILVER PER PIANI COTTURA PLANO	CODICE AMP06300	EURO 13,00	

ELLECI È SEMPRE PIÙ VICINA A TE

Elleci ha cura dei propri clienti e lo dimostra utilizzando i materiali più innovativi e le tecnologie più all'avanguardia per offrire il massimo della qualità.

Qualità certificata da precise norme di produzione, conformi a ISO 9001:2015, ISO 14001:2015 e ISO 45001:2018.

Elleci ti assicura una garanzia della durata variabile, a seconda della categoria del prodotto che hai scelto.

Tali durate sono indicate nei rispettivi manuali di utilizzo/installazione.

PRODOTTO	GARANZIA
LAVELLI COMPOSITO GARANZIA 2 ANNI* _ KERATEK	20 ANNI
LAVELLI COMPOSITO GARANZIA 2 ANNI* _ GRANITEK	10 ANNI
LAVELLI INOX / MISCELATORI / ELETTRODOMESTICI / ACCESSORI	2 ANNI
DISSIPATORI	2 ANNI

* Elleci offre ai suoi clienti la possibilità, previa registrazione prodotto, di usufruire anche della garanzia convenzionale (oltre quella legale) di 10 anni per i lavelli in Granitek e 20 anni per i lavelli in Keratek.

MODALITÀ DI ASSISTENZA TECNICA

LAVELLI | MISCELATORI | ACCESSORI | DISSIPATORI

In caso di assistenza tecnica su lavelli in composito, lavelli inox, miscelatori, accessori e dissipatori, e dopo l'inserimento dei necessari dati e documentazioni, il Customer Care elaborerà la pratica, fornendoti riscontro entro le 48 ore successive.

Se la pratica rientra in garanzia, essa verrà conclusa nell'arco dei 7 giorni successivi alla data dell'invio della mail con la comunicazione dell'esito della pratica stessa.

PIANI COTTURA | FORNI | CAPPE

In caso di segnalazioni riguardanti gli elettrodomestici (piani cottura, forni e cappe), esse verranno gestite tramite circa 350 centri di assistenza tecnica (CAT) da noi appositamente incaricati. Anche in questo caso, dopo aver fornito i necessari dati e documentazioni, il Customer Care Elleci prenderà contatto con te entro le 48 ore successive alla segnalazione per definire e concordare le successive tempistiche di uscita e/o di risoluzione pratica.

UN NUOVO NUMERO VERDE
A TUA DISPOSIZIONE,
UN NUOVO SERVIZIO DI ASSISTENZA
PRE E POST-VENDITA

Elleci ha potenziato il suo Customer Care, un vero e proprio team di professionisti pronto ad offrirti un servizio ancora più tempestivo ed efficiente. Un solo numero verde per gestire tutte le richieste, attivo dal lunedì al venerdì dalle 8.30 alle 13.00 e dalle 14.00 alle 17.30, e raggiungibile sia da numero fisso sia da smartphone.











Il Customer Care Elleci sarà al tuo fianco in modo rapido e affidabile, provvedendo a trovare la soluzione più idonea per garantire la tua piena soddisfazione.

NUMERO VERDE
800 800 803











Per maggiori informazioni
visita il sito www.elleci.com

LAVELLI



-  Base
-  Base
SE INIZIO COMPOSIZIONE SX
-  Base
SE INIZIO COMPOSIZIONE DX
-  Sottotop
-  Filotop
-  Flat
-  Appoggio
-  Profondità 1 vasca
-  Profondità 2 vasche
-  Vasca XL

MISCELATORI



-  Green
-  Inox AISI 304
-  Cambio getto
-  Doccetta
-  Reclinabile
-  Funzionamento leva 90°
-  Rotazione 360°
-  Full colour

FORNI

-  Classe energetica
-  Vano cottura XL
-  Defrost con illuminazione
-  Fan Defrost
-  Resistenza superiore e inferiore ventilata
-  Resistenza circolare ventilata
-  Resistenza inferiore ventilata
-  Resistenza inferiore e resistenza circolare ventilata
-  Grill doppia resistenza superiore ventilata
-  Grill
-  Doppio grill
-  Resistenza inferiore e superiore
-  Resistenza inferiore
-  Resistenza superiore
-  Steam clean
-  Cottura pizza
-  Funzione riscaldamento
-  Cottura patate
-  Cottura carne
-  Cottura pesce
-  Cottura verdura
-  Riscaldamento bevande

-  Cottura pasta
-  Preparazione popcorn
-  Cottura pollo

DISSIPATORI

-  Go green
-  Sistema antiiodori
-  Sistema di sicurezza

REALIZZATO DA ELLECI S.P.A.

in collaborazione con

ARCHÈ AGENCY S.R.L.

TIPOGRAFIA LUCE

Stampa

Stampato su carta certificata FSC.

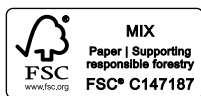

IL CATALOGO È PROPRIETÀ DI ELLECI S.P.A. TUTTI I DIRITTI SONO RISERVATI.

Sono tassativamente vietate le riproduzioni del presente catalogo, anche parziali, per fini commerciali senza specifica autorizzazione da parte di Elleci.

Elleci S.p.A. declina ogni responsabilità per possibili errori o inesattezze contenute nel catalogo, oltre a precisare che le immagini inserite e i dati forniti sono puramente indicativi.

LA STAMPA TIPOGRAFICA NON SEMPRE RIPRODUCE FEDELMENTE LE TINTE ED I MATERIALI ORIGINALI.

La riproduzione dei colori è PERTANTO da ritenersi puramente indicativa.

ELLECI S.P.A. SI RISERVA DI APPORTARE IN QUALSIASI MOMENTO E SENZA PREAVVISO MODIFICHE RITENUTE UTILI AL MIGLIORAMENTO DEI PROPRI PRODOTTI PRESENTI SU QUESTO CATALOGO.

I prezzi riportati nel presente Catalogo Listino sono al netto di IVA, trasporto ed eventuale ECO-Contributo RAEE.

Per l'installazione, l'utilizzo e la manutenzione dei prodotti acquistati, attenersi scrupolosamente a quanto riportato nel libretto di istruzione e manutenzione contenuto nella confezione. Non seguire scrupolosamente quanto indicato nei manuali di uso e manutenzione potrebbe comportare un decadimento delle prestazioni del prodotto e la esclusione della garanzia.

I prodotti contenuti all'interno di questo catalogo sono realizzati con la finalità di ottenere una fedeltà cromatica attraverso tecnologie costruttive differenti, per questo motivo eventuali variazioni nelle tonalità dei prodotti sono da attribuire al diverso materiale di base e rientrano in un range di tolleranza.

Every day choices make your life.